



**VRV**  
PRODUCT  
CATALOG

Setting Daikin's new standards in  
indoor comfort and efficiency



# Table of Contents

## Overview

Why choose Daikin?	5
What is Daikin VRV?	6
Why choose Daikin VRV?	7
Which VRV System Offers the Best Solution?	8
Setting the Standards	10
Daikin VRV	12
Setting the Standards, Again	12
What does a VRV installation mean to you?	24
Vertical Market Applications	26

## Product Portfolio

Outdoor Units	30
Indoor Units	32
Accessories	34

## Indoor units

Indoor Units Overview	44
FXMQ_PBVJU - HSP DC Concealed Ducted Unit	46
FXSQ_TAVJU - MSP Concealed Ducted Unit	48
FXDQ_MVJU - LSP Slim Concealed Ducted Unit	50
FXTQ_TAVJU Multi-Position Air Handling Unit	52
FXMQ_MVJU - HSP High Capacity Concealed Ducted Unit	54
FXNQ_MVJU9 - Concealed Floor-Standing Unit	56
FXFO_TVJU - Round Flow Sensing Cassette	58
FXUQ_PVJU - 4-Way Ceiling-Suspended Cassette	62
FXZQ_TAVJU - VISTA™ 2x2 Cassette	64
FXEQ_PVJU - Ceiling-Mounted Cassette	66
FXHQ_MVJU - Ceiling-Suspended Unit	68
FXAQ_PVJU - Wall-Mounted Unit	70
FXLQ_MVJU9 - Floor-Standing Unit	72
DZK Zoning Kit for VRV Indoor Units	74

## Outdoor units

VRV IV X - Air-Cooled Heat Recovery	80
VRV IV X Indoor Units 80-97% AFUE Communicating Gas Furnace	84
VRV A-Coil CXTQ_TASBLU	84
Daikin VRV AURORA™ Heat Recovery	86
Daikin VRV AURORA™ Heat Pump	90
VRV IV - Air-Cooled Heat Recovery	94
VRV IV - Air-Cooled Heat Pump	98
VRV T-Series Water-Cooled Systems	102
VRV IV S - Series - Heat Pump	108
VRV IV, I VRV III PC, VRV T-Series Water-Cooled Systems, & VRV IV-S - Installation Space	110
VRV IV, VRV III PC, VRV T-Series Water-Cooled Systems, & VRV IV-S - Piping Length	112

4 VRV Accessories	114
Branch Selector Boxes	114
REFNET Pipe Joints	116
Hail Guard Kit for VRV IV	117
AHU (Air Handling Kit) Integration Kit	118
Control Box EKE_CBAV3-US	120

## Ventilation

FXMQ_MFVJU - 100% Outside Air Processing Unit	126
VAM-GVJU - Energy Recovery Ventilator	128
DVS Dedicated Outside Air System	130

## Controls

VRV Controls Solution	132
VRV Controls Systems Overview	134
Individual Controllers	136
BRC1E73 - Navigation™ Remote Controller	136
BRC4C82/BRC7E818/BRC7E83/BRC7E830 - Wireless Remote Controller	140
AZAI6WSCDKA-DKN Cloud Wi-Fi Adaptor	140
BRC2A71 - Simplified Remote Controller	140
Advanced Multi-Zone Controllers	142
DCM601A71 - intelligent Touch Manager™ (iTM)	142
DCS601C71 - intelligent Touch Controller™ (iTIC)	144
Centralized Controllers	146
DCS302CT1 - Central Remote Control	146
DCS301C71 - Unified ON/OFF Controller	147
DST301BA61 - Schedule Timer	147
External Equipment Control	148
DCM009A51 - iTM™ BACnet® Client Option	148
750-831 - Daikin WAGO® BACnet®/IP Controller	149
Interface Solutions	150
DCM014A51 - iTM™ BACnet® Server Gateway Option	150
DMS502B71 - Interface for use BACnet®	152
DMS504C71 - Interface for LonWorks®	152
DTA116A51 - DIII-Net/Modbus® Adaptor	152
VRV Monitoring Services	153
D-NET Air Conditioning Network Service System	153
Controls Product List	154
<b>Support and Tools</b>	<b>157</b>
Support and tools overview	158
Selection software	159
Energy screening and simulation tools	160
Design and verification	161
Online and tablet reference material	161
Smartphone and mobile reference	162
After sales and service	163

OVERVIEW

PRODUCT PORTFOLIO

INDOOR UNITS

OUTDOOR UNITS

VENTILATION

CONTROLS

SUPPORT & TOOLS



# Why choose Daikin?

## A history of industry-leading product innovation

Becoming a global leader in any industry takes more than just time. For over 90 years Daikin has shown that it takes industry-leading product innovation and a commitment to excellence in order to climb to the top. This commitment led Daikin to develop the first Variable Refrigerant Volume (VRV) system in 1982 and to become a pioneer with our Variable Refrigerant Volume systems.

## Daikin's 3 core technologies

Daikin is an industry-leading HVAC technology company. We develop state-of-the-art technology that provides indoor comfort solutions for our customers. We do this by focusing on 3 core technologies. Our refrigerant control technology provides an efficient and effective way to transport heat. Daikin inverter technology allows us to maximize energy efficiency and heat pump technology provides an effective method for moving refrigerant.

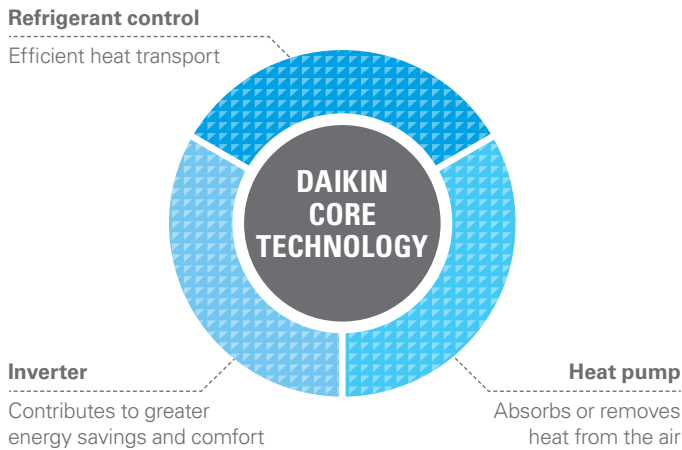

## The total solution

Daikin's products and controls are designed to provide a flexible, scalable, total indoor comfort solution. We are committed to supporting our customers at every phase of the project to ensure that the highest quality and most cost effective solution is the one that is provided. From project conception throughout the life of an HVAC system, Daikin provides world class products and support. A single source and total solution for your HVAC requirements.



# What is Daikin VRV?

## One flexible package

Daikin VRV is a modular, commercially applied air-conditioning and heating system that distributes refrigerant from the outdoor unit to multiple indoor units, providing efficiency, comfortable individual user control and reliability in one flexible package.

Daikin VRV systems provide advanced solutions for almost any large residential to commercial application. Available in air-cooled or water-cooled solutions and heat recovery or heat pump systems, VRV provides advanced heating and cooling options with individual zone control for both open plan and tightly grouped applications.

VRV is built upon 4 basic "Building Blocks" — Outdoor Unit, Indoor Unit, Piping, and Controls — providing the attributes of a central chilled water system but with the simplicity of a split system.

This makes it very flexible and ideal for energy-efficient and comfortable cooling and heating of many types of buildings such as banks, health care, skilled care, libraries, storage facilities, conference centers, etc.



Outdoor Unit



Indoor Unit



Piping



Controls

### Applications

- » Multi-family residences
- » Retail
- » Hotels
- » Office buildings
- » Schools, etc.



## Inventor and leader in VRV systems since 1982

### Unique products that make the difference

#### » In efficiency

- Variable Refrigerant Temperature (VRT) technology leading to excellent energy efficiency
- Indoor units with advanced sensing technology and optional self-cleaning air filter panel

#### » In comfort

- Variable Refrigerant Temperature technology preventing cold draughts
- 13 different indoor unit types and 81 models
- Low sound indoor and outdoor units

#### » In aesthetics

- Stylish cassettes integrated in the ceiling
- Ceiling suspended cassettes
- Elegant wall mounted units

#### » In installation

- Automatic refrigerant charge function
- Self-addressing control system after installation
- VRV Configurator for simplified and time saving commissioning
- Flexible connection possibilities for indoor and outdoor units

#### » In control

- intelligent Touch Manager™ (iTM)— a mini-BMS/Centralized Controller that integrates all units in a cost-efficient system
- Easy integrating with third party BMS
- Dedicated control solutions for applications such as offices, shops, hotels, schools, etc.

#### » In system design

- User friendly sizing and selection software
- CAD drawings and Revit\* families
- Comprehensive engineering manuals

#### » In after market support

- Nationwide field support organization
- 50+ product training facilities in North America
- Dedicated tech support team

#### » In reliability

- Refrigerant-cooled electronics in outdoor unit
- Extensive testing before new units leave the factory
- Spare parts available in the US
- ISO 9001 compliant manufacturing
- One of the best warranties\*\* in the industry

\* Visit [bim.daikincity.com](http://bim.daikincity.com) for Revit families

\*\* Complete warranty details available from your local Daikin manufacturer's representative or distributor or online at [www.daikincomfort.com](http://www.daikincomfort.com) or [www.daikinac.com](http://www.daikinac.com).



# Which VRV System Offers the Best Solution?

## Air-cooled or water-cooled?

### Air-cooled

- » Fast and easy to install — no need for additional components
- » Low maintenance costs
- » Can be installed both outdoors and indoors
- » Up to 38 tons capacity for one system

Components:

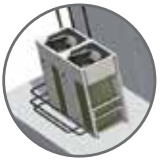

Outdoor unit

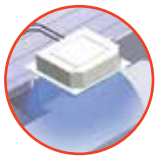

Indoor unit

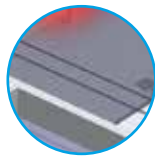

Refrigerant piping

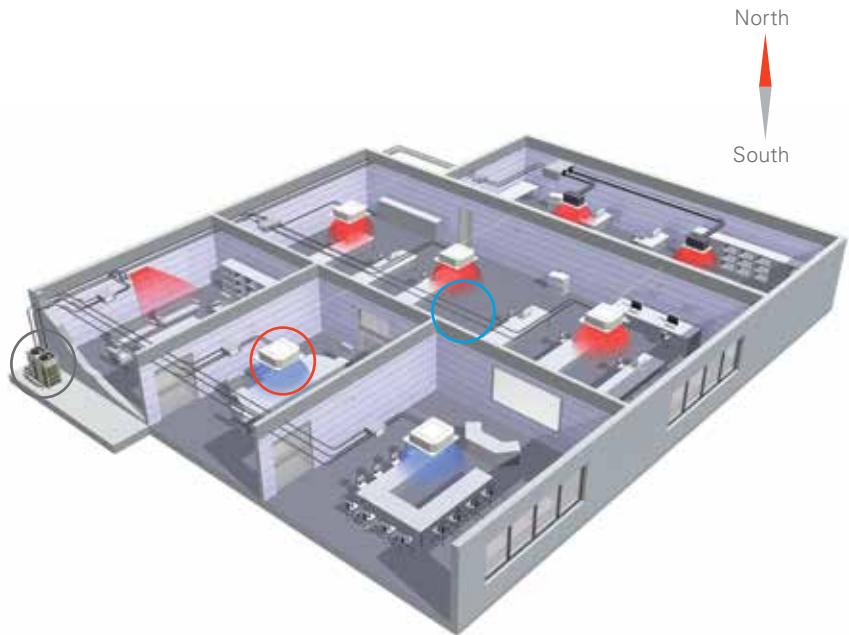

### Water-cooled

- » Suitable for multi-story and large buildings because of the almost unlimited possibilities of water piping
- » Not affected by outdoor temperature/climate conditions
- » Reduce CO<sub>2</sub> emissions thanks to the possibility of geothermal energy as a renewable energy source

Components:



Condensing unit

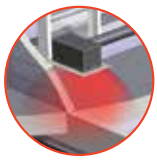

Indoor unit



Refrigerant piping



(Geothermal) water loop





## Heat Recovery or Heat Pump?

### VRV Heat Recovery

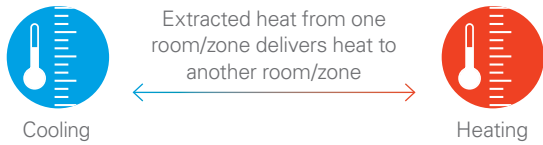

- » Simultaneous heating AND cooling from one system
- » Efficient heating by transferring heat rejected by cooling zones to those requiring heating.
- » Maximum individual comfort in all areas

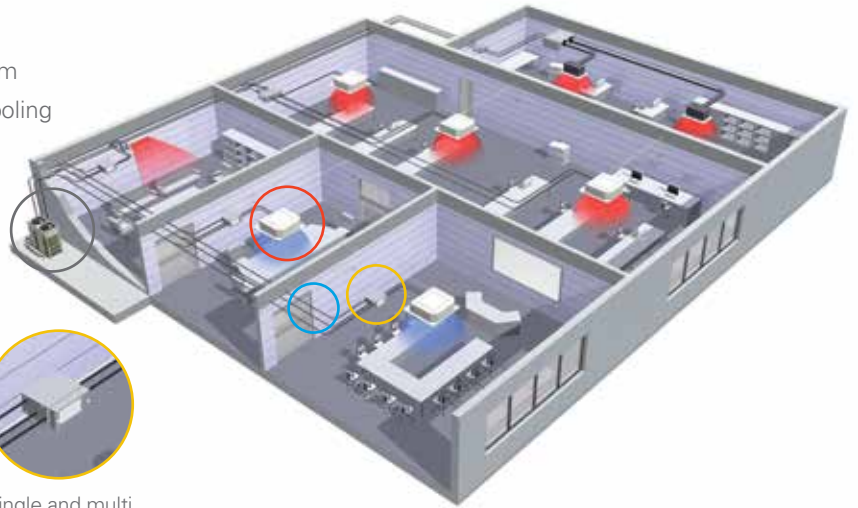

Components:



Outdoor unit



Indoor unit

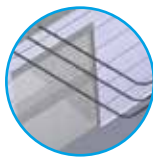

3-pipe refrigerant piping

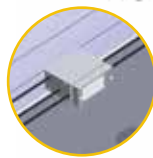

Single and multi Branch Selector boxes: allows the individual switching of indoor units between heating and cooling

### VRV Heat Pump

- » For either heating OR cooling operation from one system

Components:



Outdoor unit



Indoor unit

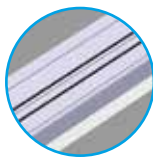

2-pipe refrigerant piping

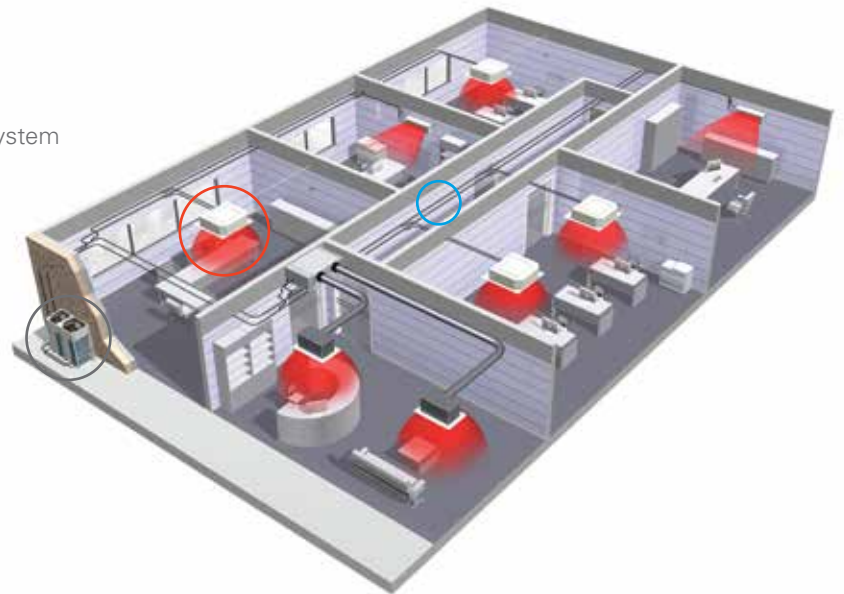

# Setting the Standards

## Over 30 years of VRV history

Daikin invented the first VRV system in 1982 and has continued to set standards in the industry and heighten market expectations. Many of the current market expectations are:

- » Energy efficient inverter compressor
- » Modular system concept
- » Heat recovery function
- » Allow long piping lengths
- » Heating operation down to -13°F ambient air temperature as standard
- » Continuous heat during defrost
- » Auto charge at start up

VRV was invented in 1982 as a result of the oil crisis around the world in the 70's. Energy efficiency laws were passed by the Japanese government. The Japanese government and Daikin worked closely together — they looked at a chiller system; pumps, and air handlers as well and how the pump circulates water and how it uses a lot of power. So, they came up with a concept to use refrigerant instead of water to circulate as a heat transfer medium. The first VRV heat recovery system was launched in 1991 implementing the landmark concept of a heat pump chiller that circulates refrigerant instead of water.

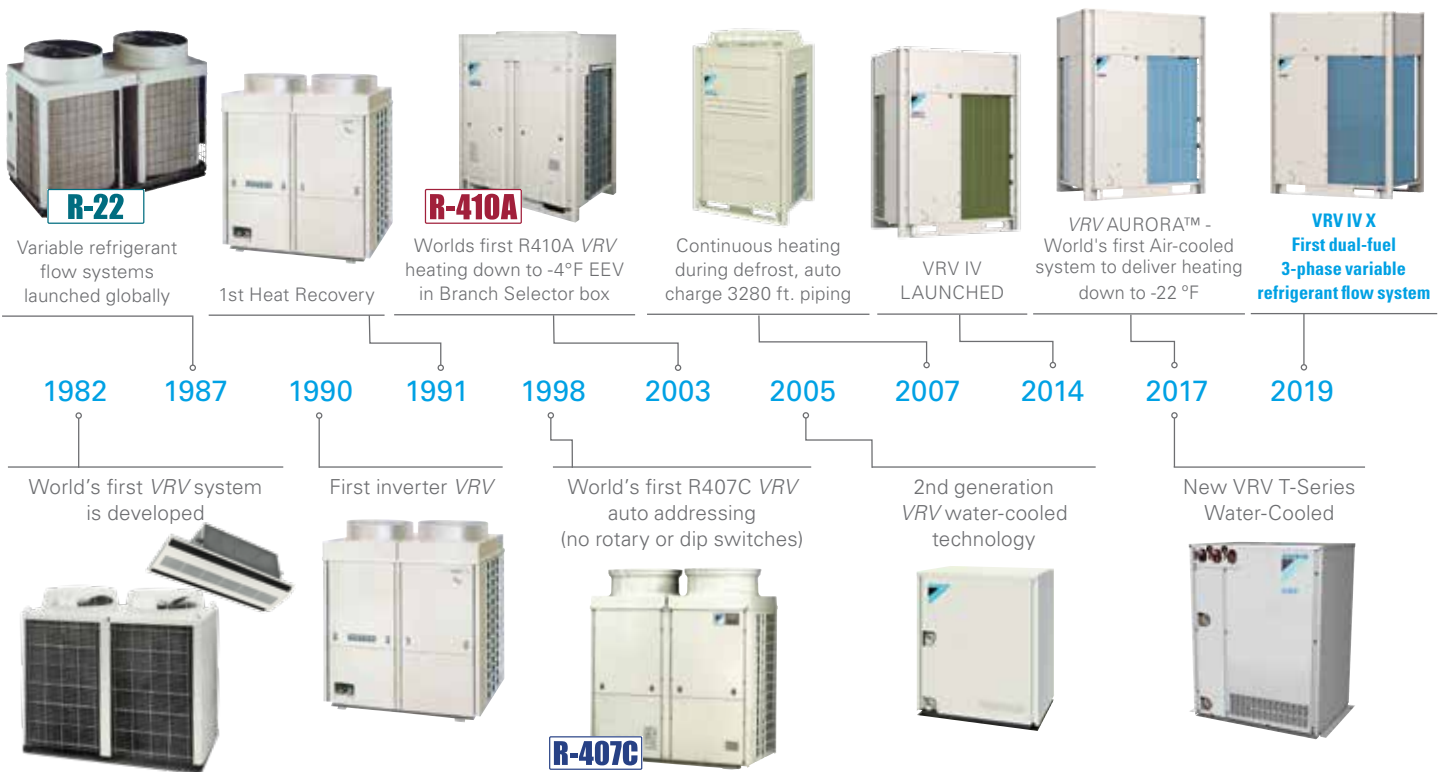

Our quality control is based on the idea that the added value we give to products is quality, and that this quality is what customers are buying. And each Daikin employee constantly puts quality ahead of everything else.



# Daikin VRV

## Setting the Standards, Again



Daikin VRV sets the standard with the latest technology and time saving commissioning & servicing

### Optimized life cycle cost

The features of a Daikin VRV system, energy efficient and easy to design, install, and maintain, means that it is designed to reduce the total life cycle cost.

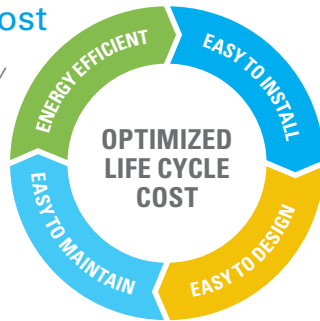

### Optimized for the North American market needs

Engineered and assembled in North America Daikin's VRV IV X adapts VRV to North American HVAC market needs by expanding the applications in which VRV can be leveraged to solve traditional challenges. Packed with advanced technology, VRV IV X is the industry's first 3-phase variable refrigerant flow system with dual-fuel capability, after Daikin's launch of 1-phase VRVLIFE™ in 2018. The new series is equipped with features to optimize initial capital required on phased installations and provides ease of service and maintenance.

VRV Heat Pump and Heat Recovery - Single, dual, and triple modules

		CAPACITY - TONS																
		6	8	10	12	14	16	18	20	22	24	26	28	30	32	34	36	38
VRV IV Heat Pump	VRV IV Heat Pump																	
	VRV IV X Heat Recovery																	

## VRV IV X - Adapting VRV to North American market needs

### Gas Furnace Connectivity

Expanding VRV into applications that were limited to gas-based heating, VRV IV X is the first 3-phase dual-fuel variable refrigerant flow system in North America that integrates with communicating gas furnaces.

VRV IV X offers outstanding design flexibility when connected to Daikin communicating 80%, 96%, and 97% AFUE gas furnaces and CXTQ coils. The new VRV IV X enables the use of VRV technology to provide utility cost based heating solutions. With the flexibility to switch between electric heat pump heating and gas heating, operational costs can be optimized to building owner's choice for a heating source.

- » Space-saving with ability to connect multiple gas furnaces to one outdoor unit with 14 selectable settings.
- » Customizable changeover temperatures to switch from heat pump to gas heat.
- » Ability to provide system-wide heating independent of outdoor ambient temperature.



### Phased Installation

VRV IV X delivers enhanced design flexibility thanks to its ability to expand with the building's phased construction.

- » Expand the system from a single to a dual module or from dual to triple module without changes to main pipe sizes that are already installed.
- » Help reduce initial capital and design complexity compared to systems that do not offer phased installation.
- » Optimize piping design, branch selector boxes, and indoor units per phase of installation.

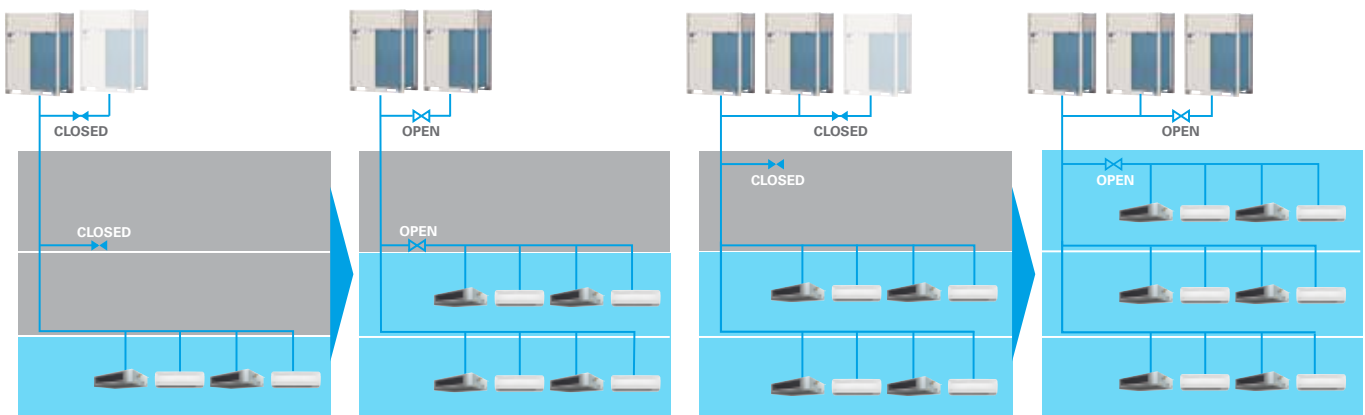

# Daikin VRV

## Setting the Standards, Again (cont.)



### VRT (Variable Refrigerant Temperature) – State-of-the-art energy-saving technology for VRV

#### Adaptive and learning VRT

The new VRV IV X system features a newly enhanced learning VRT technology. The new learning VRT technology, in addition to helping with annual energy efficiency and maintaining comfort, provides features that enable time-based learning to adjust cooling and heating capacities to provide a stable capacity to the indoor units. The feature must be activated through field setting changes.

#### How is energy reduced?

A standard variable refrigerant flow system and previous Daikin VRV systems utilize a capacity based control logic where the system will adjust to meet the capacity requirements of the space. With VRT, Daikin has optimized focus not only on capacity but also on efficiency and comfort.

According to changes in the room's heat load and the ambient air temperature, the evaporating temperature (in cooling)

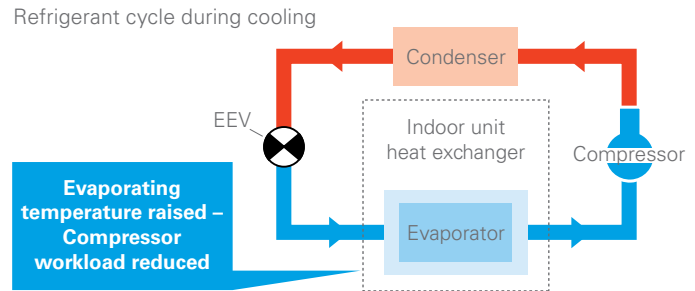

and condensing temperature (in heating) are automatically adjusted to minimize the difference with the condensing temperature and the evaporation temperature, respectively.

This makes the compressors work less and also enables the system to always maintain the ideal compressor speed so that the Daikin VRV system can deliver the optimum efficiency.

Case study – Measured monthly energy usage for a VRV system without VRT and with VRT, installed in a European retail shop

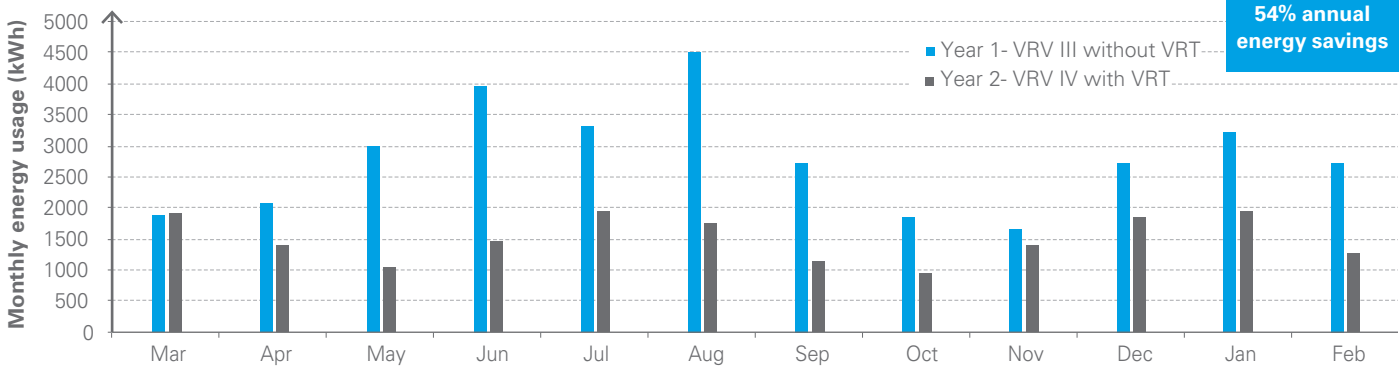

Heating degree days and cooling degree days, that are quantitative indications reflecting demand for energy to heat or cool buildings, were the same for year 1 and year 2.

The basis to determine whether a specific day is a heating degree day or a cooling degree day is the daily average ambient air temperature. Even the average min/max ambient air temperature were very similar for year 1 and year 2.

Ambient air temperature

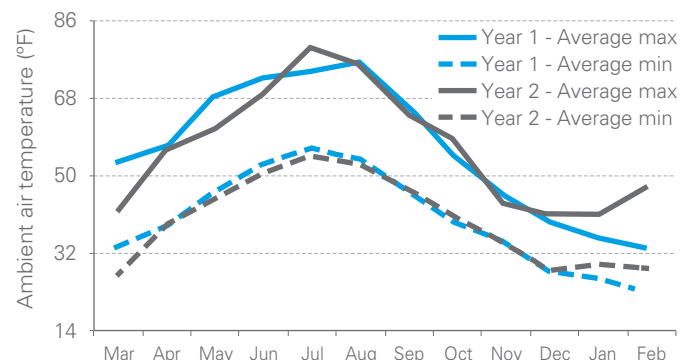

Fine control to match user preference available through mode selection

Basic mode is selected to maintain optimal comfort. VRT is selected to save energy and prevent excessive cooling.

**Capacity priority**

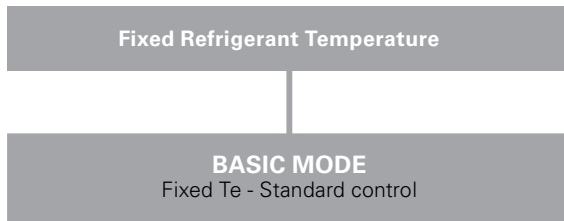

**Energy saving priority**

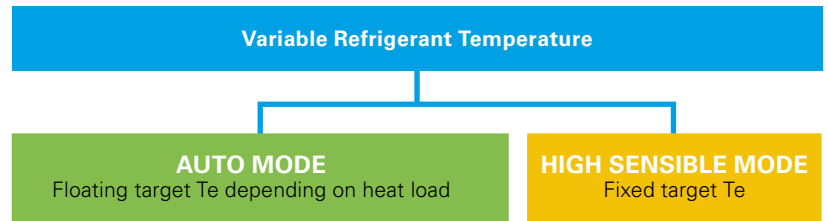

Selecting VRT enables operation to be optimised for either energy efficiency or rapid cooling.

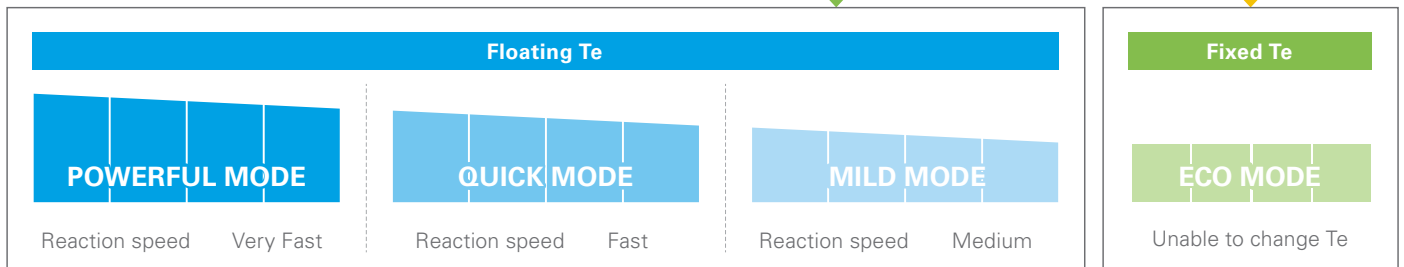

- » Can boost capacity above 100% if needed.  
The refrigerant temperature can go lower in cooling than the set minimum.
- » Gives priority to very fast reaction speed.  
The refrigerant temperature goes down fast to keep the room setpoint stable.

- » Gives priority to fast reaction speed.  
The refrigerant temperature goes down fast to keep the room setpoint stable.

- » Gives priority to efficiency.  
The refrigerant temperature goes down gradually giving priority to the efficiency of the system instead of the reaction speed.



Up to 28% improved seasonal cooling efficiency vs. VRV III.\*

\* In markets where cooling is dominant. VRT functionality for heating operation improves the efficiency as well.

# Daikin VRV

## Setting the Standards, Again (cont.)

### Extended Operation Range — Heating operation down to -22° F\* outdoor temperature and cooling operation down to -4° F\*

Daikin VRV systems can provide heating inside the building even when the outside air temperature is as low as -22° F\* as standard. This enables enhanced application flexibility and use of the system in colder regions.

\*varies based on outdoor unit type

#### Temperature Limits

##### VRV Air-Cooled

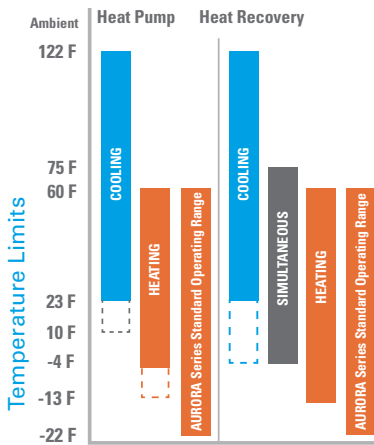

- ▬ VIA technical cooling function
- ▬ VIA extended capacity tables
- Cooling operation for VRV IV Heat Pump single module systems (RXY072/96/120/144/168T) can be extended down to 10° F, from the standard limitation of 23° F under defined conditions.
- Contact your local Daikin manufacturer's representative or distributor for details.

##### VRV T-Series Water-Cooled

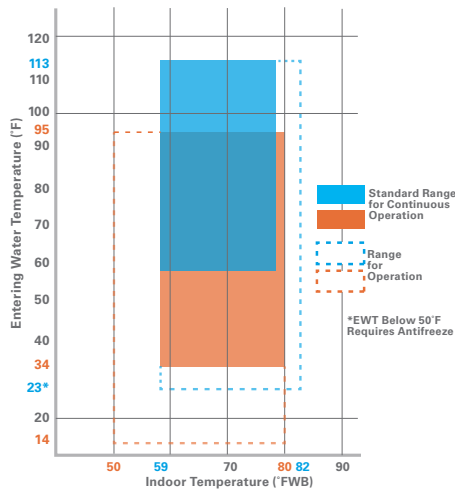

\* Limited to 27° F (for the PC series)

### Piping flexibility — More options for installation location

Daikin VRV provides very flexible piping possibilities. These generous allowances outlined in the figure facilitate an extensive variety of system designs.

- » 100 ft. maximum vertical difference between indoor units provides greater flexibility for riser type piping layouts.
- » Allows for up to 12 floors to be served from a single VRV System
- » Ideal for mid- to high-rise chiller or WSHP replacement projects

#### Refrigerant Piping Limitations

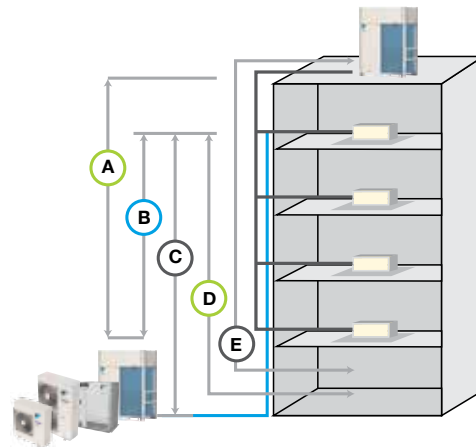

PIPING LIMITATIONS Liquid Line Max (ft)	AIR-COOLED				WATER-COOLED		
	VRV-IV Heat Pump	VRV-IV/X Heat Recovery	VRV AURORA™ Low Ambient	VRV IV-S (3 Ton)	VRV IV-S (4 & 5 Ton)	VRV IV-W PC-Series	VRV T-Series
A Vertical Drop	164 (295) <sup>1</sup>	164 (295) <sup>1</sup>	164 (295) <sup>1</sup>	98	98	164	164
B Between IDU	100	100 (49) <sup>3</sup>	100 (49) <sup>3</sup>	33	49	49	98
C Vertical Rise	130 (295) <sup>1</sup>	130 (195) <sup>1</sup>	130 (295) <sup>1</sup>	98	98	130	130
D From 1st Joint	130 (295) <sup>2</sup>	130 (295) <sup>2</sup>	130 (295) <sup>2</sup>	130	130	130	130 (295) <sup>2</sup>
E Linear Length	540	540	540	164	230	390	540
Total Network	3280	3280	1640	820	984	980	980

<sup>1</sup> Setting adjustment on condensing unit required.

<sup>2</sup> Application rules apply. Refer to Installation Manual for further details.

<sup>3</sup> Possible refrigerant noise can be mitigated (via setting adjustments on ODU) when linear length exceeds 390 ft.



## Improved connection ratio flexibility

To properly match outdoor units with indoor units, VRV system designers calculate the connection ratio.

If a system has more combined indoor unit capacity index than combined outdoor unit capacity index, the result is a combination ratio that is greater than 100%. If the outdoor unit combined capacity index is higher than the index for indoor units, the combination ratio is less than 100%.

Most Variable refrigerant flow system systems do not allow the combination ratio to be more than 130%. However, due to the advanced design of the Daikin VRV IV system, the connection ratio is in most cases allowed to be up to 200%.

This generous connection ratio range enables increased flexibility when a VRV system is designed.

Connection ratio 50%–200%\*

$$\text{Connection ratio} = \frac{\text{Total capacity index of the indoor units}}{\text{Total capacity index of the outdoor units}}$$

### Conditions of VRV indoor unit connection capacity

APPLICABLE VRV INDOOR UNITS	FXDQ, FXSQ_T, FXMQ_P, FXAQ		OTHER VRV INDOOR UNIT MODELS	FXFQ07T, FXFQ09T, FXSQ05T, FXZQ05T
Single outdoor units			200%	180%
Double outdoor units		200%	160%	160%
Triple outdoor units			130%	130%

\* Connection ratio limitations vary based on outdoor unit and indoor unit models



## Daikin VRV

# Setting the Standards, Again (cont.)

### Advantages of 3-pipe technology

Daikin 3-pipe technology used in heat recovery systems has dedicated refrigerant pipes for suction gas, liquid and discharge gas. The dedicated refrigerant pipes provide smooth and efficient refrigerant flow during all main modes of operation and aid with the heating performance of the system

In a 2-pipe heat recovery system, where the gas and liquid travel as a mixture in the refrigerant pipes, the condensing temperature needs to be higher in order to separate the mixed gas and refrigerant. The higher condensing temperature that is needed means that the compressor has to work harder. In addition, the disturbed refrigerant flow in large pipes on 2-pipe system results in extra pressure drop which can negatively impact the system capacity and efficiency.

### Branch selector boxes for ultimate flexibility

Providing flexibility and minimizing mechanical and electrical installation costs, Daikin's branch selector boxes are ideal for spaces that require individual heating and cooling control.

- » Extended range of product offerings with 1, 4, 6, 8, 10 and 12 port options
- » No drain or condensate consideration required
- » Unlimited number of unused ports per box or system
- » Reduced electrical and mechanical installation costs
- » Ultimate flexibility — choose multi-port or single-port styles to customize your design
- » Up to 72% reduction in footprint, as compared to previous generation models
- » Up to 17% lower sound levels compared to current VRV III models
- » Up to 65% reduction in weight, as compared to previous generation models



## New efficient technology from Daikin

### Inverter board cooled by refrigerant circuit

Minimum influence on electronics from ambient temperature.

Section of the coil in the unit is permanently set as condenser for cooling of the inverter board.

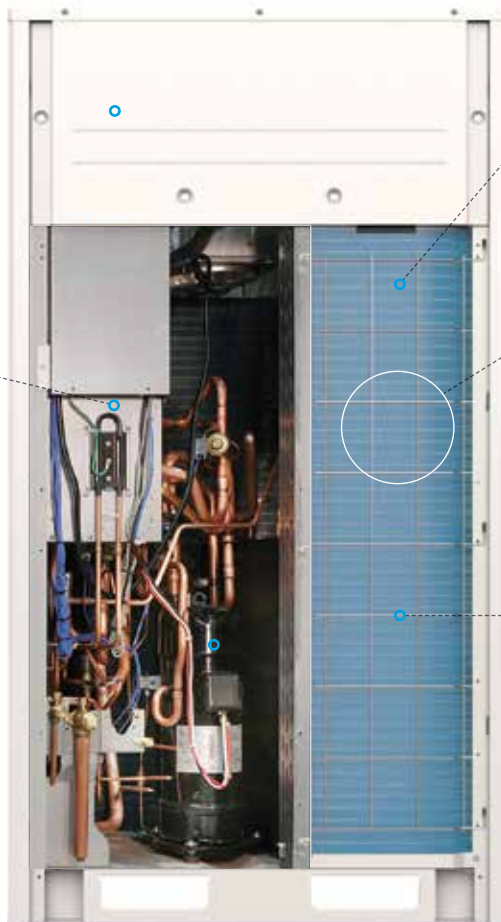
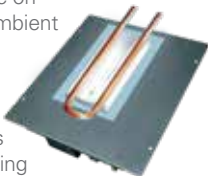

### 7mm Coil — 3 Row

Improved heat exchanger efficiency



### Corrosion protected coil

Daikin VRV comes as standard with a corrosion protected coil — 1000 hr of salt fog testing according to ASTM B117.

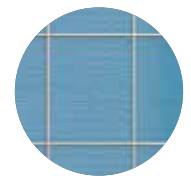

### 4-sided heat exchanger coil

50% more heat exchanger surface than VRV III — more capacity and higher efficiencies from the same footprint

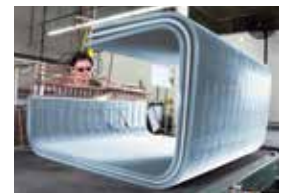

### Inverter board cooled by refrigerant circuit

An inverter Printed Circuit Board (PCB) cooled with the liquid refrigerant circuit increases allows more airflow to the

### 4-Sided heat exchanger coil for efficiency

A 4-sided condenser with up to 3 coil rows utilizing 7 mm tubing means even though the VRV IV has similar footprint as the

### Advanced compressor technology

Daikin J Type Inverter Scroll Compressor has a 50% thinner and a 20% higher scroll blade than the previous generation, which is realized by adapting a newly developed material. This technology increases compression volume by 50%. With the

VRV IV cooling coil to increase efficiency and also minimizes any influence on the inverter board from ambient temperatures.

VRV III, the efficiency is increased while the refrigerant charge is less in most models.

new J Type Compressor and utilizing all inverter compressors, the Maximum Overload Protection (MOP) is reduced by up to 29% compared to VRV III.

50% thinner blade

50% more compression volume

20% higher blade

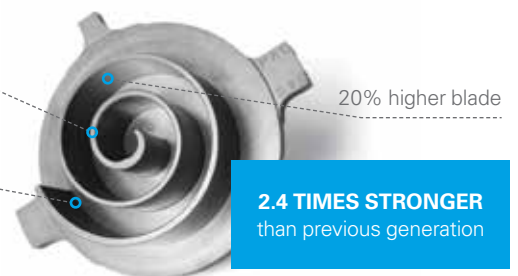

**2.4 TIMES STRONGER**  
than previous generation

## Daikin VRV

# Setting the Standards, Again (cont.)

## Outdoor unit sequencing technology

### Automatic sequencing operation

During start-up, Daikin VRV IV unit sequencing operation will be automatically enabled to ensure balanced operation of each outdoor unit to improve longevity of equipment and stable operation.

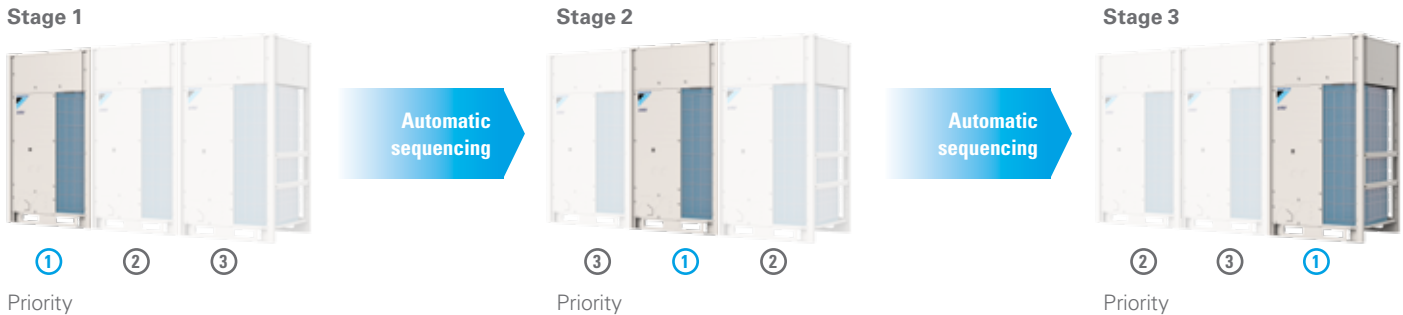

## Double backup operation functions responding resiliently to various unexpected situations

### Double backup operation functions

Daikin VRV IV system boasts double backup operation functions, which can secure the use of air conditioners in this area to the greatest extent by emergently enabling double backup operation functions even if failure occurs in a set of air conditioning equipment. In the event of a failure, emergency operation can be conveniently enabled to allow the remaining system to operate in a limited fashion.

#### Unit backup operation function

If malfunction occurs in an outdoor unit...

Emergency operation can be conveniently set and enabled by the remote controller for indoor unit (for systems composed of two or more outdoor units).



#### Compressor backup operation function

If malfunction occurs in a compressor...

Emergency operation can be easily set and enabled by the outdoor unit.



With the VRV IV heat pump and heat recovery systems, the Daikin brand is one of the most extensive lines of heating and cooling systems in North America.

## Daikin VRV

### Setting the Standards, Again (cont.)

#### VRV outdoor units assembled in the U.S.A.

The VRV IV is the first variable refrigerant flow system to be assembled in North America. With a state of the art production line, local / in house preparation, tooling, processing and construction of heat exchangers, refrigerant

cycle assemblies, sheet metal parts, electrical box, etc., we can react quickly to changes in the market-place and truly optimize the product for the North American market.

- » Extensive local inventory and short lead times.
- » Typically, 98% of replacement parts can be shipped in approximately 48 hours.



## VRV system configuration and commissioning

- » The VRV configurator is an advanced software solution that allows for easy system configuration and commissioning.
- » Less time is required on the roof configuring the outdoor unit.
- » Multiple systems at different sites can be managed in exactly the same way, thus offering simplified commissioning for key accounts.
- » Initial settings on the outdoor unit can be easily retrieved.



Simplified commissioning

Retrieve initial system settings



### Outstanding 10-Year Parts and Compressor Warranties\*



Outstanding commercial warranty\* with 10-Year Replacement Compressor Warranty and 10-Year Parts Warranty as standard ensures our confidence in our new VRV IV.

\* Complete warranty details available from your local Daikin manufacturer's representative or distributor or online at [www.daikincomfort.com](http://www.daikincomfort.com) or [www.daikinac.com](http://www.daikinac.com).

## Daikin VRV

# What does a VRV installation mean to you?

### Consulting engineers

Daikin's VRV IV technology maximizes flexibility and leads the way in customization to match individual building requirements in comfort and energy — all designed to reduce the total life cycle costs.

- » Maximum flexibility to meet customer requirements
- » Advanced software tools assist with system design

### Building owners

VRV IV is the ultimate in customized comfort and intelligent control tailored to your individual needs and used to maximize energy efficiency.

- » Optimized life cycle cost
- » No more cold droughts with variable refrigerant temperature
- » Single point of contact for the design of your climate system
- » Integrated system, combining air conditioning, heating, ventilation, etc., enables optimized system function
- » Multiple systems can be managed in exactly the same way for key accounts
- » Dedicated after-sales service to ensure fast on-site support

See how you can profit from Daikin's flexible and efficient product range.

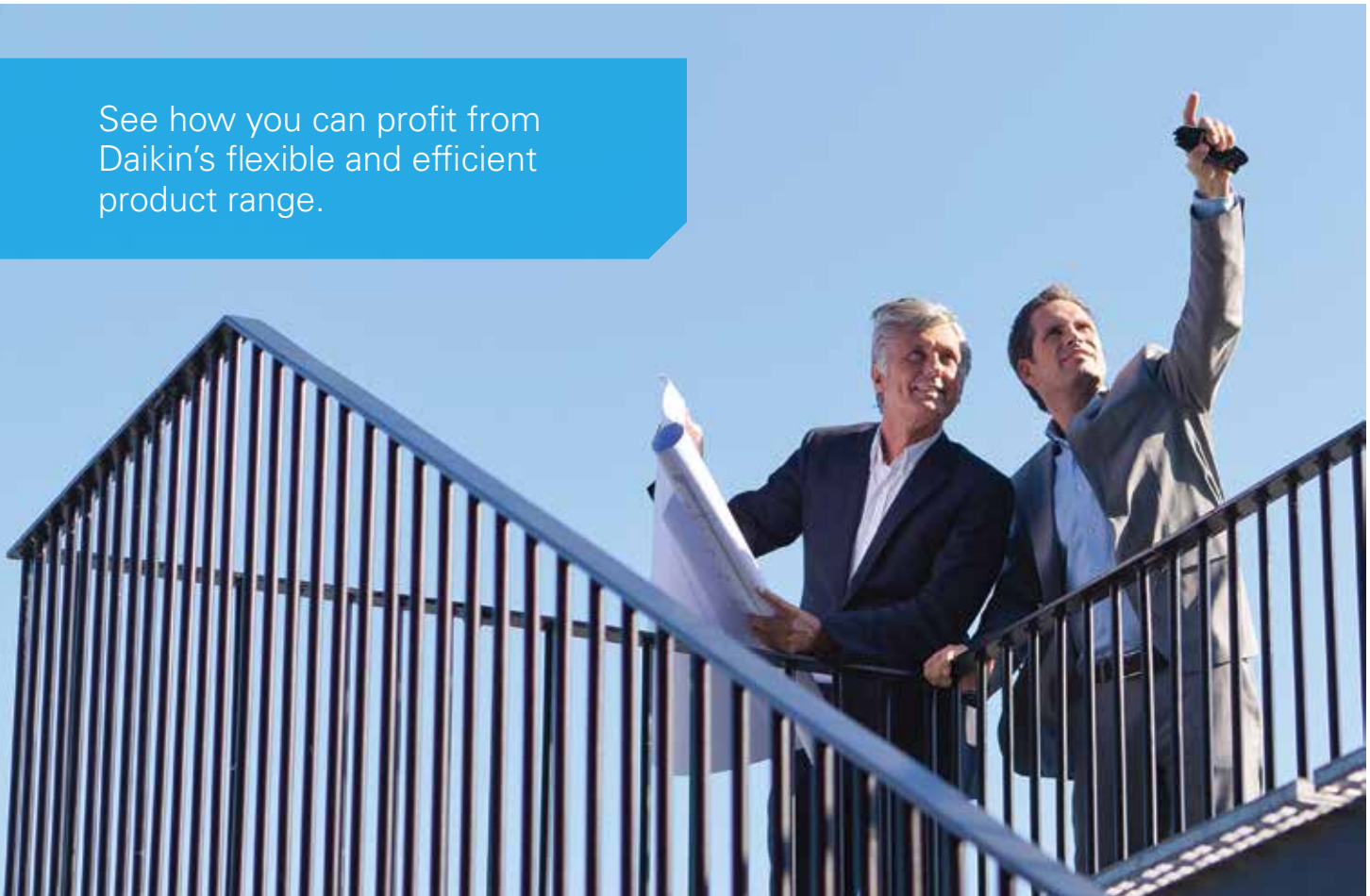



### Installers

Daikin VRV IV sets the standard with state-of-the-art technology and time-saving commissioning and servicing.

- » Simplified and time-saving commissioning with VRV configurator
- » Unique range of single and multi Branch Selector boxes reduce installation time compared to previous generation
- » Wide range of outdoor units (up to 38 Tons for heat recovery)
- » One supplier equals one point of contact
- » Maximum flexibility to meet customer requirements
- » Customized training to maximize expertise

### Architects

- » Indoor units with a sleek and sophisticated design
- » Space efficient outdoor units
- » Low sound levels for both indoor and outdoor units
- » Wide range of indoor units to allow installation in most environments



## Daikin VRV

# Vertical Market Applications



### VRV for offices and banks

#### Our office solution offers:

- » Increased occupant productivity with individual zone control, low sound levels & tight temperature control
- » Optimized energy efficiency
- » Simple maintenance — low operational cost
- » Modular system allowing cost effective out-of-hours operation
- » Integrated ventilation solutions allowing high indoor air quality
- » Complete Daikin Building Management System for office building management with Intelligent Touch Manager
- » Remote monitoring with email alerts
- » Self-cleaning filters yielding operational and maintenance cost savings
- » Intelligent sensors on Round Fow cassette, suspended cassette (optional), and VISTA 2x2 cassette (optional) maximize efficiency using innovative occupancy sensing features.

### VRV for hotels

#### Our hotel solution offers:

- » Energy efficient systems capable of simultaneous heating and cooling.
- » Ultra-quiet guest room solutions discrete and simple to control.
- » Flexible installation options lowering installation complexity, costs and space requirements than most traditional HVAC systems
- » Inverter technology creating the perfect guest room environment by regulating temperature swings and humidity
- » Centralized control with the iTouch Manager improving owner / management operational capabilities
- » Seamless integration & compatibility with industry acclaimed INNCOM systems delivering combined benefits in guest operations and experience for both guests and management team



Heating and cooling



Ventilation



Intelligent control system



## VRV for retail and restaurants

Our retail solutions offer:

- » Scalable project opportunities with modular design
- » Individual zone control for advanced zoning capabilities
- » Enhanced efficiency in retail chain operations and energy usage from Daikin's complete Building Management System with Intelligent Touch Manager
- » Centralized building control & autonomy from VRV remote commissioning and management capability
- » 10-Years Parts and Compressor Warranty\*



## VRV for schools

Our school solution offers:

- » Flexible, scalable total HVAC solution for school classrooms, common areas and administrative offices
- » Over 12,000 Daikin VRV systems in schools in North America
- » Quiet operating sound levels as low as 28 dB(A)
- » Minimal occupant air temperature variations
- » Advanced zoning capabilities with user-friendly and intuitive controls
- » Modular in design accommodating unique school and classroom spaces
- » Self-cleaning filter option for Round Flow cassette simplifies maintenance process and increases operational efficiency
- » Combined benefits of energy and operations efficiency for both school administrators & maintenance staff
- » 10-Year Parts and Compressor Warranty\*

\* Complete warranty details available from your local Daikin manufacturer's representative or distributor or online at [www.daikincomfort.com](http://www.daikincomfort.com) or [www.daikinac.com](http://www.daikinac.com).





# Product Portfolio

## Outdoor Units

### VRV IV X

#### VRV IV X Heat Recovery

Industry's first 3-phase variable refrigerant flow system to integrate with communicating gas furnaces

- » Equipped with Daikin's patented inverter based vapor-injection compressor to provide high heating capacities down to -13°F WB
- » Enhanced design flexibility by allowing for phased installations with predefined pipe sizes and design rules
- » New service window provides ease of access to the multi-functional display without removing the main electrical panel. The built-in multifunctional display is utilized for commissioning and maintenance and quickly converts to digital gauges to provide refrigerant pressure and temperatures.



### VRV

#### VRV AURORA™ Heat Recovery & Heat Pump

- » Variable refrigerant flow system Industry's first air-cooled system that delivers heating down to -22°F (-30°C) as standard
- » Hot gas base pan circuit allows installation without an additional drain pan heater
- » Designed to provide continuous heating during defrost and oil return<sup>1</sup>
- » Engineered with Daikin vapor injection compressor for optimized part load efficiencies



### VRV IV

#### Heat Recovery

- » Fully integrated solution with heat recovery offers high efficiencies with IEER values up to 29.3
- » Total comfort solution for heating, cooling, ventilation, and controls
- » Outstanding warranty\* with 10-Year Compressor and Parts Limited Warranty as standard
- » Perfect personal comfort for guests / tenants via simultaneous cooling and heating
- » Incorporates VRV IV standards and technologies such as variable refrigerant temperature and all inverter compressors
- » Unique range of single and multi-port branch selector boxes
- » Heating function down to -13°F ambient air temperature
- » Daikin VRV IV is the first variable refrigerant flow system to be assembled in North America.



### VRV IV

#### Heat Pump

- » Total comfort solution for heating, cooling, ventilation and controls
- » Energy efficiency values (IEER) up to 28.0
- » Incorporates VRV IV standards and technologies such as variable refrigerant temperature and all inverter compressors
- » Best-in-class warranty\* with 10 year compressor and parts limited warranty as standard
- » Daikin VRV IV is the first variable refrigerant flow system to be assembled in North America.



### VRV IV S-series

#### Air-Cooled

VRV IV-S systems are equipped with built-in intelligence which provide independent zoning control with maximum flexibility and energy savings. With the ability to connect up to ten indoor units to one outdoor unit, the space-saving VRV IV-S system is ideal for most light commercial and residential applications.

- » Available in 3, 4 and 5 ton modules
- » Increase in efficiency up to 18 SEER & 10.5+ HSPF
- » Year round comfort and energy savings delivered by VRT technology
- » Broader diversity with ability to connect up to 9 indoor units
- » Space saving design with under 39"\*\*\* height. Over 25% smaller as compared to VRV III-S
- » Easier to install with over 39% weight reduction vs VRV III-S
- » Low sound levels for comfort
- » Higher reliability with Daikin's swing compressor
- » Dependable operation in extreme ambient conditions up to 122°F
- » Added safety and peace of mind with optional auto changeover to auxiliary heat
- » Backed by a best in class 10-Year Parts Limited Warranty\*



### VRV

#### VRV T-Series Water-Cooled Condensing Unit Heat Pump/Heat Recovery

- » Flexible System design with increased diversity up to 150%<sup>†</sup>
- » Can be applied to both geothermal and boiler/tower applications as standard with condenser water inlet temperature as low as 14°F<sup>†</sup> in heating and 23°F<sup>†</sup> in cooling is possible
- » Triple-stack capable to deliver up to 36 tons in just under 11.5 feet ceiling height thanks to the compact design
- » Engineered with heat rejection cancellation technology<sup>†</sup> to eliminate mechanical room conditioning requirements
- » 2-9V variable water flow control logic<sup>†</sup> as standard to increase waterside system operational efficiencies
- » Drop-down switch box for easy service to key components
- » Field selectable top or front refrigerant connections for flexible and easy installation



<sup>1</sup> Multi module heat recovery systems only for continuous heating during defrost

<sup>†</sup> Conditions/rules apply. Refer to Installation and Engineering Manual for further details.

\* Complete warranty details available from your local Daikin manufacturer's representative or distributor or online at [www.daikincomfort.com](http://www.daikincomfort.com) or [www.daikinac.com](http://www.daikinac.com).

\*\* Varies based on condensing unit model selected



# Product Portfolio (cont.)

## Indoor Units

PRODUCT PORTFOLIO

TYPE	MODEL	FEATURES	PRODUCT NAME
Ducted	HSP DC Concealed Ducted Unit	<ul style="list-style-type: none"> <li>» Energy efficient due to the DC fan motor</li> <li>» Ideal to use together with the optional Daikin Zoning Kit, DZK</li> <li>» Enhanced indoor air quality and LEED ready with MERV 13 filter options</li> <li>» Flexible ductwork design with ESP capabilities up to 0.8" In. Wg</li> <li>» Installation flexibility with a low profile, compact design at less than 12" in height</li> </ul>	FXMQ_PBVJU 
	MSP Concealed Ducted Unit	<ul style="list-style-type: none"> <li>» Powerful static pressure up to 0.6" In. Wg</li> <li>» Low profile height of only 9-11/16"</li> <li>» Auto fan speed control optimizes energy use, occupant comfort, and sound levels</li> <li>» Factory shipped for rear air inlet – field convertible to bottom air inlet</li> <li>» Integral condensate pump with more than 25" of lift</li> </ul>	FXSQ_TAVJU 
	LSP Slim Concealed Ducted Unit	<ul style="list-style-type: none"> <li>» Slim height, at only 7- 7/8"</li> <li>» Washable filter included</li> <li>» Low sound level</li> <li>» Factory shipped for rear air inlet —field convertible to bottom air inlet</li> <li>» Condensate pump with vertical lift of up to 21-3/8" included as standard</li> </ul>	FXDQ_MVJU 
	Multi-Position Air Handling Unit	<ul style="list-style-type: none"> <li>» Ideal replacement for fan coils, geothermal heat pumps or traditional splits systems</li> <li>» Upflow and horizontal right installation is permitted</li> <li>» ECM fan motor provides energy efficiency</li> <li>» Wide line up of electric heat (field installed) options from 3kW to 20kW</li> </ul>	FXTQ_TAVJU 
	HSP High Capacity Concealed Ducted Unit	<ul style="list-style-type: none"> <li>» Design flexibility with a capacity range up to 96 MBH</li> <li>» Improved ductwork and filtration flexibility with high CFM and ESP capabilities</li> <li>» Low profile design of less than 19" high to reduce required installation space</li> <li>» Ideal for Hotels, Schools, Retail</li> </ul>	FXMQ_MVJU 
	Concealed Floor-Standing Unit	<ul style="list-style-type: none"> <li>» Ideal for installation beneath a window</li> <li>» Requires minimal installation space</li> <li>» Fitted with a washable long-life filter</li> <li>» Space-saving unit can be freestanding or wall-mounted</li> </ul>	FXNQ_MVJU9 
Duct-Free	Round Flow Sensing Cassette	 <ul style="list-style-type: none"> <li>» True 360° Airflow and three room sensors enables optimized occupant comfort</li> <li>» Energy efficient with DC fan motor and auto-logic that adjusts fan speed</li> <li>» Optional self-cleaning filter panel to further increase efficiency and reduce maintenance</li> <li>» Increased indoor air quality with high efficiency filter options and ventilation connection kit</li> <li>» Very flexible with 18 different possible airflow patterns</li> </ul>	FXFQ_TVJU 
	4-Way Ceiling-Suspended Cassette	<ul style="list-style-type: none"> <li>» Very low unit height of under 8"</li> <li>» Optional Sensor Kit enables input from three room sensors</li> <li>» Stylish unit blends easily with any interior</li> <li>» Individual air louver control</li> </ul>	FXUQ_PVJU 
	VISTA™ 2x2 Cassette for V/RV Systems	<ul style="list-style-type: none"> <li>» Fits in a standard 2' x 2' ceiling grid with no overlap of adjacent tiles</li> <li>» Features a low profile decoration panel design measuring only 5/16" deep</li> <li>» Space-saving depth of units requires only 11.75" of ceiling space</li> <li>» Easy-to-clean grille, washable long-life filter</li> <li>» Optional space and presence sensor accessory enhances energy efficiency and occupant comfort</li> </ul>	FXZQ_TAVJU 
	Ceiling-Mounted Cassette (Single flow)	<ul style="list-style-type: none"> <li>» Only 7- 7/8" in height and a width of 18-1/2" making it possible to use this style of indoor unit in the tightest of spaces</li> <li>» The unit is equipped with both horizontal and vertical louvers to optimize the airflow and throw to suite your room design</li> <li>» The indoor unit can be set to 5 predetermined fan speeds which allows for optimum and comfortable airflow</li> <li>» Factory installed condensate pump with a lift capacity of up to 33- 7/8" (measured from the bottom of the unit)</li> </ul>	FXEQ_PVJU 
	Ceiling-Suspended Unit	<ul style="list-style-type: none"> <li>» One of our slimmest indoor units, less than 8"</li> <li>» Wide air discharge outlet distributes a comfortable airflow throughout the entire space</li> <li>» Innovative stream fan technology keeps sound pressure levels low</li> <li>» Smooth flat louver design makes cleaning simple</li> <li>» Long-life filter is standard</li> </ul>	FXHQ_MVJU 
	Wall-Mounted Unit	<ul style="list-style-type: none"> <li>» Auto-swing mechanism ensures efficient air distribution via louvers</li> <li>» Wide air discharge outlet distributes a comfortable airflow throughout the entire space</li> <li>» Horizontal louvers and front panel can be easily removed for cleaning</li> <li>» Drain pipe can be easily hidden from sight</li> <li>» Compact and stylish design</li> </ul>	FXAQ_PVJU 
	Floor-Standing Unit	<ul style="list-style-type: none"> <li>» Ideal for installation beneath a window</li> <li>» Unit requires minimal installation space</li> <li>» Fitted with a washable long-life filter</li> <li>» Remote-control options available</li> <li>» Space-saving unit can be freestanding or wall-mounted</li> </ul>	FXLQ_MVJU9 









	CAPACITY															
	MBH	5.8	7.5	9.5	12	15	18	24	30	36	42	48	54	60	72	96
	TON	0.5	0.6	0.75	1	1.25	1.5	2	2.5	3	3.5	4	4.5	5	6	8
			■	■	■	■	■	■	■			■	■			
	■	■	■	■	■	■	■	■	■			■	■			
		■	■	■		■	■									
				■		■	■	■	■	■	■	■	■	■		
															■	■
		■	■	■		■	■									
		■	■	■		■	■									
		■	■	■		■	■	■	■							
	■	■	■	■	■	■	■									
		■	■	■	■	■	■									
				■			■		■							
		■	■	■		■	■									
		■	■	■		■	■									

# Product Portfolio (cont.)

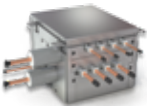
## Accessories

### Branch Selector Boxes

Providing flexibility and minimizing mechanical and electrical installation costs, Daikin's branch selector boxes that are used in Heat Recovery systems, are ideal for spaces that require individual heating and cooling control.

NUMBER OF BRANCHES / MAXIMUM TOTAL CAPACITY INDEX (KBTU/H)							
							
BSQ36TVJ	BSQ60TVJ	BSQ96TVJ	BS4Q54TVJ	BS6Q54TVJ	BS8Q54TVJ	BS10Q54TVJ	BS12Q54TVJ
1/36	1/60	1/96	4/144	6/216	8/290	10/290	12/290

### REFNET

REFNET joints distribute correct flow of refrigerant in every branch of the piping network.



REFNET Joint



REFNET Header

### VRV IV Heat Pump / VRV AURORA™ Heat Pump

OPTIONAL ACCESSORIES		RXYQ72T RXYQ96T RXLQ72T RXLQ96T	RXYQ120T RXYQ144T RXYQ168T RXLQ120	RXYQ192T RXYQ216T RXYQ240T RXYQ264T RXYQ288T	RXYQ312T RXYQ336T RXLQ144T RXLQ192T RXLQ240T	RXYQ360T RXYQ384T RXYQ408T
Distributed piping	REFNET Header	KHRP26M22H (max. 4 branch) KHRP26M33H (max. 8 branch)	KHRP26M22H (max. 4 branch) KHRP26M33H (max. 8 branch) KHRP26M72H (max. 8 branch)	KHRP26M22H (max. 4 branch) KHRP26M33H (max. 8 branch) KHRP26M72H (max. 8 branch) KHRP26M73H (max. 8 branch)		
	REFNET Joint	KHRP26A22T, KHRP26A33T	KHRP26A22T, KHRP26A33T, KHRP26M72TU	KHRP26A22T, KHRP26A33T, KHRP26M72TU, KHRP26M73TU		
Outdoor unit multi connection piping kit		—		BHFP22P100U	BHFP22P151U	

### VRV IV X Heat Recovery / VRV IV Heat Recovery / VRV AURORA™ Heat Recovery

OPTIONAL ACCESSORIES		REYQ72T REYQ96T	RELO72T RELO96T	REYQ120T REYQ144T REYQ168T	RELO120T	REYQ192T REYQ216T REYQ240T REYQ264T REYQ288T REYQ312T REYQ336T	RELO144T RELO192T RELO240T	REYQ360T REYQ384T REYQ408T REYQ432T REYQ456T
		REYQ72X REYQ96X		REYQ120X REYQ144X REYQ168X		REYQ192X REYQ216X REYQ240X REYQ264X REYQ288X REYQ312X REYQ336X		REYQ360X REYQ384X REYQ408X REYQ432X REYQ456X
Distributed piping	REFNET header	KHRP25M33H9 (max. 8 branch)		KHRP25M33H9 (max. 8 branch) KHRP25M72H9 (max. 8 branch)		KHRP25M33H9 (max. 8 branch) KHRP25M72H9 (max. 8 branch) KHRP25M73H9 (max. 8 branch)		
	REFNET joint	KHRP25A22T9 KHRP25A33T9		KHRP25A22T9 KHRP25A33T9 KHRP25M72TU9		KHRP25A22T9 KHRP25A33T9 KHRP25M72TU9 KHRP25M73TU9		
Outdoor unit multi connection piping kit		—		—		BHFP26P100U	BHFP26P151U	

VRV T-Series Water-Cooled Heat Pump / Heat Recovery and VRV-IV-S

UNIT MODEL NUMBER		VRV T-SERIES WATER-COOLED				VRV-IV-S	
		RWEQ96TATJU RWEQ96TAYDU	RWEQ120TATJU RWEQ120TAYDU	RWEQ144TATJU RWEQ144TAYDU	RWEQ192,216,240, 264,288TATJU RWEQ192,216,240, 264,288TAYDU	RWEQ312,336,360TATJU RWEQ312,336,360TAYDU	RXTQ36TAVJ9 RXTQ48TAVJU RXTQ60TAVJU
REFNET Header	Heat Pump	KHRP26M22HR (Max 4 branch) KHRP26M33H9 (Max 8 branch)	KHRP26M22H9 (Max 4 branch), KHRP26M33H9 (Max 8 branch) KHRP26M72H9 (Max 8 branch)	KHRP26M22H9 (Max 4 branch), KHRP26M33H9 (Max 8 branch) KHRP26M72H9 (Max 8 branch), KHRP26M73HU9 (Max 8 branch)		KHRP26M22H9 (Max. 4 branch) KHRP26M33H9 (Max. 8 branch)	
	Heat Recovery	KHRP26M33H9 (Max 8 branch)	KHRP25M33H9 (Max 8 branch) KHRP25M72H9 (Max 8 branch)	KHRP25M33H9 (Max 8 branch), KHRP25M72H9 (Max 8 branch) KHRP25M73HU9 (Max 8 branch)		---	
REFNET Joint	Heat Pump	KHRP26A22T9, KHRP26A33T9	KHRP26A22T9, KHRP26A33T9, KHRP26M72TU9	KHRP26A22T9, KHRP26A33T9, KHRP26A72UT9, KHRP26M73TU9		KHRP26A22T9	
	Heat Recovery	KHRP25A22T9, KHRP25A33T9	KHRP25A22T9, KHRP25A33T9, KHRP25M72TU9	KHRP25A22T9, KHRP25A33T9, KHRP25A72TU9, KHRP25M73TU9		---	
Outdoor Unit Multi Piping Connection Kit	Heat Pump	---	---	BHFP22T84U	BHFP22T126U	---	
	Heat Recovery	---	---	BHFP26T84U	BHFP26T126U	---	

Hail Guard Kit for VRV IV, IV X, and AURORA™

The optional hail guard kit for VRV 3 ph enables optimal airflow for efficient heat transfer while providing condenser coil protection from hail damage in severe climates. Each hail guard kit, that is field installed, consists of 4 panels (Right, Left, Front and Back).



KIT PART NUMBER	QUANTITY OF KITS PER ODU MODELS				
	R_YQ72T	R_YQ96-168T	R_YQ192T	R_YQ216-336T	R_YQ360-456T
		R_LQ72-120T		R_LQ144-240T	
		R_YQ72-168X		R_YQ192-336X	R_YQ360-456X
VRV4HGS-K1	1		1		
VRV4HGL-K1		1	1	2	3

Snow/Wind Hood Kits

The optional Snow/Wind Hood Kits mount to VRV IV, IV X, and VRV AURORA series units over the heat exchanger coil to protect from snow build-up and wind in cold climates. The Hoods install easily to condensing units using existing screw taps with no modification required. Different kits can be ordered for different job requirements.

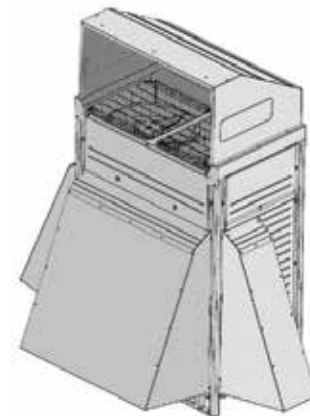

KIT PART NUMBER	CHASSIS SIZE	KIT INCLUSION	
VRV-SHS-FR	Small Chassis	Front Hood	Rear Hood
VRV-SHL-FR	Large Chassis	Front Hood	Rear Hood
VRV-SH-RL	Both Chassis	Right Hood	Left Hood
VRV-SHS-T	Small Chassis	Top Hood	
VRV-SHL-T	Large Chassis	Top Hood	

# Product Portfolio (cont.)

## Accessories (continued)

### DZK (Daikin Zoning Kit)



The optional DZK increases the flexibility of the Daikin VRV and SkyAir systems in both residential and commercial applications by adding a Zoning Box to an indoor unit fan coil, allowing several separate ducts to supply air to different individually controlled zones. The DZK BACnet® Interface module will work with any BACnet/IP compatible Building Management System.

DZK Zoning Box for FXMQ\_PB and FXSQ indoor units











DZK Wired, Wireless, and Wireless Lite thermostat options



### Daikin VRV controls

Optimized for VRV technology, Daikin controls provide highly scalable solutions for all applications and budgets. VRV controls offer solutions to meet your project controls needs from individual zone control with local controllers to centrally controlling the building with Centralized Controllers and/or interfacing with Building Management Systems (BMS) for comfort control in an easily managed and operated system.

PROJECT REQUIREMENTS	DAIKIN VRV CONTROLS							
	 DKN Cloud Wi-Fi Adaptor	 Navigation™ Remote Controller	 Simplified Remote Controller	 intelligent Touch Controller™	 intelligent Touch Manager™	 BACnet® Interface	 LonWorks® Interface	 Modbus® Interface
Individual zone control	■	■	■					
Independent cool and heat setpoints	■	■		■	■			
Individual zone control with weekly programmable scheduling	■	■		■	■			
Basic central point on/off control of all air handling units	■			■	■	■	■	■
Advanced multi-zone control of small to medium size projects				■	■	■	■	■
Advanced multi-zone control of large commercial projects				■	■	■	■	
Advanced multi-zone control with scheduling logic and calendar				■	■			
Automatic cooling/heating changeover for heat pump systems				■	■			
Single input batch shutdown of all connected air handlers				■	■	■	■	■
Web browser control and monitoring via Intranet and Internet				■	■	■	■	■
E-mail notification of system alarms and equipment malfunctions				■	■	■	■	■
Multiple tenant power billing for shared condenser applications				■	■			
Temperature set-point range restrictions				■	■	■	■	■
Graphical user interface with floor plan layout					■	■	■	■
Start/stop control of ancillary building systems*				■	■	■	■	■
Daikin VRV integration with BACnet based automation systems					■	■		
Daikin VRV integration with LonWorks based automation systems							■	
Daikin VRV integration with Modbus based automation systems								■
Wi-Fi option remote access through smartphone app	■							

\* Requires one or more DEC102A51-US2 Digital Input/Output units or WAGO® IO module (for use with iTM only).

■ Native application or feature for this device. ■ Dependent upon capabilities of the third party energy management system





The configurable display and operation buttons on the Navigation™ Remote Controller will provide as much or as little control as the installed VRV system requires.



# Product Portfolio (cont.)

## Accessories (continued)

### Network solutions

TYPE		iTC™	iTM™	LonWorks®	BACnet®	ModBus®
						
Screen	Layout screen		■			
	Touch screen	■	■			
Integration	Mini BMS for heating, air conditioning applied systems and refrigeration units (BACnet and WAGO)		■			
	3rd party equipment integration (BACnet and WAGO)		■			
Control	Basic control functions: on/off, set point setting, air flow settings, operation mode	■	■	■	■	■
	Temperature limitation	■	■			
	Setback		■			
	Automatic changeover	■	■			
	Weekly schedule and special day pattern	■	■			
	Timer extension		■			
	Forced off	■	■	■	■	
	Interlock	■	■			
Monitoring	Basic control functions: ON/OFF status, operation mode, set point temp.	■	■	■	■	■
	Filter status	■	■	■	■	■
	Malfuction code	■	■	■	■	■
	History (operation, malfunction...)	■	■			
	History (Indoor and outdoor unit operation data)		■			
Options	Visualization	■	■			
	PPD (Power Proportional Distribution)	■	■			
	Web access and control	■	Std			
	HTTP option	■				
	BACnet Client		■			
	BACnet Server		■			
	D-Net Service	■	■			
Other	Operation Data		■			
	Maximum number of indoor unit groups	2 x 64	8 x 64	64	4 x 64	16

## Powerful Service Tool with Indoor and Outdoor Unit Operation Data Points

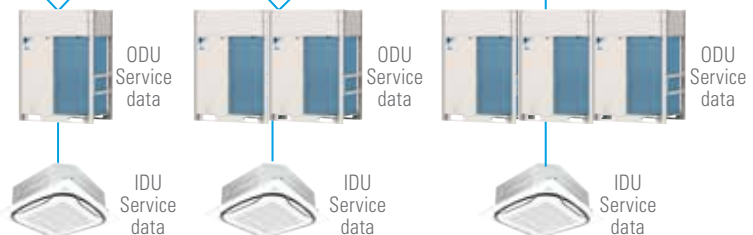



- » When a problem occurs, the BMS integrators and Service Technicians can start troubleshooting immediately before going to the site.
  - » Indoor and outdoor operation data trending\* by BMS can benefit the VRF service process.
- \*BMS programming needed

**Air treatment systems**

Daikin’s Outside Air Processing Unit can combine fresh air treatment and air conditioning, supplied from a single system.

The compact Energy Recovery Ventilator is designed to improve indoor air quality while reducing the overall HVAC system power

consumption. This is achieved by providing fresh outside air and recovering waste heat from exhaust air leaving the conditioned space.

		OUTSIDE AIR PROCESSING UNIT, FXMQ_MFVJU	ENERGY RECOVERY VENTILATOR, VAM-GVJU
			
VRV Refrigerant Piping		Connectable	Not connectable
VRV Control Wiring		Connectable	
High Efficiency Filter (MERV 8 and MERV 13)		Option	Not available
Ventilation System		Air supply	Air supply and Air exhaust
Power Supply		V/ph/Hz	208-230/1/60
Airflow Rate	CFM	635 988 1236	300/300/170 470/470/390 600/600/500 1200/1200/930



Daikin’s air treatment systems — creating a better air quality environment.







# Indoor Units



# Indoor Units

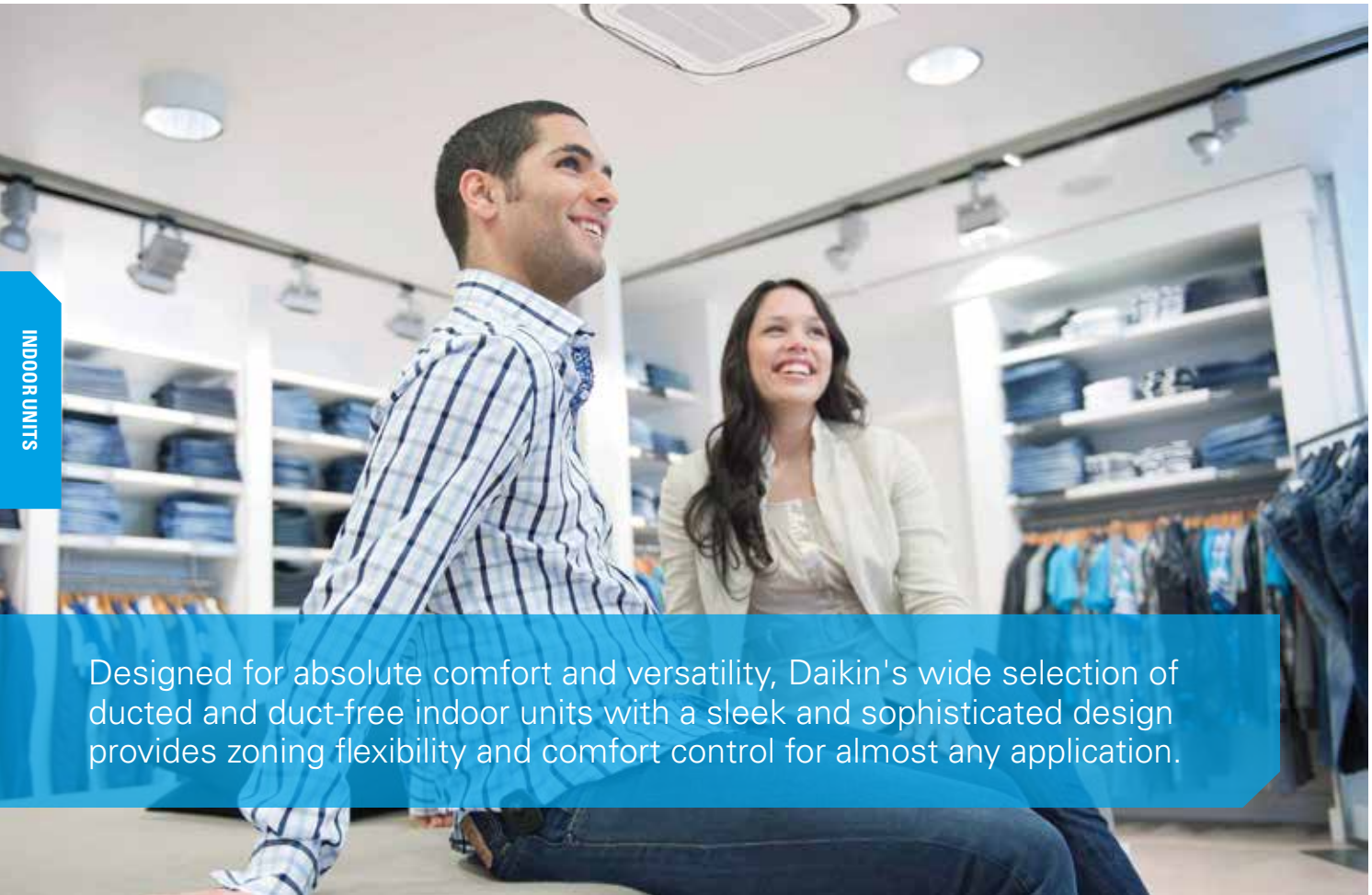

INDOOR UNITS

Designed for absolute comfort and versatility, Daikin's wide selection of ducted and duct-free indoor units with a sleek and sophisticated design provides zoning flexibility and comfort control for almost any application.

As many as 64 separate indoor units can be connected to a refrigerant circuit with a single outdoor unit of up to 38 tons capacity. The Daikin VRV indoor unit range is one of the widest on the market, offering no less than 13 stylish and elegant indoor units types in 81 different models — all designed to maximize comfort, minimize operating sound and simplify installation and servicing.

Indoor unit models include Round Flow ceiling mounted cassette, ceiling concealed ducted, ceiling suspended, wall mounted and floor standing models.

The Round Flow sensing cassette now includes an optional variable refrigerant flow system industry first self-cleaning filter, which automatically cleans itself daily

(user adjustable), leading to yearly energy savings of up to 50%. Dust from the filter is collected in the unit for easy and quick removal (when indicated) with a standard vacuum cleaner.

Designed to fit rooms of any size and shape, Daikin indoor units are also user friendly, ultra reliable, easy to control and quiet in operation.

INDOOR UNIT TYPE		CAPACITY															
		MBH TONS	5.8 0.5	7.5 0.6	09 0.75	12 1	15 1.25	18 1.5	24 2	30 2.5	36 3	42 3.5	48 4	54 4.5	60 5	72 6	96 8
DUCTED	FXMQ_PBVJU HSP DC Concealed Ducted Unit			▲	▲	▲	▲	▲	▲	▲	▲	▲	▲				
	FXSQ_TAVJU MSP Concealed Ducted Unit		▲	▲	▲	▲	▲	▲	▲	▲	▲	▲	▲	▲			
	FXDQ_MVJU LSP Slim Concealed Ducted Unit			▲	▲	▲		▲	▲								
	FXTQ_TAVJU Multi-Position Air Handling Unit (Upflow, Downflow, Horizontal Left and Horizontal Right)					▲		▲	▲	▲	▲	▲	▲	▲	▲		
	FXMQ_MVJU HSP High Capacity Concealed Ducted Unit															▲	▲
	FXNQ_MVJU9 Concealed Floor-Standing Unit			▲	▲	▲		▲	▲								
DUCT-FREE	FXFQ_TVJU Round Flow Sensing Cassette, Ceiling Mounted	 <b>ROUND FLOW</b>		▲	▲	▲	▲	▲	▲	▲	▲	▲	▲				
	FXUQ_PVJU 4-Way Blow Ceiling-Suspended Cassette							▲	▲	▲	▲						
	FXZQ_TAVJU VISTA™ 2x2 Cassette for VRV		▲	▲	▲	▲	▲	▲									
	FXEQ_PVJU Ceiling-Mounted Cassette (Single Flow)			▲	▲	▲	▲	▲	▲								
	FXHQ_MVJU Ceiling-Suspended Unit					▲			▲		▲						
	FXAQ_PVJU Wall-Mounted Unit			▲	▲	▲		▲	▲								
	FXLQ_MVJU9 Floor-Standing Unit			▲	▲	▲		▲	▲								

▲ Comfort cooling/heating    Condensate pump standard    Outside air connection possible

# Indoor Units Overview

## What are your choices?

### FXMQ\_PBVJU

#### HSP DC Concealed Ducted Unit

Ceiling mounted DC-Ducted unit — ideal for small to large spaces in need of a concealed air-conditioning system.



### FXMQ\_MVJU

#### HSP High Capacity Concealed Ducted

Ideal unit for larger open space floor plans usually found in offices, retails, hotels or education facilities.



### FXSQ\_TAVJU

#### MSP Concealed Ducted

Ducted unit with compact design and powerful static pressure capabilities.



### FXTQ\_TAVJU

#### Multi-Position Air Handling Unit

Vertical air handling unit ideal for both residential and light commercial applications.



It has upflow, downflow, horizontal left and horizontal right possibilities.



### FXDQ\_MVJU

#### LSP Slim Concealed Ducted Unit

Slim duct built-in concealed unit with low profile and low sound level.



### FXNQ\_MVJU9

#### Concealed Floor-Standing Unit

Floor-standing unit that can easily be installed along a perimeter wall — or concealed



### FXLQ\_MVJU9

#### Floor-Standing Unit

Great way to save space. The floor-standing units can easily be installed along a perimeter wall.



**FXFQ\_TVJU**

Round Flow Sensing Cassette, Ceiling Mounted

Ideal for open plan applications such as classrooms and offices where adaptive comfort control is preferred. Provides excellent comfort level, energy efficiency, and flexibility due to advanced control functions.



**FXZQ\_TAVJU**

VISTA™ 2x2 Cassette for VRV

2'x2' 4-way Cassette best for open plan applications such as classrooms, offices and retail.



**FXUQ\_PVJU**

4-Way Blow Ceiling-Suspended Cassette

Perfect solution for rooms without a false ceiling, or minimal space above a false ceiling, where adaptive comfort control is preferred.



**FXEQ\_PVJU**

Ceiling-Mounted Cassette (Single Flow)

Slim and compact design for installation flexibility. For hotel rooms, offices and residential.



**FXAQ\_PVJU**

Wall-Mounted Unit

Unit ideal for cooling or heating smaller zones such as stores, offices and restaurants. Compact and stylish design.



**FXHQ\_MVJU**

Ceiling-Suspended Unit

Ceiling-suspended with slim and elegant design.





Condensate Pump as Standard



Outside Air Integration Possible

Powerful, Concealed, Flexible

The ceiling mounted HSP DC concealed ducted unit is ideal for small to large spaces in need of a concealed air-conditioning system. It is extremely powerful and the compact design allows it to be completely concealed. This makes it perfect for retail, classrooms, offices, banks, restaurants, shops and hotels common areas.

Features and Benefits

- » Capacity range up to 54 MBH.
- » Energy efficient due to the DC fan motor
- » Ideal to use together with the optional Daikin Zoning Kit, DZK
- » Configurable auxiliary heater control logic
- » Enhanced indoor air quality and LEED ready with MERV 13 filter options
- » Ease of installation with auto adjusting airflow at commissioning based on external static pressure
- » Flexible ductwork design with ESP capabilities up to 0.8" W.G.
- » Installation flexibility with a low profile, compact design at less than 12" in height
- » Easy maintenance with complete service access from below
- » Option to permanently turn off the condensate pump via field settings



BRC1E73 (option)



AZAI6WSCDKA (option)



BRC2A71 (option)



BRC4C82 (option)

Auto Adjust External Static Pressure

- » After installation, it is possible that the actual duct resistance is lower than expected at the time of designing. As a consequence, the air-flow will be too high.
- » With the automatic air-flow adjustment function the unit can adapt its fan speed to a lower curve, so the air-flow decreases.
- » The air-flow will always be within 10% of the rated air-flow because of the amount of possible fan curves (more than 8 fan curves available per model).
- » Alternatively the installer can manually select a fan curve with the wired remote control.

Applications

- » Offices
- » Hotels
- » Schools
- » Retail

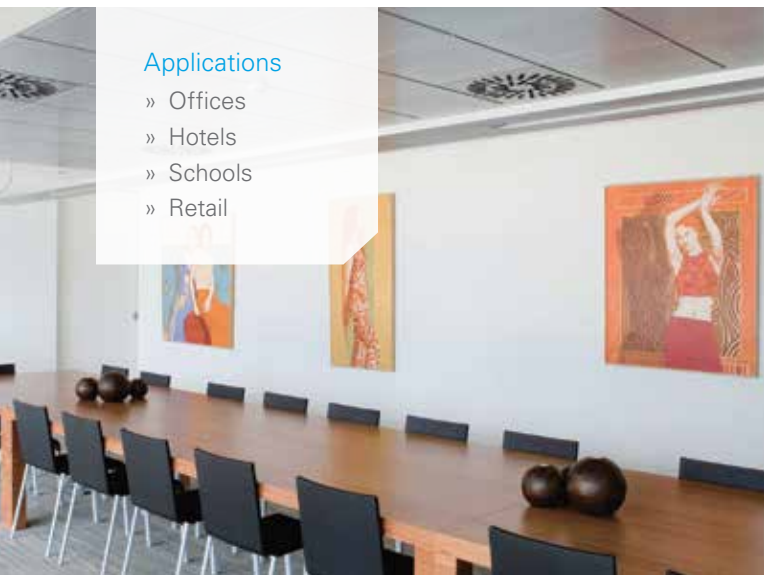

Auto Adjust External Static Pressure

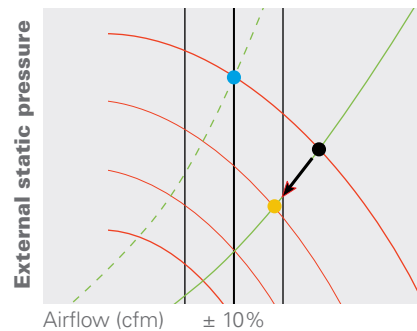

- Fan characteristic curve
- Actual duct resistance curve
- - - Duct resistance curve at the time of designing
- Rated airflow
- Airflow without airflow automatic adjustment
- Actual airflow

FXMQ_PBVJU SPECIFICATIONS		0.6 Ton	0.75 Ton	1.0 Ton	1.25 Ton	1.5 Ton	2.0 Ton	2.5 Ton	3.0 Ton	4.0 Ton	4.5 Ton	
Model Name		FXMQ07PBVJU	FXMQ09PBVJU	FXMQ12PBVJU	FXMQ15PBVJU	FXMQ18PBVJU	FXMQ24PBVJU	FXMQ30PBVJU	FXMQ36PBVJU	FXMQ48PBVJU	FXMQ54PBVJU	
Power Supply	V/ph/Hz	208-230/1/60										
Rated Cooling Capacity	BTU/h	7,500	9,500	12,000	15,000	18,000	24,000	30,000	36,000	48,000	54,000	
Rated Heating Capacity	BTU/h	8,500	10,500	13,500	17,000	20,000	27,000	34,000	40,000	54,000	60,000	
Airflow Rate (H/M/L)	CFM	317/264/229		450/410/388	560/530/500	635/582/529	688/618/565	1,094/953/812	1,130/953/812	1,377/1,165/988	1,624/1,377/1,130	
Height	in.	11-3/16										
Width	in.	21-5/8		27-9/16	39-3/8			55-1/8				
Depth	in.	27-9/16										
Weight	lbs.	55 (25)		62 (28)	80 (36)			102 (46)		104 (47)		
Condensate Pump Lift	in.	18-3/8										
Sound Pressure (H/M/L)	dB(A)	33/31/29		39/37/35	40/38/37	41/39/37	42/40/38	43/41/39		44/42/40	46/45/43	
Condensate Pipe Connection	in. O.D.	1-1/4										
Pipe Connections	Gas	in.					1/2 (Flare)		5/8 (Flare)			
	Liquid	in.					1/4 (Flare)		3/8 (Flare)			
Refrigerant		R-410A										
Refrigerant Control		Electronic Expansion Valve										
Maximum Overcurrent Protective Device	A	15										
Minimum Circuit Amps	A	0.6	1.4	1.5	1.6	1.8	2.8	2.9	3.4			
Protection Devices		Fuse and Fan Driver Overload Protector										
External Finish		Galvanized Steel Plate										
External Static Pressure (H/L)	in. Wg	0.40/0.12				0.80/0.20				0.56/0.20		

**MERV 13 Filter Kit Option contains a MERV 13 filter, adaptor frame and easy to follow installation instructions and can be installed on the following models only:**

Kit Model	Indoor Unit
DACA-FXMQ12131K	FXMQ07-09PBVJU
DACA-FXMQ14131K	FXMQ12PBVJU
DACA-FXMQ30131K	FXMQ15-24PBVJU
DACA-FXMQ48131K	FXMQ30-54PBVJU

**ENTHALPY ECONOMIZER (FIELD APPLIED ACCESSORY)**

Model	Indoor Unit
ECONMQ12P-8-1K (MERV 8 Filter)	FXMQ07-09PBVJU
ECONMQ12P-13-1K (MERV 13 Filter)	
ECONMQ30P-8-1K (MERV 8 Filter)	FXMQ15-24PBVJU
ECONMQ30P-13-1K (MERV 13 Filter)	
ECONMQ48P-8-1K (MERV 8 Filter)	
ECONMQ48P-13-1K (MERV 13 Filter)	FXMQ30-54PBVJU

**FXMQ\_PBVJU ACCESSORIES**

Model Name	FXMQ07PBVJU	FXMQ09PBVJU	FXMQ12PBVJU	FXMQ15PBVJU	FXMQ18PBVJU	FXMQ24PBVJU	FXMQ30PBVJU	FXMQ36PBVJU	FXMQ48PBVJU	FXMQ54PBVJU
Navigation™ Remote Controller*	BRC1E73									
DKN Cloud Wi-Fi Adaptor	AZA16WSCDKA									
Simplified Wired Remote Controller*	BRC2A71									
Wireless Remote Controller	BRC4C82									
Remote Sensor Kit	KRCS01-4B									
Wiring Adaptor PCB (interface with aux/primary heater, humidifier, OA damper/fan)	KRP1C74									
Group Control Adaptor PCB (connects to external BMS)	KRP4A71									

\*Optional face plates available to provide a more intuitive user interface and disable specific functions

**FXMQ\_PBVJU INSTALLATION SPACE**

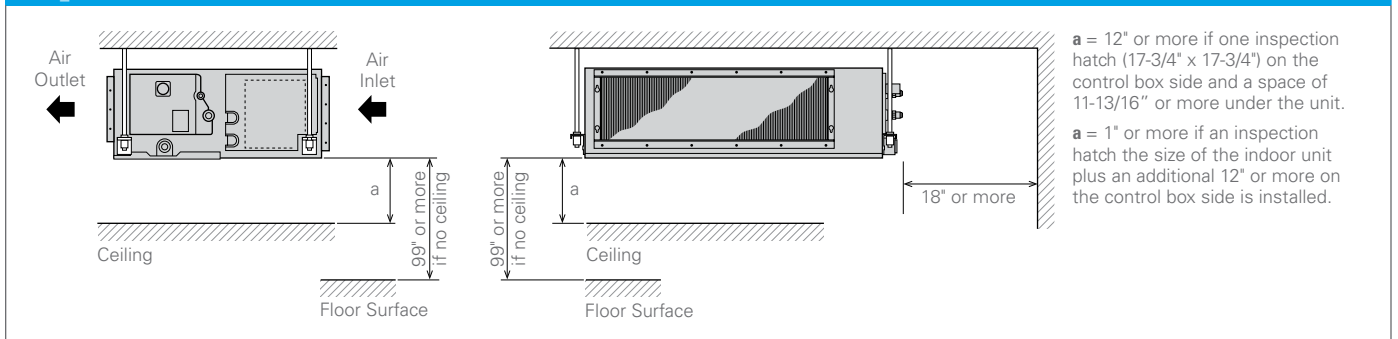

# FXSQ\_TAVJU

## MSP Concealed Ducted Unit



Condensate Pump  
as Standard



Outside Air  
Integration Possible

### Do more with less

The MSP concealed ducted unit is engineered with impressive static pressure capability in a compact, flexible chassis design to give designers a tool to approach even the most cramped air conditioning applications.

### Features and Benefits

- » Powerful static pressure capability, with up to 0.6 in. Wg (150Pa) external static pressure.
- » Ease of installation with auto adjusting airflow at commissioning based on external static pressure.
- » Designed for installation flexibility, with a factory rear-return configuration and field convertible to bottom return.
- » Sound levels as low as 28 dB(A) for quiet operation.
- » Provides a high degree of control for auxiliary heating devices, with independently configurable on/off temperature values.
- » Integral condensate pump with up to 25-5/16" (643mm) of lift from the drain outlet



BRC1E73  
(option)



AZAI6WSCDKA  
(option)



BRC2A71  
(option)



BRC4C82  
(option)

### Flexible Installation

The FXSQ\_TA can easily be converted to a bottom-return configuration to optimize the use of space above the ceiling or bulkhead space.



### Applications

- » Offices
- » Hotel Rooms
- » Multi-family residences
- » Single-family residences
- » Schools





SPECIFICATIONS			0.5 TON	0.6 TON	0.75 TON	1.0 TON	1.25 TON	1.5 TON	
Model Name			FXSQ05TAVJU	FXSQ07TAVJU	FXSQ09TAVJU	FXSQ12TAVJU	FXSQ15TAVJU	FXSQ18TAVJU	
Capacity Index			5.8	7.5	9.5	12	15	18	
Power Supply			208/230VAC, 60Hz, 1 phase						
Nominal Cooling Capacity*1			Btu/h (kW)	5,800 (1.7)	7,500 (2.2)	9,500 (2.8)	12,000 (3.6)	15,000 (4.5)	18,000 (5.6)
Nominal Heating Capacity*2			Btu/h (kW)	6,500 (1.9)	8,500 (2.5)	10,500 (3.1)	13,500 (4.0)	16,500 (5.6)	20,000 (6.3)
Fan	Type	Sirocco fan							
	Motor Output	W	78						
	Air Flow Rate (H/M/L)	CFM	281 / 265 / 230	318 / 265 / 230		335 / 283 / 247	530 / 441 / 371	600 / 512 / 406	
	Drive Type	DC Direct Drive							
	External Static Pressure (Std./Max)	0.2 / 0.6						0.4 / 0.6	
Height			in. 9-11/16						
Width			in. 21-11/16				27-9/16	39-3/8	
Depth			in. 31-1/2						
Weight			lb. 55 (25)				60 (27)	77 (35)	
Condensate Pump Lift			in. 25-5/16 (643)						
Sound Pressure Level (H/M/L speed)			dB(A) 33 / 30 / 28		34 / 32 / 30		36 / 33 / 30	34 / 32 / 29	
Pipe Connections	Liquid	in. 1/4 (Flare)							
	Gas	in. 1/2 (Flare)							
	Condensate Drain	in. VP25							
Refrigerant Control			Electronic Expansion Valve						
Maximum Overcurrent Protection Device			A 15						
Minimum Circuit Ampacity			A 0.8				1.4	1.6	

SPECIFICATIONS			2.0 TON	2.5 TON	3.0 TON	4.0 TON	4.5 TON	
Model Name			FXSQ24TAVJU	FXSQ30TAVJU	FXSQ36TAVJU	FXSQ48TAVJU	FXSQ54TAVJU	
Capacity Index			24	30	36	48	54	
Power Supply			208/230VAC, 60Hz, 1 phase					
Nominal Cooling Capacity*1			Btu/h (kW)	24,000 (7.1)	30,000 (9.0)	36,000 (11.2)	48,000 (14.0)	54,000 (15.8)
Nominal Heating Capacity*2			Btu/h (kW)	27,000 (8.0)	34,000 (10.0)	40,000 (11.7)	54,000 (16.0)	60,000 (17.6)
Fan	Type	Sirocco fan						
	Motor Output	W	230			300		350
	Air Flow Rate (H/M/L)	CFM	742 / 618 / 512	812 / 689 / 565		1130 / 953 / 795	1307 / 1112 / 918	1377 / 1183 / 989
	Drive Type	DC Direct Drive						
	External Static Pressure (Std./Max)	0.4 / 0.6						0.4 / 0.56
Height			in. 9-11/16					
Width			in. 39-3/8		55-1/8		61	
Depth			in. 31-1/2					
Weight			lb. 82 (37)		101 (46)	104 (47)	115 (52)	
Condensate Pump Lift			in. 25-5/16 (643 mm)					
Sound Pressure Level (H/M/L speed)			dB(A) 36 / 32 / 29		39 / 35 / 32		42 / 38.5 / 35	43 / 40 / 36
Pipe Connections	Liquid	in. 3/8 (Flare)					42 / 38.5 / 35	43 / 40 / 36
	Gas	in. 5/8 (Flare)					42 / 38.5 / 35	43 / 40 / 36
	Condensate Drain	in. VP25					42 / 38.5 / 35	43 / 40 / 36
Refrigerant Control			Electronic Expansion Valve					
Maximum Overcurrent Protection Device			A 15					
Minimum Circuit Ampacity			A 1.8		2.5	2.8	3.3	

**Note:** \*1 Nominal cooling capacities are based on the following conditions: 80 °FDB / 67 °FWB (26.7 °CDB / 19.4 °CWB) return air temperature; 95 °FDB (35 °CDB) outdoor temperature; 25 ft. (7.6 m) equivalent refrigerant piping.

\*2 Nominal heating capacities are based on the following conditions: 70 °FDB (21.1 °CDB) return air temperature; 47 °FDB / 43 °FWB (8.3 °CDB / 6.1 °CWB) outdoor temperature; 25 ft. (7.6 m) equivalent refrigerant piping.

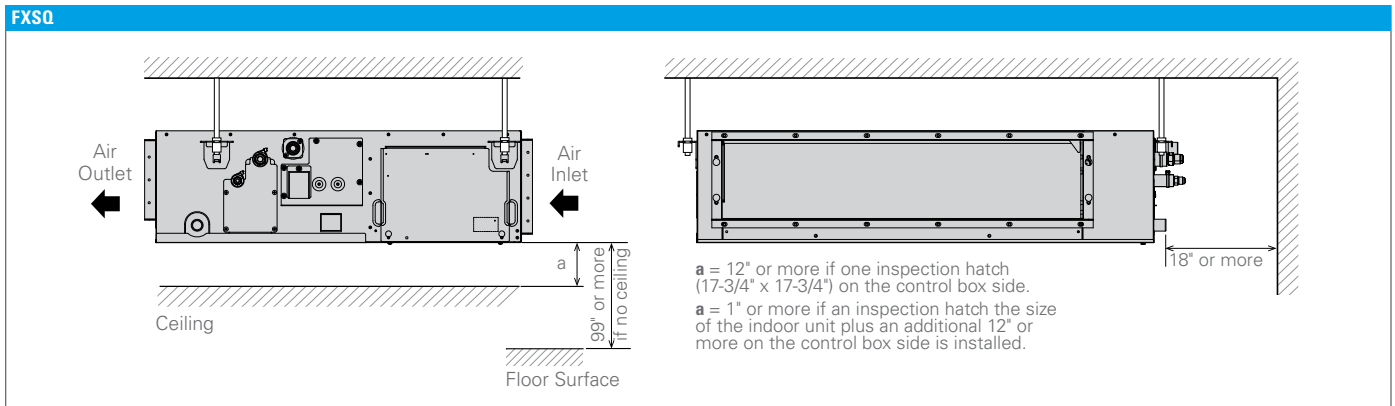

## FXDQ\_MVJU

# LSP Slim Concealed Ducted Unit



Condensate Pump  
as Standard



Outside Air  
Integration Possible



Filter  
Included

### Concealed, Slim, Quiet, Comfortable

The LSP slim concealed unit is available for use with the VRV systems to complement the existing concealed ceiling unit options. With its low profile and low sound level this unit can be installed into limited ceiling void, bulkhead or soffit space.

### Features and Benefits

- » Slim height, at only 7-7/8", makes it suitable for most of the applications where attic / bulkhead space is limited
- » With a sound level down to 29 dB(A) these units are among the quietest on the market
- » Factory shipped for rear air inlet — field convertible to bottom air inlet
- » Washable filter included
- » Condensate pump with vertical lift of up to 21-5/8" included as standard
- » Blends unobtrusively with any interior decor; only the suction and discharge grills are visible



BRC1E73  
(option)



AZAI6WSCDKA  
(option)



BRC2A71  
(option)



BRC4C82  
(option)

### Applications

- » Hotel rooms
- » Multi-family residences
- » Single family residences
- » School dormitories

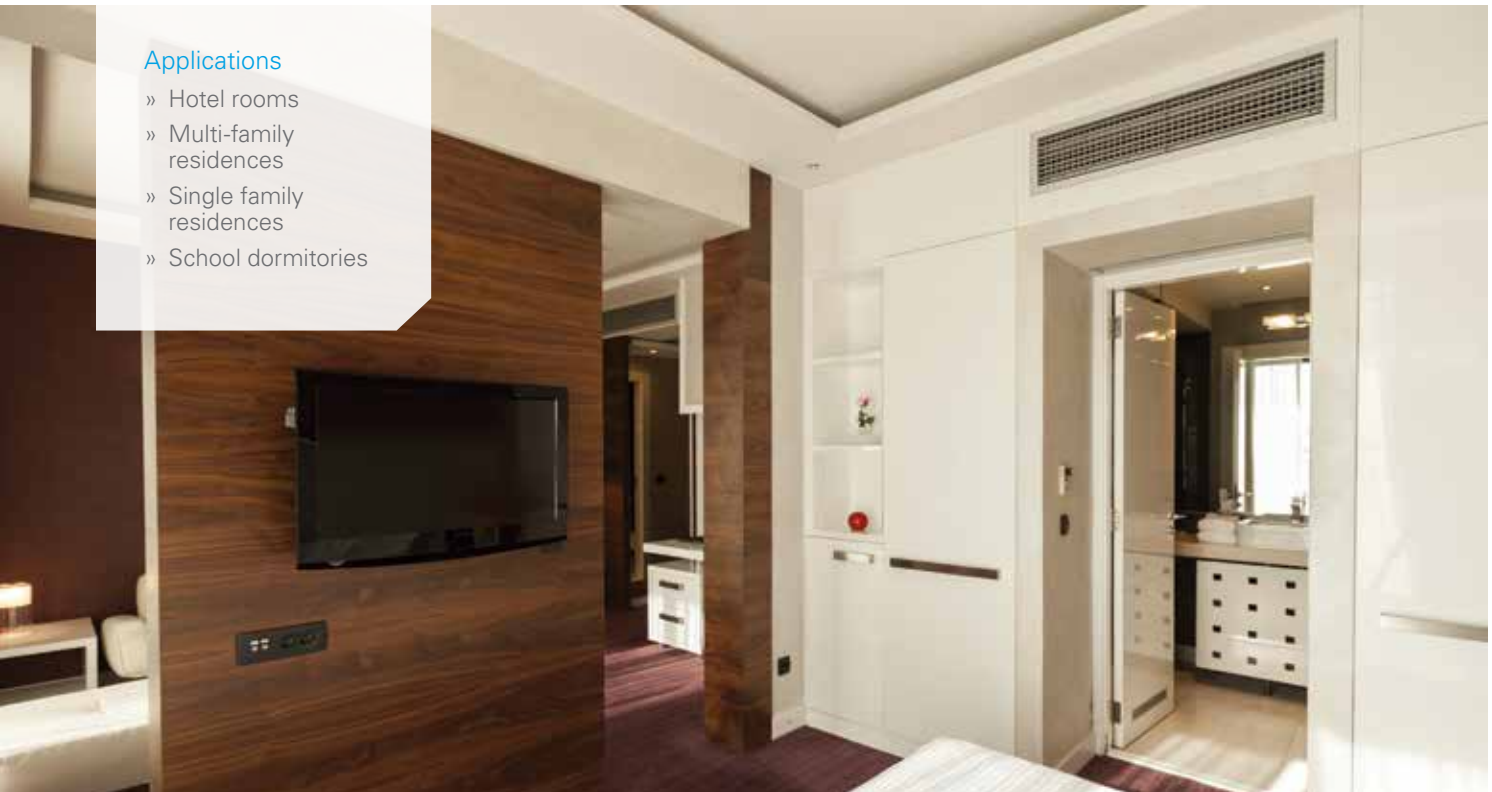

FXDQ_MVJU SPECIFICATIONS			0.6 TON	0.75 TON	1 TON	1.5 TONS	2 TONS
Model Name			FXDQ07MVJU	FXDQ09MVJU	FXDQ12MVJU	FXDQ18MVJU	FXDQ24MVJU
Power Supply	V/ph/Hz		208-230/1/60				
Rated Cooling Capacity	BTU/h		7,500	9,500	12,000	18,000	24,000
Rated Heating Capacity	BTU/h		8,500	10,500	13,500	20,000	27,000
Airflow Rate (H/L)	CFM		280/226			440/350	580/460
Weight	lbs.		51			63	71
Height	in.		7-7/8				
Width	in.		27-9/16			35-7/16	43-5/16
Depth	in.		24-7/16				
Sound Pressure (H/L)	dB(A)		33/29			35/31	36/32
Condensate Pump Lift	in.		21-5/8				
Condensate Pipe Connection	in. O.D.		1-1/32				
Pipe Connections	Gas	in.	1/2 (Flare)				5/8 (Flare)
	Liquid	in.	1/4 (Flare)				3/8 (Flare)
Refrigerant			R-410A				
Refrigerant Control			Electronic Expansion Valve				
Maximum Overcurrent Protective Device	A		15				
Minimum Circuit Amps	A		0.9			1.3	1.4
Protection Devices			Fuse and Fan Motor Thermal Protector				
External Finish			Galvanized Steel Plate				
Standard Filter Type			Removable, Washable, Mildew Proof				
External Static Pressure (H/L)	in. Wg		0.12/0.04			0.17/0.06	0.17/0.06

**Nominal Conditions:**

**Cooling Mode**  
 Indoor: 80 °F DB / 67 °F WB  
 Outdoor: 95 °F DB  
 Pipe Length: 25 ft.  
 Level Difference: 0 ft.

**Heating Mode**  
 Indoor: 70 °F DB  
 Outdoor: 47 °F DB / 43 °F WB  
 Pipe Length: 25 ft.  
 Level Difference: 0 ft.

**Note:** Specifications are subject to change without notice.

FXDQ_MVJU ACCESSORIES					
Model Name	FXDQ07MVJU	FXDQ09MVJU	FXDQ12MVJU	FXDQ18MVJU	FXDQ24MVJU
Navigation™ Remote Controller*			BRC1E73		
DKN Cloud Wi-Fi Adaptor			AZAI6WSCDKA		
Simplified Wired Remote Controller*			BRC2A71		
Wireless Remote Controller			BRC4C82		
Remote Sensor Kit			KRCS01-1B		
Wiring Adaptor PCB (interface with aux/primary heater, humidifier, OA damper/fan)			KRP1C75		
Group Control Adaptor PCB (connects to external BMS)			KRP4A74		
Access Panel (single door)		APFXDQ070912		APFXDQ18	APFXDQ24
Access Panel with return air filter (single door)		APRFFXDQ070912		APRFFXDQ18	APRFFXDQ24
Filter Media Replacement		APRFFXDQ070912F		APRFFXDQ18F	APRFFXDQ24F

\* Optional face plates available to provide a more intuitive user interface and disable specific functions

**FXDQ\_MVJU INSTALLATION SPACE**

Choose an installation site that ensures both optimum air distribution and sufficient clearance for maintenance.

The return air inlet can be easily changed from rear to bottom using the same chamber lid.

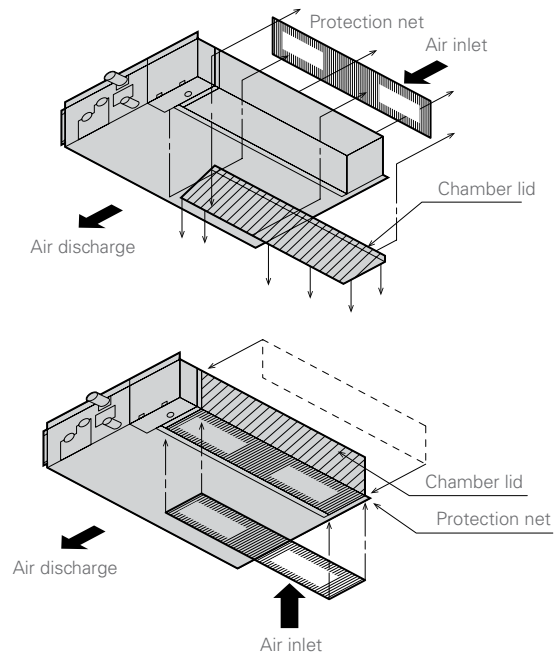
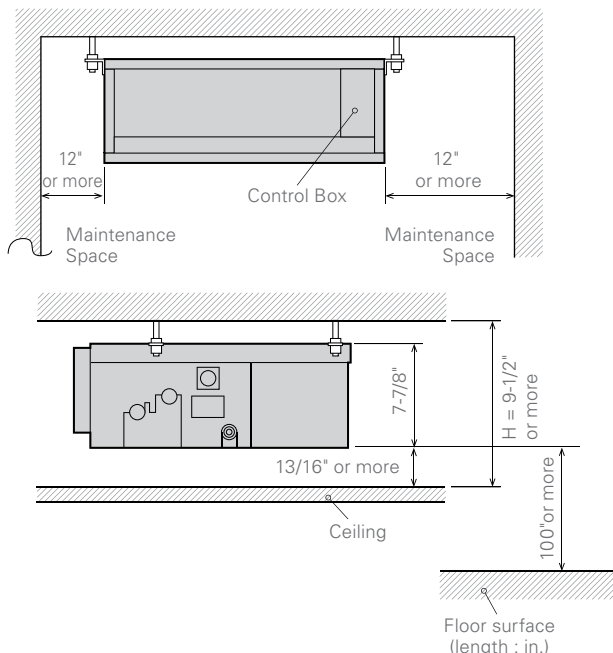

# FXTQ\_TAVJUA(D)

## Multi-Position Air Handling Unit



Outside Air Integration Possible



All Aluminum Coil



Variable Speed ECM Motor

### Outstanding flexibility and performance

The FXTQ\_TAVJUA(D) air handler features full multi-position\* flexibility to meet the most demanding installation conditions. A multitude of features ensure reliable, efficient performance year round.

#### Features and Benefits

- » Expanded capacity lineup, featuring ten models ranging from ¾ ton to 5 tons, with a redesigned\*\* unit frame for maximum durability.
- » Full multi-position air handler capable of upflow, downflow\*, horizontal right, and horizontal left installation.
- » A high efficiency, ECM motor powers the fan to deliver nominal CFM at up to 0.9" in. Wg static. An auto fan speed setting automatically adjusts the fan speed through 5 steps based on the load in the space.
- » Wide line up of electric heat (field installed) options from 3kW to 25kW.
- » An auxiliary heat logic features a reduced heater operation deadband and the ability to run both heat pump and auxiliary heat for maximum comfort and performance in colder climates. The auxiliary heat can be interlocked with the ambient temperature sensed by the outdoor unit.
- » Designed with less than 2% air leakage when tested in accordance with ASHRAE standard 193.
- » New integrated control board reduces\*\* the number of electrical connections required. Quick disconnect control wiring terminals simplify installation.
- » Easily integrate with third party accessories such as a humidifier or economizer with on-board contacts.



- » Up to 200% connection ratio is possible on applicable VRV IV systems.
- » Available with optional factory installed disconnect (Built to order — model FXTQ\_TAVJUD).

\*Downflow requires field installed optional downflow accessory. (Part number DFK-B/C/D)  
 \*\*Compared to previous model FXTQ\_P

### Designed for Compact Spaces

With its compact and space saving design, the new FXTQ\_TAVJUA(D) air handler units are engineered to suit most light commercial and residential applications.

- » At under 46" tall and only 17-1/2" wide up to 3 tons, the FXTQ\_TAVJUA(D) can be installed in tight closet spaces.
- » Designed for zero clearance on three sides and only 24" clearance on the front for service.
- » Sound levels as low as 36 dBA to suit applications in sound sensitive environments.

#### Applications

- » Multi-family
- » Single-family
- » Hotels
- » Offices

### Electric Heater Options

ELECTRICAL HEATER CAPACITY									
Model Name	3kW	5kW	6kW	8kW	10kW	15kW	19kW	20kW	25kW
FXTQ09TAVJUA(D)	■	■							
FXTQ12TAVJUA(D)	■	■	■						
FXTQ18TAVJUA(D)	■	■	■	■	■				
FXTQ24TAVJUA(D)	■	■	■	■	■				
FXTQ30TAVJUA(D)	■	■	■	■	■				
FXTQ36TAVJUA(D)	■	■	■	■	■				
FXTQ42TAVJUA(D)		■	■	■	■	■	■		
FXTQ48TAVJUA(D)		■	■	■	■	■	■		
FXTQ54TAVJUA(D)		■	■	■	■	■		■	■
FXTQ60TAVJUA(D)		■	■	■	■	■		■	■

SPECIFICATIONS			0.75 TON	1 TON	1.5 TON	2 TON	2.5 TON
Model Name			FXTQ09TAVJUA	FXTQ12TAVJUA	FXTQ18TAVJUA	FXTQ24TAVJUA	FXTQ30TAVJUA
Model Name (With factory disconnect)			FXTQ09TAVJUD	FXTQ12TAVJUD	FXTQ18TAVJUD	FXTQ24TAVJUD	FXTQ30TAVJUD
Power Supply		V/ph/Hz	208/230VAC, 60Hz, 1 phase				
Nominal Cooling Capacity*1		Btu/h	9,500	12,000	18,000	24,000	30,000
Nominal Heating Capacity*2		Btu/h	10,500	13,500	20,000	27,000	34,000
Fan	Type		Sirocco FC Centrifugal				
	Motor Output	HP	1/2				
	Air Flow Rate (H/M/L)	CFM	300 / 275 / 250	400 / 340 / 280	600 / 510 / 420	800 / 680 / 560	1000 / 850 / 700
	Static Pressure*3	in. Wg	0.18" / 0.9"				
Drive Type			Variable speed ECM				
Height		in.	45				
Width		in.	17.5				
Depth		in.	21				
Weight (net) (TAVJUA/TAVJUD)		lbs.	105/108	112/115	111/118	112/115	113/116
Sound Pressure Level (H speed)		dB(A)	36		45		52
Pipe Connections	Liquid	in.	1/4 (Braze)			3/8 (Braze)	
	Gas	in.	1/2 (Braze)			5/8 (Braze)	
	Condensate Drain	in.	3/4 (fpt)				
Refrigerant Control			Electronic Expansion Valve				
Maximum Overcurrent Protective Device		A	15				
Minimum Circuit Amps		A	4.9				

SPECIFICATIONS			3 TON	3.5 TON	4 TON	4.5 TON	5 TON
Model Name			FXTQ36TAVJUA	FXTQ42TAVJUA	FXTQ48TAVJUA	FXTQ54TAVJUA	FXTQ60TAVJUA
Model Name (With factory disconnect)			FXTQ36TAVJUD	FXTQ42TAVJUD	FXTQ48TAVJUD	FXTQ54TAVJUD	FXTQ60TAVJUD
Power Supply		V/ph/Hz	208/230VAC, 60Hz, 1 phase				
Nominal Cooling Capacity*1		Btu/h	36,000	42,000	48,000	54,000	60,000
Nominal Heating Capacity*2		Btu/h	40,000	46,000	54,000	60,000	66,000
Fan	Type		Sirocco FC Centrifugal				
	Motor Output	HP	1/2	3/4		1.0	
	Air Flow Rate (H/M/L)	CFM	1050 / 900 / 750	1400 / 1190 / 980	1520 / 1290 / 1060	1800 / 1530 / 1260	1800 / 1530 / 120
	Static Pressure*3	in. Wg	0.23" / 0.9"				0.28" / 0.9"
Drive Type			Variable speed ECM				
Height		in.	45	53.43		58	
Width		in.	17.5	21		24.5	
Depth		in.	21				
Weight (net) (TAVJUA/TAVJUD)		lbs.	113/116	144/147		165/168	
Sound Pressure Level (H speed)		dB(A)	52	54		50	
Pipe Connections	Liquid	in.	3/8 (Braze)				
	Gas	in.	5/8 (Braze)				
	Condensate Drain	in.	3/4 (fpt)				
Refrigerant Control			Electronic Expansion Valve				
Maximum Overcurrent Protective Device		A	15				
Minimum Circuit Amps		A	4.9	6.5		8.6	

\*1 Nominal cooling capacities are based on the following conditions: 80 °FDB / 67 °FWB (26.7 °CDB / 19.4 °CWB) return air temperature; 95 °FDB (35 °CDB) outdoor temperature; 25 ft. (7.6 m) equivalent refrigerant piping.

\*2 Nominal heating capacities are based on the following conditions: 70 °FDB (21.1 °CDB) return air temperature; 47 °FDB / 43 °FWB (8.3 °CDB / 6.1 °CWB) outdoor temperature; 25 ft. (7.6 m) equivalent refrigerant piping.

\*3 External static pressures are indicated as rated / maximum allowable range.

## FXMQ\_MVJU

# HSP High Capacity Concealed Ducted Unit



Outside Air  
Integration Possible

### Concealed, Slim Design, Strong, Comfortable

The FXMQ\_MVJU ducted fan coil unit is ideal for larger open space floor plans usually found in offices, retails, hotels, or education facilities. It performs well across multiple spaces that can benefit from the same mode of operation, limiting equipment and installation cost.



### Features and Benefits

- » Design flexibility with a capacity range up to 96 MBH
- » Improved ductwork and filtration flexibility with ESP capabilities of up to 1.1" W.G.
- » Low profile design of less than 19" high to reduce required installation space



BRC1E73  
(option)



AZAI6WSCDKA  
(option)



BRC2A71  
(option)



BRC4C82  
(option)

### Applications

- » Hotel/conference centers
- » Schools
- » Retail/shopping centers
- » Large open-plan offices
- » Churches

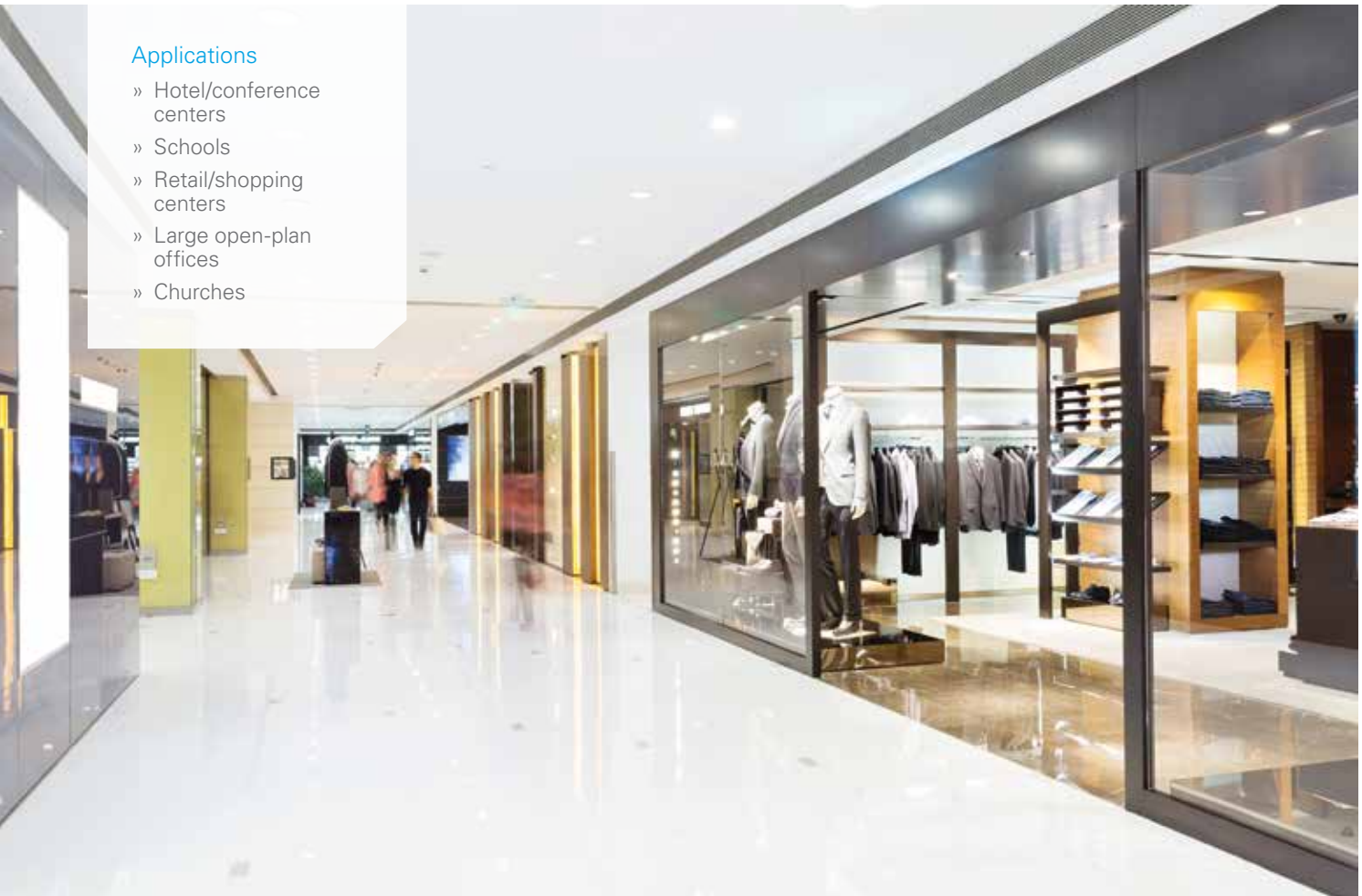

FXMQ_MVJU SPECIFICATIONS		6 TON	8 TON
Model Name		FXMQ72MVJU	FXMQ96MVJU
Power Supply	V/ph/Hz	208-230/1/60	
Rated Cooling Capacity	BTU/h	72,000	96,000
Rated Heating Capacity	BTU/h	81,000	108,000
Airflow Rate (H/L)	CFM	2,047/1,764	2,541/2,188
Weight	lbs.	380	
Height	in.	18-1/8	
Width	in.	54-3/8	
Depth	in.	43-5/16	
Sound Pressure (H/L)	dB(A)	48/45	
Condensate Pipe Connection	in. O.D.	1	
Pipe Connections	Gas	3/4 (Flare)	7/8 (Flare)
	Liquid	3/8 (Flare)	
Refrigerant		R-410A	
Refrigerant Control		Electronic Expansion Valve	
Maximum Overcurrent Protective Device	A	15	
Minimum Circuit Amps	A	9.5	10.7
Protection Devices		Fuse and Fan Motor Thermal Protector	
External Finish		Galvanized Steel Plate	
External Static Pressure (Nominal/Maximum)	in. Wg	0.38/0.95	0.43/1.1

**Nominal Conditions:**

**Cooling Mode**  
 Indoor: 80 °F DB / 67 °F WB  
 Outdoor: 95 °F DB  
 Pipe Length: 25 ft.  
 Level Difference: 0 ft.

**Heating Mode**  
 Indoor: 70 °F DB  
 Outdoor: 47 °F DB / 43 °F WB  
 Pipe Length: 25 ft.  
 Level Difference: 0 ft.

Note: Specifications are subject to change without notice.

FXMQ_MVJU ACCESSORIES		
Model Name	FXMQ72MVJU	FXMQ96MVJU
Navigation™ Remote Controller*		BRC1E73
DKN Cloud Wi-Fi Adaptor		AZAI6WSDKA
Simplified Wired Remote Controller*		BRC2A71
Wireless Remote Controller		BRC4C82
Remote Sensor Kit		KRCS01-1B
Wiring Adaptor PCB (interface with aux/primary heater, humidifier, OA damper/fan)		KRP1C74
Group Control Adaptor PCB (connects to external BMS)		KRP4A71
High Efficiency Filter Kit (MERV 13)		DACA-MQ96M-13-1K
High Efficiency Filter Kit (MERV 8)		DACA-MQ96M-8-1K

\* Optional face plates available to provide a more intuitive user interface and disable specific functions

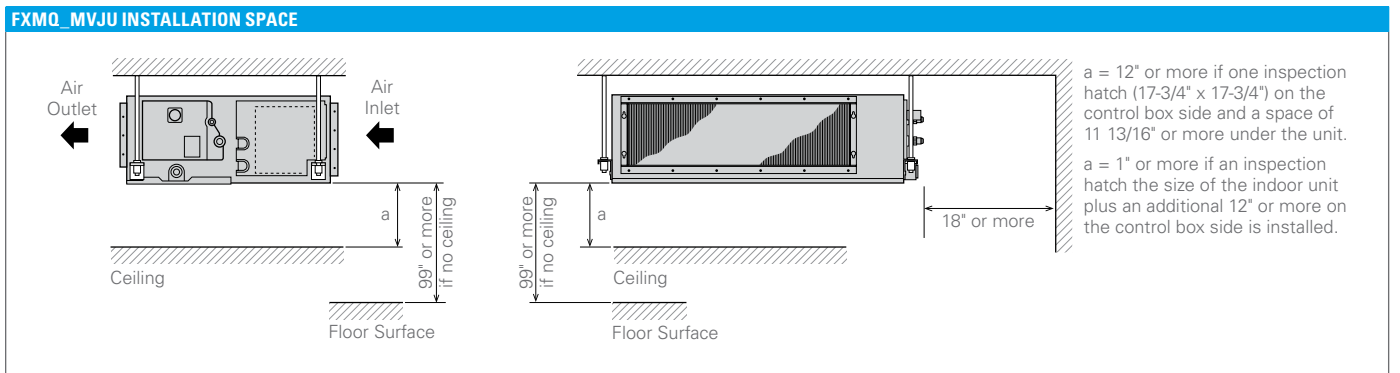

INDOOR UNITS

# FXNQ\_MVJU9

## Concealed Floor-Standing Unit



Outside Air Integration Possible

Filter Included

### Versatile, Logical, Durable, Quiet

The ideal way to save space, our floor-standing units can easily be installed along a perimeter wall — or concealed. The air distribution from these models will allow you to find the right balance for classrooms, churches, office hallways or similar spaces. The concealed floor units cover a wide range of capacities and can be built into counter in order to maintain the aesthetics of the room.



### Features and Benefits

- » Ideal for installation beneath a window
- » Unit requires minimal installation space
- » Fitted with a washable long-life filter
- » Remote-control options available
- » Space-saving unit can be freestanding or wall-mounted, concealed or exposed
- » Models range from 7.5 MBH to 24 MBH



BRC1E73 (option)



AZAI6WSCDKA (option)



BRC2A71 (option)



BRC4C82 (option)

### Applications

- » Multi-family residences
- » Single-family residences
- » Churches
- » Historic buildings
- » Schools
- » Offices





FXNQ_MVJU9 SPECIFICATIONS		0.6 TON	0.75 TON	1 TON	1.5 TON	2 TON
Model Name		FXNQ07MVJU9	FXNQ09MVJU9	FXNQ12MVJU9	FXNQ18MVJU9	FXNQ24MVJU9
Power Supply	V/ph/Hz	208-230/1/60				
Rated Cooling Capacity	BTU/h	7,500	9,500	12,000	18,000	24,000
Rated Heating Capacity	BTU/h	8,500	10,500	13,500	20,000	27,000
Airflow Rate (H/L)	CFM	245/210		280/210	490/380	560/420
Weight	lbs.	47		56	60	
Height	in.	24				
Width	in.	36-5/8		42-1/8	53-1/8	
Depth	in.	8-5/8				
Sound Pressure (H/L)	dB(A)	35/32		36/33	40/35	41/36
Condensate Pipe Connection	in. O.D.	27/32				
Pipe Connections	Gas	in.				5/8
	Liquid	in.				3/8
Refrigerant		R-410A				
Refrigerant Control		Electronic Expansion Valve				
Maximum Overcurrent Protective Device	A	15				
Minimum Circuit Amps	A	0.3		0.5	0.6	
Protection Devices		Fuse and Fan Motor Thermal Protector				
External Finish		Galvanized Steel Plate				
Standard Filter Type		Resin Net (with Mold Resistant)				

**Nominal Conditions:**

**Cooling Mode**

Indoor: 80 °F DB / 67 °F WB  
 Outdoor: 95 °F DB  
 Pipe Length: 25 ft.  
 Level Difference: 0 ft.

**Heating Mode**

Indoor: 70 °F DB  
 Outdoor: 47 °F DB / 43 °F WB  
 Pipe Length: 25 ft.  
 Level Difference: 0 ft.

Note: Specifications are subject to change without notice.

**FXNQ\_MVJU9 ACCESSORIES**

Model Name	FXNQ07MVJU9	FXNQ09MVJU9	FXNQ12MVJU9	FXNQ18MVJU9	FXNQ24MVJU9
Navigation™ Remote Controller			BRC1E73		
DKN Cloud Wi-Fi Adaptor			AZAIGWSCDKA		
Simplified Wired Remote Controller*			BRC2A71		
Wireless Remote Controller			BRC4C82		
Remote Sensor Kit			KRCS01-1B		
Wiring Adaptor PCB (interface with aux/primary heater, humidifier, OA damper/fan)			KRP1C74		
Group Control Adaptor PCB (connects to external BMS)			KRP4A71		
Condensate Pump			DACA-CP3-1		

\* Optional face plates available to provide a more intuitive user interface and disable specific functions

**FXNQ\_MVJU9 INSTALLATION SPACE**

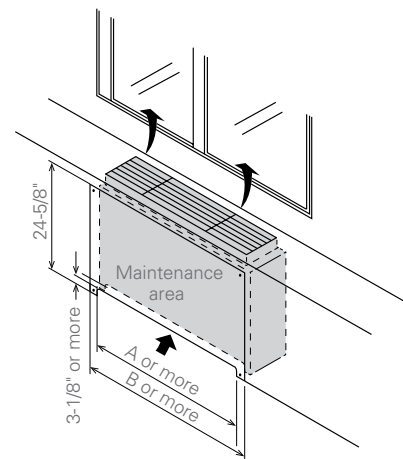
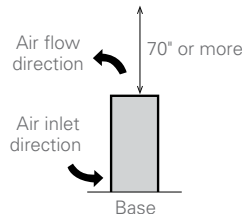
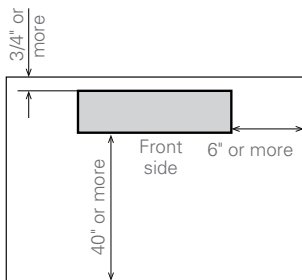

**IMPORTANT**  
 Leave sufficient clearance for air inlet and maintenance.

MODEL	A (IN.)	B (IN.)
FXNQ12MVJU9	28	46
FXNQ18 - 24MVJU9	39	57
FXNQ07-09MVJU	23	41

# Round Flow Sensing Cassette



Condensate Pump as Standard  
 Outside Air Integration Possible  
 Filter Included



Optional Auto Cleaning Filter  
 Surface & Occupancy Sensor Kit as Standard

## Adaptive Comfort Control

The Round Flow Sensing Cassette is ideal for open plan applications such as classrooms and offices where adaptive comfort control is preferred. The unit provides an excellent comfort level, energy efficiency, and flexibility due to advanced control functions based on input from three room sensors (occupancy, air temperature, and surface temperature). With 18 configurable airflow distribution patterns, it can be efficient and provide a comfortable environment in smaller, more intricate spaces as well.

## Features and Benefits

- » Capacity range from 7.5 to 48 MBH.
- » True 360° Airflow and three room sensors enables optimized occupant comfort and efficiency
- » Energy efficient with DC fan motor and auto-logic that adjusts fan speed based on space load
- » Optional self-cleaning air filter panel to further increase efficiency and reduce maintenance costs, when used in VRV IV systems
- » Very flexible with 18 different possible airflow patterns, ensuring ideal air distribution to maximize comfort and efficiency
- » Compact design to allow for installation in small ceiling voids
- » Sound pressure levels as low as 27 db(A)
- » Enhanced indoor air quality and LEED ready with MERV 13 filter options

The built-in occupancy sensor has two main functions: save energy and optimize occupancy comfort. In order to save energy, the function of the occupancy sensor can be used to automatically set back the air temperature and also lower the fan speed if no people are present in the room.

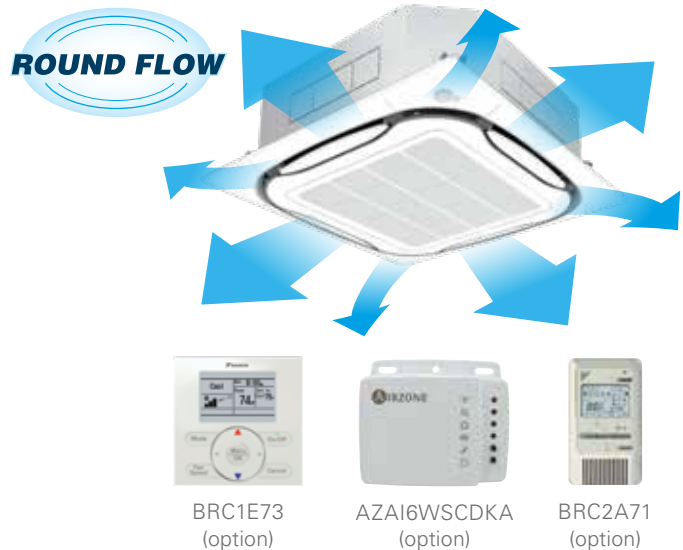

Together with the occupancy sensor, the air-temperature sensor and the built-in surface temperature sensor are used to maintain an even and comfortable temperature distribution from floor to ceiling in the room. This is done by automatically adjusting the supplied airflow rate and the individual position of each of the four supply air louvers in the unit, thus maintaining the required comfortable space environment.

In order to further increase efficiency and reduce maintenance costs, the Round Flow Sensing Cassette can be equipped with an optional self-cleaning filter panel that performs automatic air-filter cleaning up to once a day. Dust is deposited into a collection box during the self-cleaning process. When indicated with light on the unit and on the controller display, the dust collection box in the unit can easily and quickly be emptied with a standard vacuum cleaner.

## Applications

- » Retail
- » Schools
- » Offices
- » Restaurants

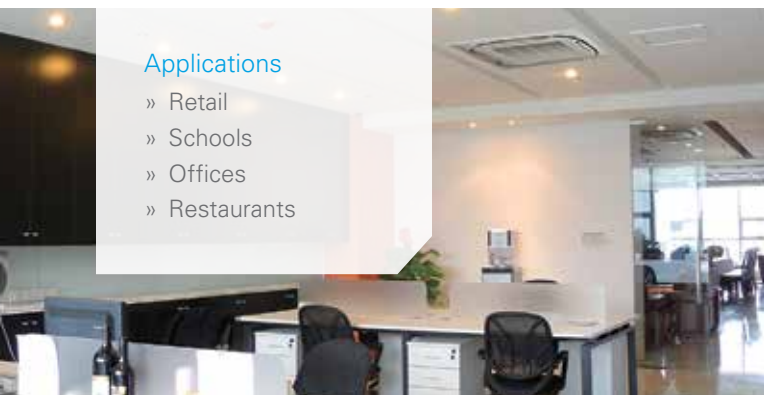

## 4-way flow vs. Round Flow

Round Flow Ceiling Mounted Cassette type offers 360° airflow with improved temperature distribution.

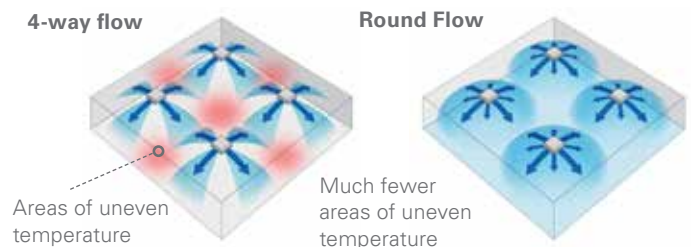

Advanced design for comfort and efficiency

**Heat Exchanger Design**

Optimized for part load operation — great enhancement to seasonal energy efficiency

**Occupancy and Surface Temperature Sensors**

Enables additional energy savings and increased comfort

**Optional Self-Cleaning Filter Panel**

Provides optimum efficiency, airflow and reduced maintenance

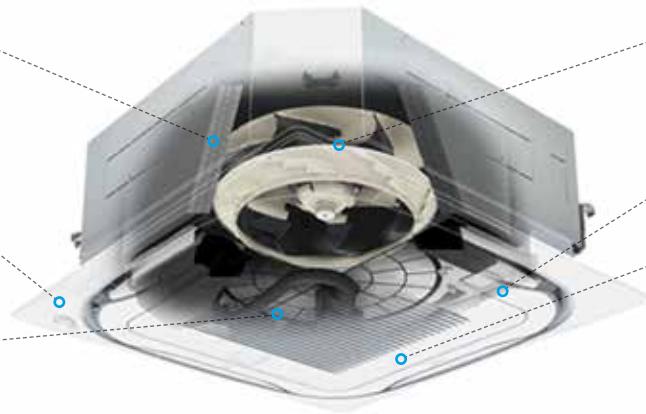

**DC Fan Motor**

Very efficient — enables fan auto logic based on  $\Delta T$  set point

**DC Drain Pump**

Low power consumption

**Decoration Panel**

- » Efficient due to large air discharge outlets
- » Unique 360° airflow distribution
- » 4 individually controlled louvers enables optimized comfort in the space
- » Possibility to close 1, 2 or 3 louvers adds flexibility

Automatic air-direction control



Air flow from the indoor unit is automatically adjusted to always maintain a comfortable environment — even when occupancy changes.

Dual infrared sensors

Sensors detect the presence of people and surface temperature to provide comfortable air-conditioning and energy savings.

**Infrared presence sensor**

The sensor detects human presence, and energy saving control can be performed when no people are detected.

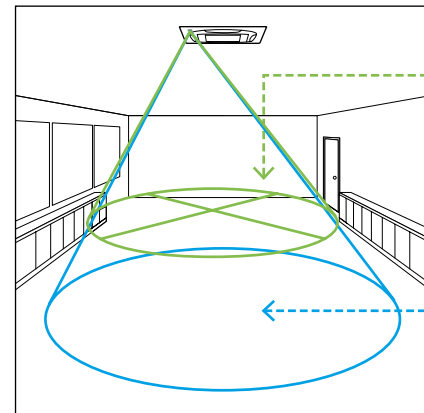

**Infrared surface sensor**

The sensor detects the surface temperature and automatically adjusts operation of the indoor unit to reduce the temperature difference between the ceiling and the floor.

# FXFQ\_TVJU (cont.)

## Round Flow Sensing Cassette



Condensate Pump as Standard



Outside Air Integration Possible



Filter Included



Optional Auto Cleaning Filter



Surface & Occupancy Sensor Kit as Standard

Automatic air filter cleaning (optional)

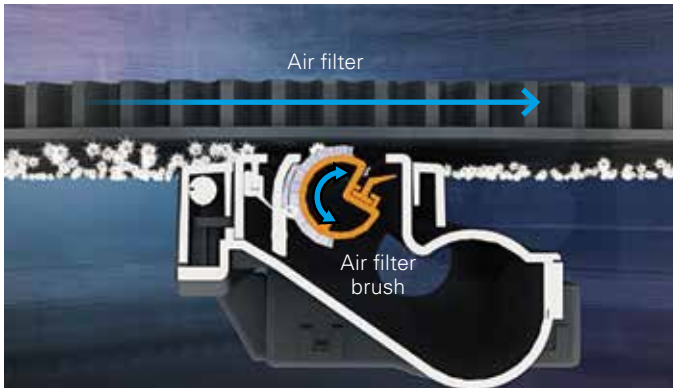

At the programmed time, the air filter rotates while the air filter brush turns back and forth to brush the filter.

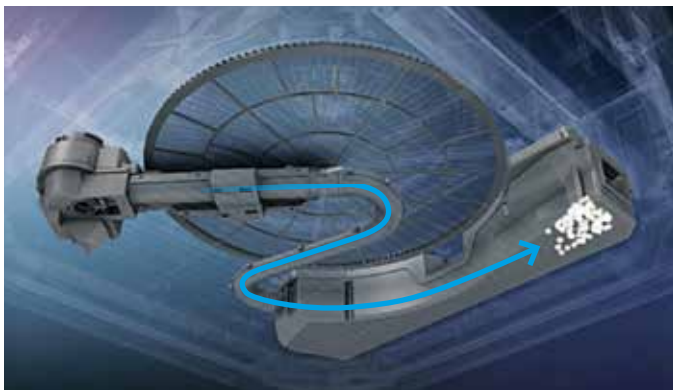

Dust from the air filter brush is deposited into the dust collection container during the fully automatic self-cleaning process.

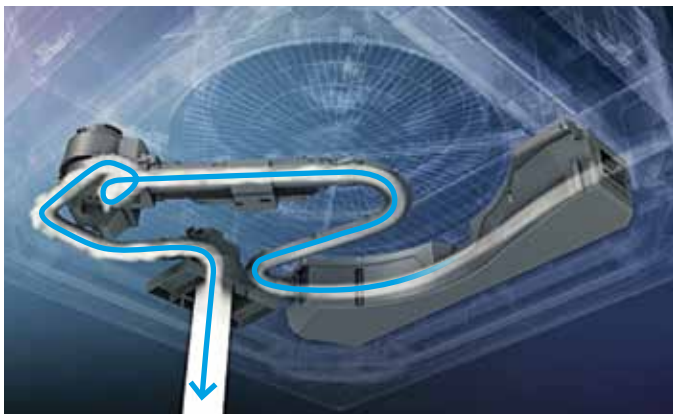

When indicated, the dust container in the unit is easily emptied with a standard vacuum cleaner.



INDOOR UNITS

FXFQ_TVJU SPECIFICATIONS			0.60 TON	0.75 TON	1 TON	1.25 TON	1.5 TON	2 TON	2.5 TON	3 TON	4 TON		
Model Name			FXFQ07TVJU	FXFQ09TVJU	FXFQ12TVJU	FXFQ15TVJU	FXFQ18TVJU	FXFQ24TVJU	FXFQ30TVJU	FXFQ36TVJU	FXFQ48TVJU		
Power Supply		(V/ph/Hz)	208-230/1/60										
Rated Cooling Capacity		BTU/h	7,500	9,500	12,000	15,000	18,000	24,000	30,000	36,000	48,000		
Rated Heating Capacity		BTU/h	8,500	10,500	13,500	17,000	20,000	27,000	34,000	40,000	54,000		
Airflow Rate (H/M/L)		CFM	420/406/353	441/406/353	441/406/353	512/459/388	742/618/477	777/618/477	1,112/918/671	1,165/918/671	1,218/971/742		
Weight		lbs.	48				48			58			
Height		in.	9-11/16						11-5/16				
Width		in.	33-1/16						33-1/16				
Depth		in.	33-1/16						33-1/16				
Sound Pressure (H/M/L)		dB(A)	30/28.5/27			31/29/27	35.5/32/28	36/32/28	43.5/38/32	44/38/32	45/40/35		
Condensate Pump Lift		in.	33-1/2						33-1/2				
Condensate Pipe Connection		in. O.D.	1-1/4						1-1/4				
Pipe Connections		Gas	in.				1/2 (Flare)			5/8 (Flare)			
		Liquid	in.				1/4 (Flare)			3/8 (Flare)			
Refrigerant			R-410A										
Refrigerant Control			Electronic Expansion Valve										
Maximum Overcurrent Protective Device		A	15										
Minimum Circuit Amps		A	0.3		0.4		0.6		0.7		1.3	1.5	1.8
Protection Devices			Fuse/Breaker and Fan Motor Thermal Protector										
External Finish			Galvanized Steel Plate										
Standard Filter Type			Mold-Resistant Resin Net										

**Nominal Conditions:**

**Cooling Mode**

Indoor: 80 °F DB / 67 °F WB  
 Outdoor: 95 °F DB  
 Pipe Length: 25 ft.  
 Level Difference: 0 ft.

**Heating Mode**

Indoor: 70 °F DB  
 Outdoor: 47 °F DB / 43 °F WB  
 Pipe Length: 25 ft.  
 Level Difference: 0 ft.

Note: Specifications are subject to change without notice.

OPTION			FXFQ09-48TVJU	
Type of panel			Self-Cleaning Filter Panel	Standard Sensing Decoration Panel
Self-Cleaning Filter Panel			BYCQ125BGW1	-
Connection pipe (for dust recovery)			KKHAP55B160	-
L-shape extension pipe			KKHAP55A160	-
Standard Sensing Decoration Panel			-	BYCQ125B-W1
Sealing material for air discharge outlet			KDBH55K160F	KDBHQ55B140
Panel spacer			KDBP55H160FA	KDBP55H160FA
Fresh air intake kit	Chamber type	Without T shape pipe	-	KDDQ55B140
		With T shape pipe	-	KDDP55B160K
Replacement long life filter			-	KAFP55B160
Self-Cleaning Filter Panel replacement filter			KAFP55A160	-
MERV 13 Filter Kit			-	DACA-FQP13-1K

OUTDOOR / CONDENSING UNIT COMPATIBILITY		
Outdoor Condensing Unit	FXFQ_TVJU with:	
	Self-Cleaning Filter Panel (BYCQ125BGW1)	Standard Sensing Decoration Panel (BYCQ125B-W1)
VRV IV-S	Yes	
VRV IV	Yes	
VRV IV W-Series	Yes	
VRV III	No	Yes
SkyAir	No	

**FXFQ\_TVJU INSTALLATION SPACE**

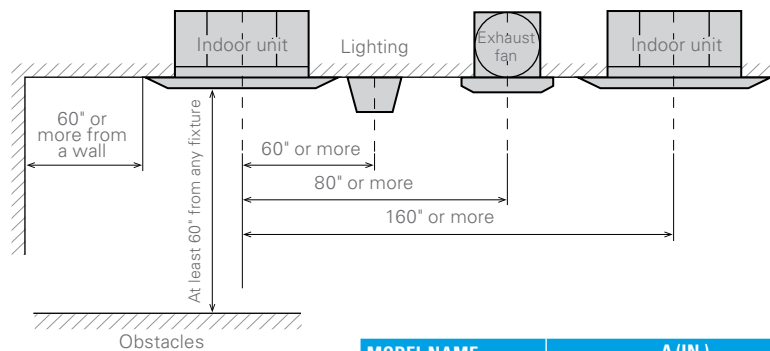

MODEL NAME (FXFQ_TVJU)	A (IN.)	
	BYCQ125B-W1	BYCQ125BGW1
07 · 09 · 12 · 15 · 18 · 24	10	13-1/4
30 · 36 · 48	11-3/4	14-7/8

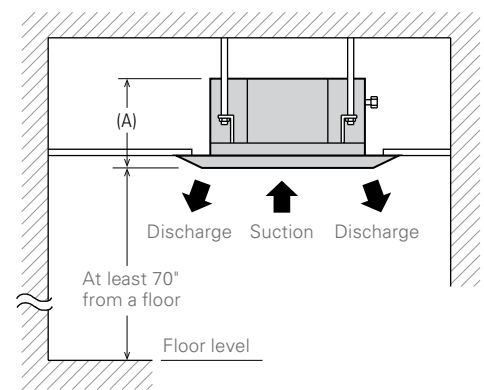

# 4-Way Ceiling-Suspended Cassette



Condensate Pump as Standard



Filter Included



Optional Surface & Occupancy Sensor Kit

## Slim, Stylish, Flexible

The unique 4-way ceiling-suspended cassette is an ideal solution for rooms without a false ceiling, or minimal space above a false ceiling, where adaptive comfort control is preferred.

The optional Sensor Kit (occupancy and surface temperature) together with air temperature sensor and advanced control functions enables the unit to provide an exceptional comfort level, energy efficiency, and flexibility.

## Features and Benefits

- » Very low unit height of under 8" makes it an ideal solution for school, shops, restaurants and offices with no or low false ceilings
- » Optional Sensor Kit enables input from three room sensors to provide optimized occupant comfort and efficiency
- » Stylish unit blends easily with any interior, as the air louvers close entirely when not in operation
- » Energy efficient fan motor
- » Individual air louver control — one or more louvers can be easily closed via the remote controller when required
- » Ideal for both new and existing buildings
- » Can also be mounted partially recessed in a false ceiling
- » Same appearance and size for all capacity models
- » Standard drain pump with 19.5" lift



BRC1E73 (option)



AZAI6WSCDKA (option)



BRC2A71 (option)

## Flexible Airflow Pattern

The four individually controlled air louvers in the unit enables comfortable space environment in a variety of different room layouts.

Air from each louver can be set to exhaust in 5 different angles between 0 and 60 degrees, or set to auto-swing.

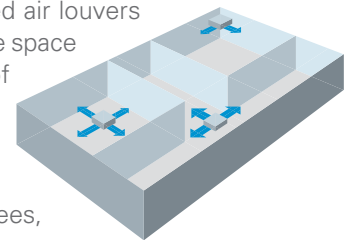

## Applications

- » Retail
- » Schools
- » Offices
- » Restaurants

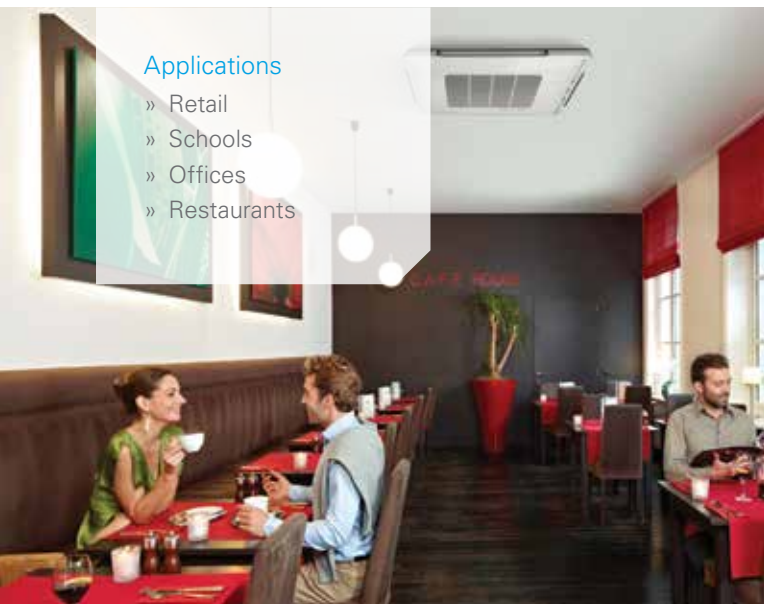

## Airflow Angles

**Auto Swing:** Wide discharge angle: 0° to 60°

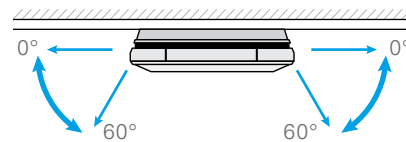

**Fixed angles:** 5 levels

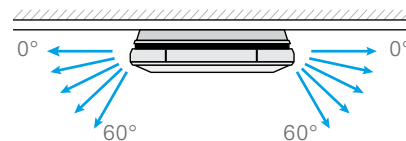

FXUQ_PVJU SPECIFICATIONS		1.5 TON	2 TON	2.5 TON	3 TON
Model Name		FXUQ18PVJU	FXUQ24PVJU	FXUQ30PVJU	FXUQ36PVJU
Power Supply	(V/ph/Hz)	208-230/1/60			
Rated Cooling Capacity	BTU/h	18,000	24,000	30,000	36,000
Rated Heating Capacity	BTU/h	20,000	27,000	34,000	40,000
Airflow Rate (H/M/L)	CFM	795/689/565		1095/918/742	
Weight	lbs.	58			60
Height	in.	7-13/16			
Width	in.	37 3/8			
Depth	in.	37 3/8			
Sound Pressure (H/M/L)	dB(A)	40/38/36		47/44/40	
Condensate Pump Lift	in.	19.5			
Condensate Pipe Connection	in. O.D.	VP20			
Pipe Connections	Gas	in.	1/2 (Flare)	5/8 (Flare)	5/8 (Flare)
	Liquid	in.	1/4 (Flare)	3/8 (Flare)	3/8 (Flare)
Refrigerant		R-410A			
Refrigerant Control		Electronic Expansion Valve			
Maximum Overcurrent Protective Device	A	15			
Minimum Circuit Amps	A	0.6		1.4	
Protection Devices		Fuse and Fan Motor Thermal Protector			
External Finish		White Casing			
Standard Filter Type		Resin Net (with Mold Resister)			

**Nominal Conditions:**

**Cooling Mode**  
 Indoor: 80 °F DB / 67 °F WB  
 Outdoor: 95 °F DB  
 Pipe Length: 25 ft.  
 Level Difference: 0 ft.

**Heating Mode**  
 Indoor: 70 °F DB  
 Outdoor: 47 °F DB / 43 °F WB  
 Pipe Length: 25 ft.  
 Level Difference: 0 ft.

Note: Specifications are subject to change without notice.

FXUQ_PVJU ACCESSORIES				
Model Name	FXUQ18PVJU	FXUQ24PVJU	FXUQ30PVJU	FXUQ36PVJU
Sealing Member of Air Discharge Outlet			KDBHP49B140	
Decoration Panel for Air Discharge			KDBTP49B140	
Replacement Long-Life Filter			KAFP551K160	
Remote Control (wired type)			BRC1E73	
Sensor Kit <sup>2</sup>			BRE49B1F	
DKN Cloud Wi-Fi Adaptor			AZAI6WSDKA	
Group Control Adaptor Printed Circuit Board <sup>1</sup>			KRP4A74	
Installation Box for Adaptor PCB			KRP1BA97	
Remote Sensor <sup>2</sup>			KRCS01-48	

<sup>1</sup> Installation box for Adaptor PCB (KRP1BA97) is necessary. <sup>2</sup> Remote Sensor can only be installed when Sensor Kit is not installed.

**FXUQ\_PVJU INSTALLATION SPACE**

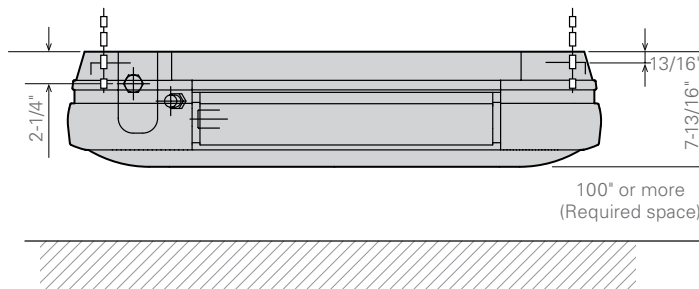

**Automatic air-direction control**



Air-flow from the indoor unit is automatically adjusted to always maintain a comfortable environment — even when occupancy changes.

FXZQ\_TAVJU

# VISTA™ 2 x 2 Cassette Unit for VRV



Condensate Pump as Standard



Outside Air Integration Possible



Filter Included

## Designer Comfort

VISTA™ is a remarkable blend of iconic design and engineering excellence with an elegant white or a silver and white finish. Fitting within the ceiling grid, VISTA™ is stylish, low profile, and compact. Energy efficiency and comfort can be enhanced through the combined use of optional floor and presence sensors. It is also possible to close individual louvers via the wired remote control for personalized comfort.

### Features and Benefits

- » New 0.5 ton (5,800 Btu/h) size.
- » Seamless integration in standard architectural ceiling tiles, eliminating any overlap of adjacent tiles.
- » Energy efficient operation thanks to specially developed small tube heat exchanger and two optional intelligent sensors.
- » The use of a high efficiency DC fan motor reduces operational power input up to 48% compared to the previous generation.
- » Provides high degree of control for auxiliary heating devices, with independently configurable on/off temperature values.
- » Direct integration of fresh air through a factory knock out.



BRC1E73 (option)



AZAI6WSCDKA (option)



BRC2A71 (option)



BRC082A42W (option for white)  
BRC082A42S (option for silver)

INDOOR UNITS

### Flexible Airflow Patterns

The four air louvers in the unit enables comfortable space environment in many different room layouts.

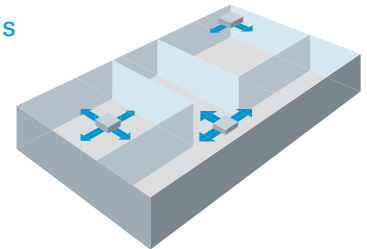

### Applications

- » Retail
- » Schools
- » Offices

### Airflow Angles

**Auto Swing:** Wide discharge angle: 0° to 60°

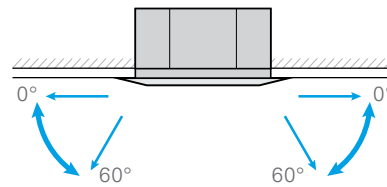

**Fixed Angles:** 5 Levels

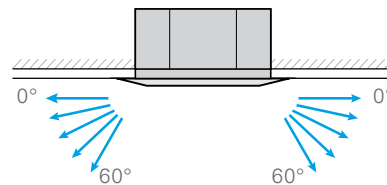

Angles can be also set on site to prevent drafts (0°-35°) or soiling of the ceiling (25°-60°), other than standard setting (0°-60°).



SPECIFICATIONS		0.5 TON	0.6 TON	0.75 TON	1 TON	1.25 TON	1.5 TON	
Model Name		FXZQ05TAVJU	FXZQ07TAVJU	FXZQ09TAVJU	FXZQ12TAVJU	FXZQ15TAVJU	FXZQ18TAVJU	
Capacity Index		5.8	7.5	9.5	12	15	18	
Power Supply		208/230VAC, 60Hz, 1 phase						
Nominal Cooling Capacity*1		Btu/h (kW)	5,800 (1.7)	7,500 (2.2)	9,500 (2.8)	12,000 (3.5)	15,000 (4.5)	
Nominal Heating Capacity*2		Btu/h (kW)	6,500 (1.9)	8,500 (2.5)	10,500 (3.1)	13,500 (4.0)	17,000 (5.0)	
Fan	Type	Turbo Fan						
	Motor Output	W						
	Air Flow Rate (H/M/L)	CFM	300 / 247 / 229	307 / 264 / 229	317 / 282 / 229	353 / 300 / 247	405 / 335 / 282	511 / 441 / 353
	Drive Type	DC Direct Drive						
Dimensions - Unit Body (H x W x D)		in. (mm)	10-1/4 x 22-5/8 x 22-5/8 (260x575x575)					
Dimensions - Decoration Panel (H x W x D)		in. (mm)	1-13/16 x 24-7/16 x 24-7/16 (46x620x620)					
Weight (net)		lb. (kg)	40.4 (18.3)		42.6 (19.3)		47 (21.3)	
Condensate Pump Lift		in. (mm)	24-15/16 (630)					
Sound Pressure Level (H/M/L speed)		dB(A)	32 / 29.5 / 25.5		33 / 30 / 29.5	33.5 / 30 / 26	37 / 32 / 28	
Pipe Connections	Liquid	in.	1/4 (Flare)					
	Gas	in.	1/2 (Flare)					
	Condensate Drain	in.	VP20					
Refrigerant Control		Electronic Expansion Valve						
Maximum Overcurrent Protection Device		A	15					
Minimum Circuit Ampacity		A	0.3		0.4		0.6	
Decoration Panel – White		BYFQ60C3W1W						
Decoration Panel – Silver/White		BYFQ60C3W1S						

**Note:** \*1 Nominal cooling capacities are based on the following conditions: 80 °FDB / 67 °FWB (26.7 °CDB / 19.4 °CWB) return air temperature; 95 °FDB (35 °CDB) outdoor temperature; 25 ft. (7.6 m) equivalent refrigerant piping.

\*2 Nominal heating capacities are based on the following conditions: 70 °FDB (21.1 °CDB) return air temperature; 47 °FDB / 43 °FWB (8.3 °CDB / 6.1 °CWB) outdoor temperature; 25 ft. (7.6 m) equivalent refrigerant piping.

FXZQ_TAVJU ACCESSORIES						
Model Name	FXZQ05TAVJU	FXZQ07TAVJU	FXZQ09TAVJU	FXZQ12TAVJU	FXZQ15TAVJU	FXZQ18TAVJU
Navigation™ Remote Controller*	BRC1E73					
DKN Cloud Wi-Fi Adaptor	AZAI6WSCDKA					
Simplified Wired Remote Controller*	BRC2A71					
Infrared Remote Controller - White**	BRC082A42W					
Infrared Remote Controller - Silver**	BRC082A42S					
Space and Presence Sensor Kit - White**	BRYQ60A2W					
Space and Presence Sensor Kit - Silver**	BRYQ60A2S					
VISTA Decoration Panel - White	BYFQ60C3W1W					
VISTA Decoration Panel - Silver	BYFQ60C3W1S					
Legacy MVJU9-style Decoration Panel	BYFQ60B3W1					
Remote Sensor Kit	KRCS01-4B					
Wiring Adaptor PCB (interface with aux heater, humidifier, OA damper/fan)	KRC1C75					
Long-Life Replacement Filter	KAFQ441BA60					
Sealing Member of Air Discharge Kit	BDBH044C60					
Fresh Air Intake Kit	KDDQ44XA60					

\*Optional face plates to provide a more intuitive user interface and disable specific functions

\*\*Not compatible with the legacy-style decoration panel

**FXZQ\_TAVJU-MVJU9 INSTALLATION SPACE**

MODEL	HEIGHT
FXZQ05-18TAVJU	11.75" or more

\*Leave 7-7/8" or more space on sides where the air outlet is closed.

# FXEQ\_PVJU

## Ceiling-Mounted Cassette (Single Flow)



Condensate Pump as Standard



Outside Air Integration Possible



Filter Included

### Slim and Compact Design for Installation Flexibility

#### Features and Benefits

- » The main body of the unit is optimized to be a compact design. Only 7-7/8" in height and a width of 18-1/2" making it possible to use this style of indoor unit in the tightest of spaces.

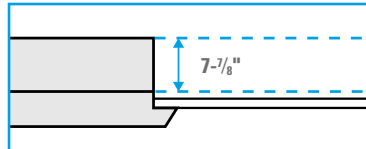

- » The innovative discharge air louver design forces air in heating mode to ground level to improve the overall space heating effect of the indoor unit.

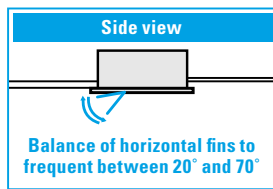
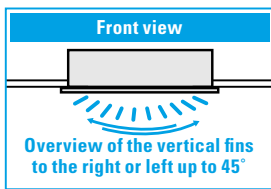

- » The unit is equipped with both horizontal and vertical louvers that can be freely adjusted with the remote controller providing a capability to optimize the airflow and throw to suit your room design.
- » The utilization of both a DC-style Fan Motor and integrated Condensate Pump allow for improvements in energy consumption as well as lower operating sound levels than other styles of indoor units.
- » This Indoor unit can be set to 5 predetermined fan speeds using the BRC1E73 wired remote controller, which allows for optimum and comfortable airflow.



- » A Ventilation Air knock-out is provided to allow up to 15% of the rated airflow through the unit to be pretreated outside air.
- » The innovative "smooth finish" decoration panel design helps to minimize dust and dirt build-up and facilitates easier cleaning.

- » The Indoor Unit is equipped with a factory installed condensate pump with a lift capacity of up to 33-7/16" (measured from the bottom of the unit).



- » The units are equipped with customizable auxiliary heat control settings to facilitate the On/Off control of an external auxiliary heat solution.
- » For ease of service and maintenance activities, it is possible to access the main components of the unit by only removing the decoration panel.

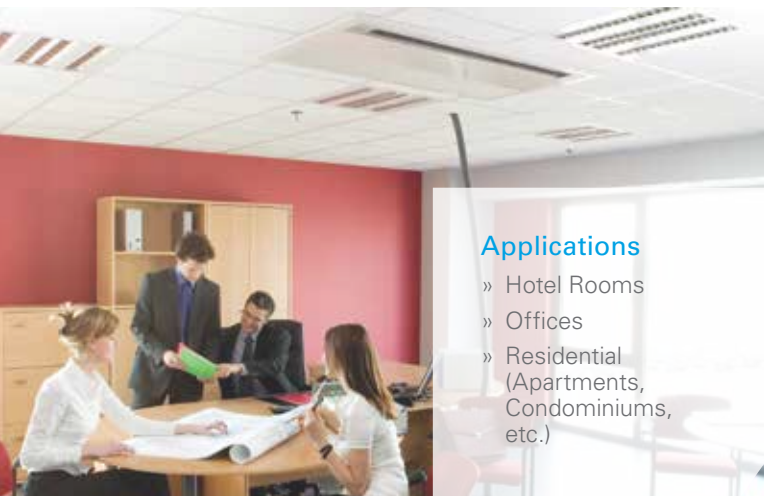
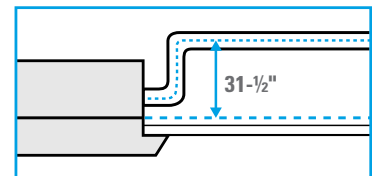

#### Applications

- » Hotel Rooms
- » Offices
- » Residential (Apartments, Condominiums, etc.)

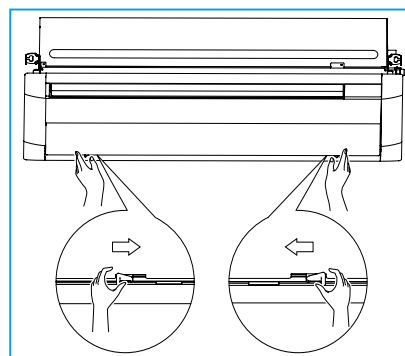

FXEQ_PVJU SPECIFICATIONS			0.6 TON	0.75 TON	1.0 TON	1.25 TON	1.5 TON	2 TON		
Model			FXEQ07PVJU	FXEQ09PVJU	FXEQ12PVJU	FXEQ15PVJU	FXEQ18PVJU	FXEQ24PVJU		
Power Supply			1 phase 60Hz 208/230V							
Cooling capacity	*1,*3	Btu/h	7500	9500	12000	15000	18000	24000		
Heating capacity	*2,*3	Btu/h	8500	10500	13500	17000	20000	27000		
Electrical	Min. circuit amps (MCA)	A	0.3	0.4	0.4	0.5	0.5	0.7		
	Max. overcurrent protection (MOP)	A	15	15	15	15	15	15		
Casing/color			Galvanized steel plate							
Dimensions: (H x W x D)			7-7/8 x 18-1/2 x 33-1-1/16				7-7/8 x 18-1/2 x 48-13/16			
Fan	Type		Sirocco fan							
	Air flow rate (Dry coil)	Cooling (H/HM/M/ML/L)	CFM	212/191/173/155/141	244/226/205/187/170	283/265/247/223/194	346/311/276/247/219	441/403/367/336/307	530/481/431/389/346	
	Drive		Direct drive							
Sound pressure level	Cooling (H/HM/M/ML/L)	dBA	30/29/28/27/26	32/31/30/29/28	35/34/33/32/30	38/37/35/33/31	38/37/35/33/31	43/41/39/37/35		
Weight			38			40		51		
Piping connections	Liquid	in.	ø 1/4 (flare connection)					ø 3/8 (flare connection)		
	Gas	in.	ø 1/2 (flare connection)					ø 5/8 (flare connection)		
	Drain	in.	PVC26 (O.D. 1-1/32 x I.D. 13/16)							
Drain pump lift		in.	25							
Refrigerant control			Electronic expansion valve							
Connectable outdoor unit			R-410A V/RV Series							
Decoration panel (required option)	Model		BYEP40AW1				BYEP63AW1			
	Color		Fresh White							
	Dimensions (H x W x D)		in.	3-3/16 x 21-5/8 x 37-13/32				3-3/16 x 21-5/8 x 53-5/32		
	Air filter		Resin net (with mold resistant)							
	Weight		lbs.	17.6				22		

**Note:** \*1. Nominal cooling capacities are based on the following conditions: return air temperature: 80.0° FDB (26.7° C DB), 67.0° FWB (19.4° CWB), outdoor temperature: 95.0° FDB (35.° C DB) equivalent ref. piping: 25ft. (7.6m) (Horizontal)  
 \*2. Nominal heating capacities are based on the following conditions: return air temperature: 70.0° FDB (21.1° C DB), outdoor temperature: 47.0° FDB (8.3° C DB), 43.0° FDB (6.1° C WB) equivalent ref. piping: 25ft. (7.6m) (Horizontal)  
 \*3. Capacities are net, including a deduction for cooling (an addition for heating) for indoor fan motor heat.

FXEQ_PVJU ACCESSORIES			FXEQ07PVJU	FXEQ09PVJU	FXEQ12PVJU	FXEQ15PVJU	FXEQ18PVJU	FXEQ24PVJU	
Name of Option	Note								
Decoration panel			BYEP40AW1				BYEP63AW1		
Wired remote controller			BRC1E73						
Simplified remote controller			BRC2A71						
Remote sensor			KRCS01-4B						
Wiring adaptor printed circuit board	2		KRP1C75						
Group control adaptor printed circuit board	2		KRP4A74						
Adaptor mounting box			KRP1B101						

**Note:** \*1. Electrical box (No.5-1/6-1) is required for controller (No. 5/6) \*2. Adaptor mounting box (No.12) is necessary.

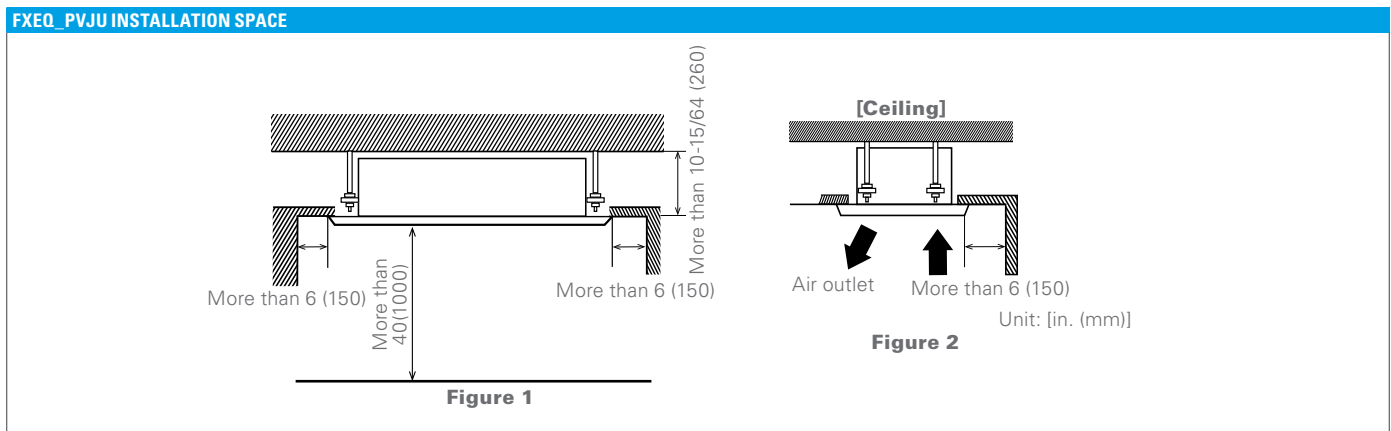



Optional  
Condensate Pump



Filter  
Included

**Slim, Efficient, Quiet, Easy to Maintain**

With its slim, elegant design, the FXHQ ceiling-suspended unit is a great fit for any light commercial space. Wide air openings provide a comfortable airflow and an innovative stream fan ensures quiet operation, making it ideal for retail stores, restaurants, classrooms and conference rooms.

**Features and Benefits**

- » One of our slimmest indoor units (less than 8" ) fits within any interior design
- » Wide air discharge outlet distributes a comfortable airflow throughout the entire space with throw of up to 25 ft.
- » Innovative stream fan technology keeps sound pressure levels low
- » Smooth flat louver design makes cleaning simple
- » Long-life filter is standard
- » Models range from 12 MBH to 36 MBH



BRC1E73  
(option)



AZAI6WSCDKA  
(option)



BRC2A71  
(option)



BRC4C82  
(option)

Quiet Stream Fan (side view)

Uses the quiet stream fan and many more advanced technologies.

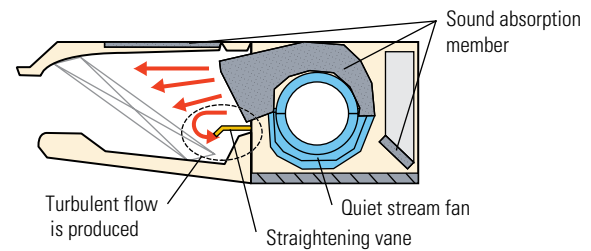

**Applications**

- » Retail/shops
- » Offices
- » Restaurants



FXHQ_MVJU SPECIFICATIONS		1 TON	2 TON	3 TON
Model Name		FXHQ12MVJU	FXHQ24MVJU	FXHQ36MVJU
Power Supply	V/ph/Hz	208-230/1/60		
Rated Cooling Capacity	BTU/h	12,000	24,000	36,000
Rated Heating Capacity	BTU/h	13,500	27,000	40,000
Airflow Rate (H/L)	CFM	410/340	710/600	830/670
Weight	lbs.	55	80	90
Height	in.	7-11/16		
Width	in.	37-13/16	55-1/8	62-5/8
Depth	in.	26-3/4		
Sound Pressure (H/L)	dB(A)	42/33	44/36	46/41
Condensate Pipe Connection	in. O.D.	1		
Pipe Connections	Gas	1/2 (Flare)	5/8 (Flare)	
	Liquid	1/4 (Flare)	3/8 (Flare)	
Refrigerant		R-410A		
Refrigerant Control		Electronic Expansion Valve		
Maximum Overcurrent Protective Device	A	15		
Minimum Circuit Amps	A	0.8	1.0	1.4
Protection Devices		Fuse and Fan Motor Thermal Protector		
External Finish		White Casing		
Standard Filter Type		Resin Net (with Mold Resistant)		

**Nominal Conditions:**

**Cooling Mode**

Indoor: 80 °F DB / 67 °F WB  
 Outdoor: 95 °F DB  
 Pipe Length: 25 ft.  
 Level Difference: 0 ft.

**Heating Mode**

Indoor: 70 °F DB  
 Outdoor: 47 °F DB / 43 °F WB  
 Pipe Length: 25 ft.  
 Level Difference: 0 ft.

Note: Specifications are subject to change without notice.

FXHQ_MVJU ACCESSORIES			
Model Name	FXHQ12MVJU	FXHQ24MVJU	FXHQ36MVJU
Navigation™ Remote Controller*		BRC1E73	
DKN Cloud Wi-Fi Adaptor		AZA16WSDKA	
Simplified Wired Remote Controller*		BRC2A71	
Wireless Remote Controller		BRC7E83	
Remote Sensor Kit		KRCS01-1B	
Wiring Adaptor PCB (interface with aux/primary heater, humidifier, OA damper/fan)		KRP1C74	
Group Control Adaptor PCB (connects to external BMS)		KRP4A72	
Replacement long-life filter	KAFJ501D56	KAFJ501D112	KAFJ501D160
Condensate Pump		DACA-CP3-1	

\* Optional face plates available to provide a more intuitive user interface and disable specific functions

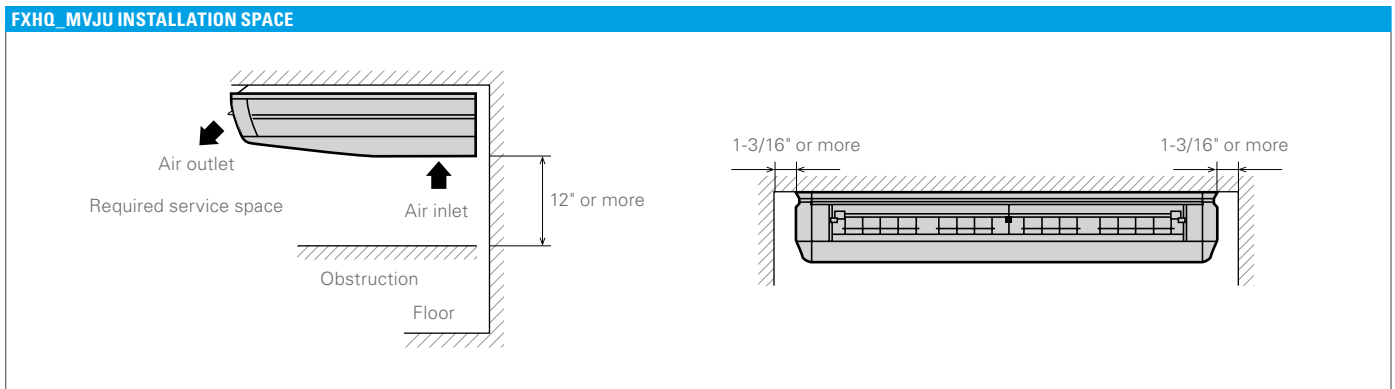

INDOOR UNITS



Optional  
Condensate Pump



Filter  
Included

### Stylish, Compact, Convenient, Comfortable

Daikin's wall-mounted units are ideal for cooling or heating smaller zones such as stores, offices, and restaurants. The compact, stylish design lets the unit blend discreetly into any interior design, and airflow can be supplied in any of five different directions and easily programmed via remote control.



### Features and Benefits

- » Auto-swing mechanism ensures efficient air distribution via louvers that automatically close when the unit is turned off
- » Wide air discharge outlet distributes a comfortable airflow throughout the entire space
- » Horizontal louvers and front panel can be easily removed for cleaning
- » Drain pipe can be easily hidden from sight
- » Models range from 7.5 MBH to 24 MBH



BRC1E73  
(option)



AZAI6WSCDKA  
(option)



BRC2A71  
(option)



BRC4C82  
(option)

### Applications

- » Retail
- » Restaurants
- » Offices
- » Hotels
- » Multi-family residences



FXAQ_PVJU SPECIFICATIONS		0.6 TON	0.75 TON	1 TON	1.5 TON	2 TON
Model Name		FXAQ07PVJU	FXAQ09PVJU	FXAQ12PVJU	FXAQ18PVJU	FXAQ24PVJU
Power Supply	V/ph/Hz	208-230/1/60				
Rated Cooling Capacity	BTU/h	7,500	9,500	12,000	18,000	24,000
Rated Heating Capacity	BTU/h	8,500	10,500	13,500	20,000	27,000
Airflow Rate (H/L)	CFM	260/160	280/175	290/180	500/400	635/470
Weight	lbs.	26				
Height	in.	11-3/8				
Width	in.	31-1/4			41-3/8	
Depth	in.	9				
Sound Pressure (H/L)	dB(A)	36/31	37/31	38/31	43/37	47/41
Condensate Pipe Connection	in. O.D.	11/16				
Pipe Connections	Gas	1/2 (Flare)				5/8 (Flare)
	Liquid	1/4 (Flare)				3/8 (Flare)
Refrigerant		R-410A				
Refrigerant Control		Electronic Expansion Valve				
Maximum Overcurrent Protective Device	A	15				
Minimum Circuit Amps	A	0.4		0.5		0.6
Protection Devices		Fuse and Fan Motor Thermal Protector				
External Finish		White Casing				
Standard Filter Type		Resin Net (washable)				

**Nominal Conditions:**

**Cooling Mode**

Indoor: 80 °F DB / 67 °F WB  
 Outdoor: 95 °F DB  
 Pipe Length: 25 ft.  
 Level Difference: 0 ft.

**Heating Mode**

Indoor: 70 °F DB  
 Outdoor: 47 °F DB / 43 °F WB  
 Pipe Length: 25 ft.  
 Level Difference: 0 ft.

Note: Specifications are subject to change without notice.

**FXAQ\_PVJU ACCESSORIES**

Model Name	FXAQ07PVJU	FXAQ09PVJU	FXAQ12PVJU	FXAQ18PVJU	FXAQ24PVJU
Navigation™ Remote Controller*			BRC1E73		
DKN Cloud Wi-Fi Adaptor			AZA16WSCDKA		
Simplified Wired Remote Controller*			BRC2A71		
Wireless Remote Controller			BRC7E818		
Remote Sensor Kit			KRCS01-1B		
Group Control Adaptor PCB (Connects to external BMS)			KRP4A71		
Condensate Pump			DACA-CP1-1		

\* Optional face plates available to provide a more intuitive user interface and disable specific functions

**FXAQ\_PVJU INSTALLATION SPACE**

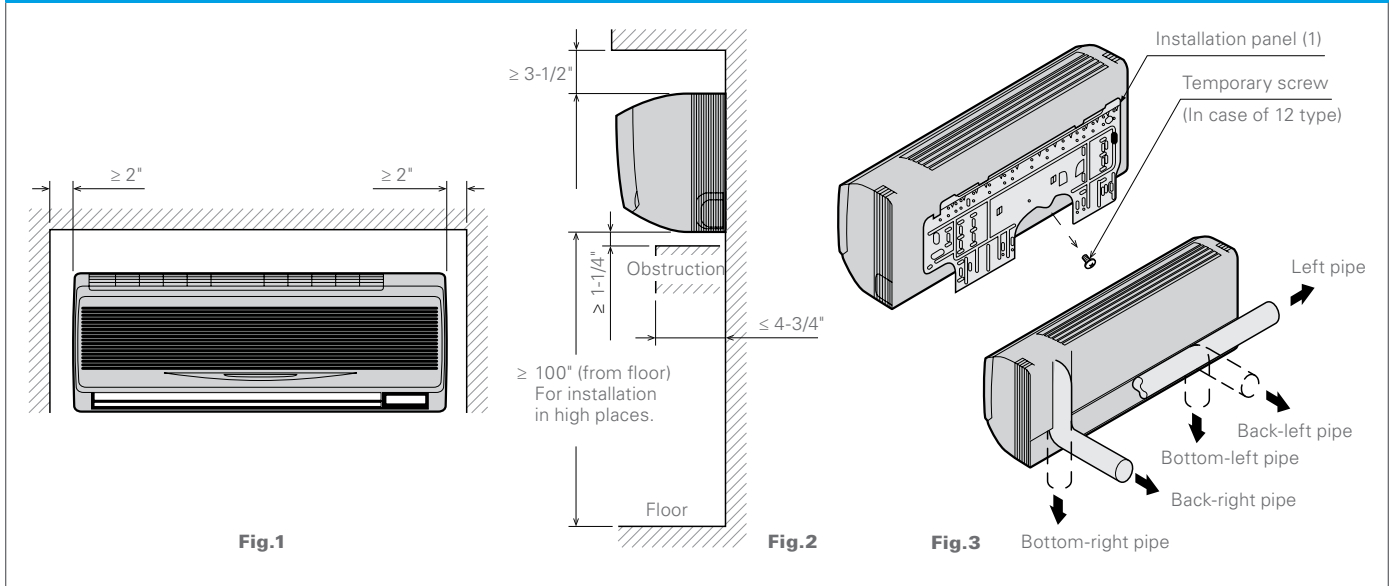

INDOOR UNITS

# FXLQ\_MVJU9 Floor-Standing Unit



Outside Air  
Integration Possible

Filter  
Included

## Versatile, Logical, Durable, Quiet

The ideal way to save space, our floor-standing units can easily be installed along a perimeter wall. The air distribution from these models will allow you to find the right balance for classrooms, churches, office hallways or similar spaces.

### Features and Benefits

- » Ideal for installation beneath a window
- » Unit requires minimal installation space
- » Fitted with a washable long-life filter
- » Remote-control options available
- » Space-saving unit can be freestanding or wall-mounted
- » Models range from 7.5 MBH to 24 MBH



BRC1E73  
(option)



AZAI6WSCDKA  
(option)



BRC2A71  
(option)



BRC4C82  
(option)

### Applications

- » Multi-family residences
- » Single-family residences
- » Churches
- » Historic buildings
- » Schools
- » Offices





FXLQ_MVJU9 SPECIFICATIONS			0.6 TON	0.75 TON	1 TON	1.5 TON	2 TON
Model Name			FXLQ07MVJU9	FXLQ09MVJU9	FXLQ12MVJU9	FXLQ18MVJU9	FXLQ24MVJU9
Power Supply	V/ph/Hz	208-230/1/60					
Rated Cooling Capacity	BTU/h	7,500	9,500	12,000	18,000	24,000	
Rated Heating Capacity	BTU/h	8,500	10,500	13,500	20,000	27,000	
Airflow Rate (H/L)	CFM	245/210		280/210	490/380		560/420
Weight	lbs.	58		66	80		
Height	in.				23-5/8		
Width	in.	39-3/8			44-7/8	55-7/8	
Depth	in.				8-3/4		
Sound Pressure (H/L)	dB(A)	35/32			36/33	40/35	41/36
Condensate Pipe Connection	in. O.D.				27/32		
Pipe Connections	Gas	in.	1/2 (Flare)				5/8 (Flare)
	Liquid	in.	1/4 (Flare)				3/8 (Flare)
Refrigerant		R-410A					
Refrigerant Control		Electronic Expansion Valve					
Maximum Overcurrent Protective Device	A				15		
Minimum Circuit Amps	A	0.3			0.5	0.6	
Protection Devices		Fuse and Fan Motor Thermal Protector					
External Finish		Ivory White Casing					
Standard Filter Type		Resin Net (with Mold Resistant)					

**Nominal Conditions:**

**Cooling Mode**

Indoor: 80 °F DB / 67 °F WB  
 Outdoor: 95 °F DB  
 Pipe Length: 25 ft.  
 Level Difference: 0 ft.

**Heating Mode**

Indoor: 70 °F DB  
 Outdoor: 47 °F DB / 43 °F WB  
 Pipe Length: 25 ft.  
 Level Difference: 0 ft.

Note: Specifications are subject to change without notice.

**FXLQ\_MVJU9 ACCESSORIES**

Model Name	FXLQ12MVJU9	FXLQ18MVJU9	FXLQ24MVJU9	FXNQ12MVJU9	FXNQ18MVJU9	FXNQ24MVJU9
Navigation™ Remote Controller*				BRC1E73		
DKN Cloud Wi-Fi Adaptor				AZA16WSCDKA		
Simplified Wired Remote Controller*				BRC2A71		
Wireless Remote Controller				BRC4C82		
Remote Sensor Kit				KRCS01-1B		
Wiring Adaptor PCB (interface with aux/primary heater, humidifier, OA damper/fan)				KRP1C74		
Group Control Adaptor PCB (connects to external BMS)				KRP4A71		

\* Optional face plates available to provide a more intuitive user interface and disable specific functions

**FXLQ\_MVJU9 INSTALLATION SPACE**

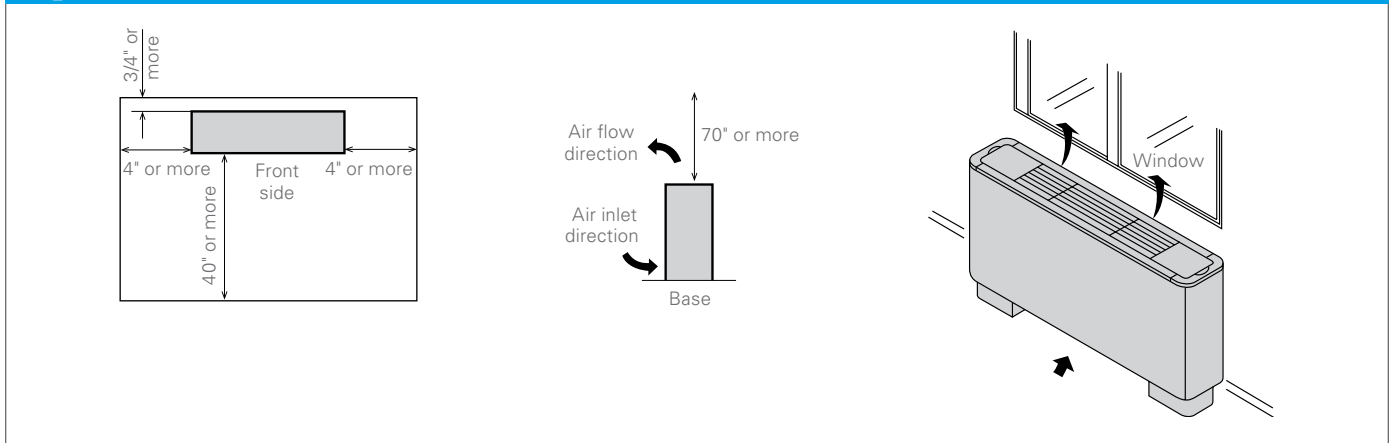

Kits and Accessories



The optional Daikin Zoning Kit (DZK) increases the flexibility of the Daikin VRV systems by adding a Zoning Box to an indoor unit fan coil, allowing several separate ducts to supply air to different individually-controlled zones in the building. A zone can be a room, part of room, or several rooms. This flexible and scalable Zoning Kit integrates seamlessly with the indoor unit fan coil controls. The DZK system controls work together with the regular Daikin zone controller (i.e. BRC1E73) to establish the required set-point, fan speed and mode of operation that is then requested to the VRV indoor unit via the Daikin zone controller. This allows the internal DZK control algorithms to look at the number of zone dampers in operation, and at what position the dampers need to be and adjust the VRV indoor unit operation accordingly. The DZK system is not directly compatible with the suite of Daikin centralized control options such as iTM™ and iTCT™.

A complete Daikin Zoning Kit consists of Zoning Box (with Control Board), Wired Thermostat, and Wireless Thermostats. The optional DZK BACnet Interface enables any BACnet/IP compatible Building Management System to be used for remote monitoring and control of the DZK.

Wired Thermostat

The 3rd generation DZK introduces all new, redesigned Wired and Wireless thermostats. The revised form factor offers a slim profile and capacitive touch capability for an enhanced user experience.



The wired thermostat in the DZK is a graphical colored, touch-screen interface with text menus, intuitive icons, and guided scheduling capability. It displays temperatures and operating values, and selects the operating mode for the system.

Wireless Thermostats

The optional Wireless thermostat offers a backlit, low energy E Ink display with capacitive touch buttons. The user can adjust the zone set point temperature, set user mode schedules, activate local ventilation, and more.



The optional Wireless Lite thermostat offers a sleek, simple user interface to adjust the local zone set point temperature using led-lit capacitive touch buttons.

Now with BACnet®/IP compatibility

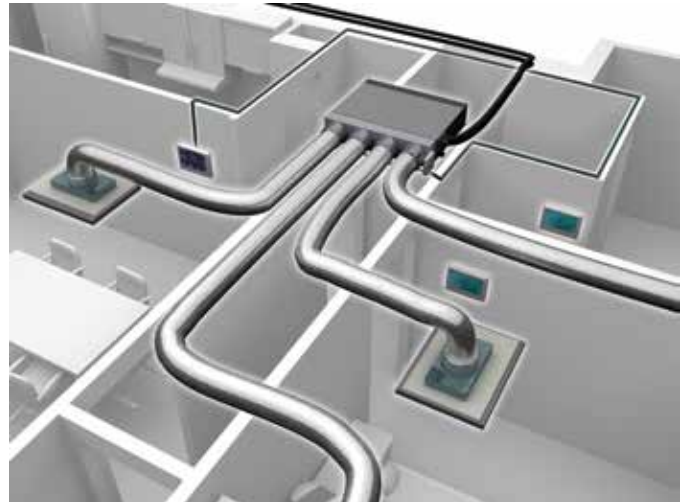

Zoning Box with Control Box (Model Depends on Indoor Unit)

The Zoning Box in the Daikin Zoning Kit mounts easily on Daikin's Indoor Unit FXMQ-P or FXSQ series fan coils. It consists of the enclosure, individually motorized dampers, and a control box. It is available in different sizes and damper configurations and by utilizing ducts for air supply it can be used to control the air temperature in up to 6 zones. The wired thermostat and the wireless thermostats provide temperature inputs and user interfaces for programming and adjustment of the control functions for each zone.



DZK BACnet Interface

If VRV systems are installed with the DZK system to accomplish a variety of zoning solutions and there is a requirement to be able to monitor and control the various DZK zone dampers from a centralized control system, it is possible to utilize the DZK BACnet Interface to address this solution.



The DZK BACnet Interface will work with any BACnet/IP compatible Building Management System.

DAIKIN ZONING KIT (DZK) - GENERAL TECHNICAL DATA											
DZK Model		DZKS015E3-3	DZKS015E4-3	DZKS030E4-3	DZKS030E5-3	DZKS048E4-3	DZKS048E6-3	DZK030E4-3	DZK030E5-3	DZK048E4-3	DZK048E6-3
Height	in.	9-5/8	9-5/16	9-5/8	9-5/16	9-5/8	9-5/16	10-7/16	10-1/4	10-7/16	10-1/4
Width	in.	34-3/16		43-5/8		53-7/16		43-9/16		53-7/16	
Depth	in.	10-7/16									
Weight	lb.	16	18	18	20	18	23	18	20	20	23
No. of Zones		3	4	4	5	4	6	4	5	4	6
Ø of Outlets	in.	8	6	8	6	8	6	8	6	8	6
Power Supply	VAC	110/230 VAC									
	ph	1									
	Hz	60									

DAIKIN ZONING KIT (DZK) - COMPATIBILITY											
VRV Indoor Unit	DZKS015E4-3	DZKS015E4-3	DZKS030E4-3	DZKS030E5-3	DZKS048E4-3	DZKS048E6-3	DZK030E4-3	DZK030E5-3	DZK048E4-3	DZK048E6-3	
FXSQ15TAVJU	■	■									
FXSQ18/24/30TAVJU			■	■							
FXSQ36/48TAVJU					■	■					
FXMQ15/18/24PBVJU							■	■			
FXMQ30/36/48/54PBVJU									■	■	
DZK-MTS-3-W*	■	■	■	■	■	■	■	■	■	■	
DZK-ZTS-3-W	■	■	■	■	■	■	■	■	■	■	
DZK-LTS-3-W	■	■	■	■	■	■	■	■	■	■	
DZK-BACNET-3	■	■	■	■	■	■	■	■	■	■	

\*Minimum (1) required per DZK Zoning Kit

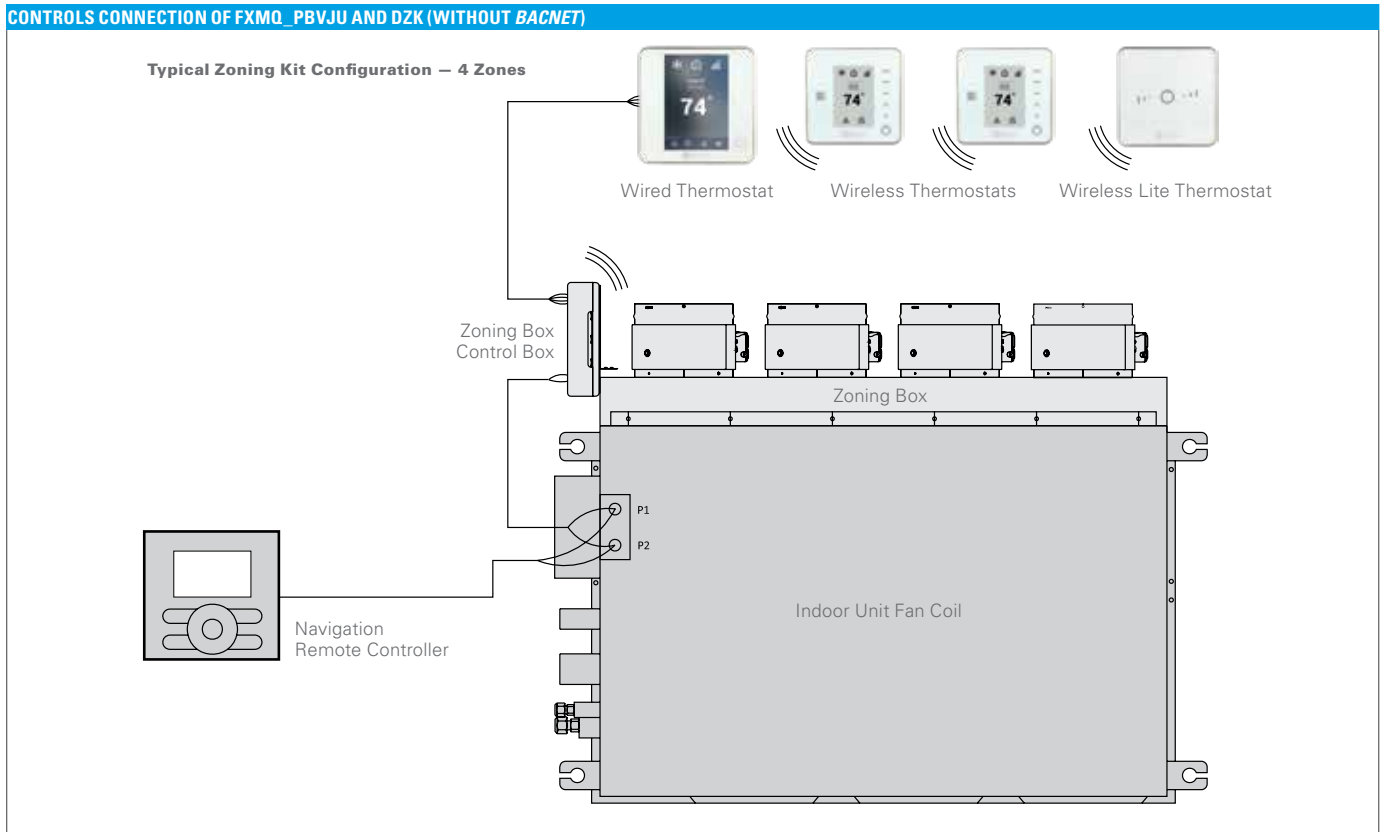

INDOOR UNITS



# Outdoor Units



## Air-Cooled Condensers

### VRV IV X

#### VRV IV X Heat Recovery

6 to 38 Tons 208-230V/60Hz/3ph or 460V/60Hz/3ph

Engineered and assembled in North America Daikin's VRV IV X adapts VRV to North American HVAC market needs by expanding the applications in which VRV can be leveraged to solve traditional challenges. Packed with advanced technology, VRV IV X is the industry's first 3-phase variable refrigerant flow system with dual-fuel capability, after Daikin's launch of 1-phase VRV LIFE™ in 2018. The new series is equipped with features to optimize initial capital required on phased installations and provides ease of service and maintenance.



### VRV IV S-series

#### Heat Pump

3, 4 and 5 Tons 208-230V/60Hz/1ph

The VRV IV S-series system is a highly efficient solution for light commercial buildings and residential applications requiring heating and cooling of up to 9 zones. Space-saving design to fit in tight areas and realize quick and easy installation. Single-supplier reliability. The system — factory engineered and 80% complete upon delivery — is fully optimized by Daikin.



### VRV

#### VRV AURORA™ Heat Recovery & Heat Pump

6 to 20 Tons 208-230V/60Hz/3ph 460V/60Hz/3ph

Daikin VRV AURORA Series systems introduce a new benchmark for variable refrigerant flow technology by integrating advanced technologies to provide comfort, control, energy efficiency and reliability. The Daikin VRV AURORA Series systems set a new industry standard for heating and cooling solutions by delivering high heat capacities at low ambient applications.



### VRV

#### VRV T-Series Water-Cooled Condensing Unit Heat Pump/Heat Recovery

6+ to 36 Tons 208-230V/60Hz/3ph or 460V/60Hz/3ph

The VRV Water-Cooled system combines the characteristics of a water-cooled system with the air-cooled VRV system and still use the same VRV indoor units, similar refrigerant piping methods, branch selector boxes, and controls as air-cooled VRV systems. The main difference is that heat is rejected or absorbed via the condensing units to and from the 2-pipe water circuit instead of the outside air.



- » variable refrigerant flow Industry's first air-cooled system that delivers heating down to -22°F (-30°C) as standard
- » Hot gas base pan circuit allows installation without an additional drain pan heater
- » Designed to provide continuous heating during defrost and oil return<sup>1</sup>
- » Engineered with Daikin vapor injection compressor for optimized part load efficiencies

- » Flexible System design with increased diversity up to 150%<sup>††</sup>
- » Can be applied to both geothermal and boiler/tower applications as standard with condenser water inlet temperature as low as 14°F<sup>††</sup> in heating and 23°F<sup>††</sup> in cooling is possible
- » Triple-stack capable to deliver up to 36 tons thanks to the compact design
- » Engineered with heat rejection cancellation technology<sup>††</sup> to eliminate mechanical room conditioning requirements
- » 2-9V variable water flow control logic<sup>††</sup> as standard to increase waterside system operational efficiencies
- » Drop-down switch box for easy service to key components
- » Field selectable top or front refrigerant connections for flexible and easy installation

### VRV IV

#### Heat Pump & Heat Recovery

6 to 38<sup>2</sup> Tons 208-230V/60Hz/3ph 460V/60Hz/3ph

Daikin's VRV IV systems integrate advanced technology to provide comfort control to help maximize energy efficiency and reliability. Currently available in heat pump and heat recovery configurations, VRV IV provides a solution for multi-family residential to large commercial applications desiring heating or cooling. The VRV IV is the first variable refrigerant flow system to be assembled in North America.



<sup>1</sup> Multi module heat recovery systems only for continuous heating during defrost

<sup>2</sup> Maximum 34 tons for Heat Pump

<sup>†</sup> 6-ton model (RWEYQ72PC) is PC series. T and PC series models cannot be combined to form multi-module systems.

<sup>††</sup> Conditions/rules apply. Refer to Installation and Engineering Manual for further details.



OUTDOOR UNITS

Local assembly of products enables Daikin to react fast to changes in the marketplace and truly optimize the product for the North American market.

# VRV IV X

## Air-Cooled Heat Recovery

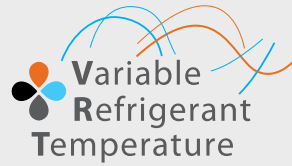

Engineered and assembled in North America, Daikin's VRV IV X adapts VRV to North American HVAC market needs by expanding the applications in which VRV can be leveraged to solve traditional challenges. Packed with advanced technology, VRV IV X is the industry's first 3-phase variable refrigerant flow system with dual-fuel capability, after Daikin's launch of 1-phase VRV LIFE™ in 2018. The new series is equipped with features to optimize initial capital required on phased installations and provides ease of service and maintenance.

### Features and Benefits

- » Adapting VRV to North American market needs
  - Industry's first 3-phase variable refrigerant flow system to integrate with communicating gas furnaces.
  - Design flexibility to enlarge system from single to dual module or dual to triple module without change to installed main pipe sizes<sup>1</sup>.
  - Engineered to optimize capital on phased and tenant fit out commercial buildings.
  - Choice of gas furnace or heat pump heating for optimizing operational costs based on utility cost.
  - Year round comfort and energy savings with Variable Refrigerant Temperature (VRT) technology.
- » Technology that matters
  - Engineered with Daikin's patented vapor injection compressor technology.
  - Corrosion resistant up to 1000<sup>†</sup> hours Daikin Blue Fin coating as factory standard.
  - Heat exchanger engineered with a bottom refrigerant circuit that allows installation without base pan heater.
  - Refrigerant cooled inverter technology keeps PCB cool independent of ambient temperature.
  - Increased<sup>1</sup> applied cooling and heating capacities with improved pipe correction factors (compared to the previous VRV IV generation).
- » Engineered for maintenance
  - New service window provides ease of access to the multi-functional display without removing the main electrical panel. The built-in multi-functional display is utilized for commissioning and maintenance and quickly converts to digital gauges to provide refrigerant pressure and temperatures.
  - Multi-functional display eliminates the need to connect gauges during regular maintenance checks.
  - Ease of commissioning with ability to program off site and upload using configurator tool.

## VRV IV X



- Field performable intermittent outdoor fan operation to help minimize snow accumulation on fan blades when the system is in thermal off.
- Seamless integration with T-series branch selector boxes, M, P, and T-series indoor units.
- Compatible with the full suite of Daikin VRV controls.
- Outstanding 10-Year Parts Warranty\* as standard.

\* Complete commercial warranty details available from your local distributor or manufacturer's representative or at [www.daikincomfort.com](http://www.daikincomfort.com) or [www.daikinac.com](http://www.daikinac.com).

<sup>†</sup> When testing in accordance to ASTM B117 methodology.

<sup>1</sup> Refer to engineering manuals for design rules and pipe sizes.





**VRV IV X CERTIFIED DATA - HEAT RECOVERY, 208-230V/60HZ/3PH, 460V/60HZ/3PH**

Product#	Capacity (Tons)	IEER Non-Ducted	IEER Ducted	IEER Mixed	SCHE Non-Ducted	SCHE Ducted	SCHE Mixed	COP @ 47°F Non-Ducted	COP @ 47°F Ducted	COP @ 47°F Mixed	COP @ 17°F Non-Ducted	COP @ 17°F Ducted	COP @ 17°F Mixed	EER Non-Ducted	EER Ducted	EER Mixed
REYQ72XA	6	25.20	21.30	23.25	26.10	22.00	24.05	4.30	3.68	3.99	2.50	2.25	2.38	15.80	13.90	14.85
REYQ96XA	8	27.80	21.90	24.85	26.40	21.10	23.75	4.23	3.56	3.90	2.63	2.31	2.47	14.60	12.50	13.55
REYQ120XA	10	25.50	22.60	24.05	26.00	22.00	24.00	3.81	3.48	3.65	2.54	2.28	2.41	13.20	12.30	12.75
REYQ144XA	12	23.50	21.60	22.55	25.50	22.00	23.75	3.75	3.42	3.59	2.16	2.12	2.14	11.90	11.60	11.75
REYQ168XA	14	22.30	20.40	21.35	25.50	22.20	23.85	3.49	3.24	3.37	2.08	2.05	2.07	10.70	10.60	10.65
REYQ192XA	16	22.60	21.40	22.00	26.60	22.80	24.70	3.85	3.67	3.76	2.50	2.37	2.44	13.00	13.00	13.00
REYQ216XA	18	23.10	21.70	22.40	25.50	21.90	23.70	3.76	3.52	3.64	2.34	2.20	2.27	12.40	12.30	12.35
REYQ240XA	20	22.20	20.00	21.10	25.60	21.80	23.70	3.68	3.39	3.54	2.34	2.16	2.25	11.60	11.70	11.65
REYQ264XA	22	21.60	18.00	19.80	26.10	18.20	22.15	3.62	3.20	3.41	2.22	2.07	2.15	11.20	10.40	10.80
REYQ288XA	24	21.00	17.90	19.45	23.30	19.90	21.60	3.51	3.20	3.36	2.20	2.06	2.13	11.00	10.30	10.65
REYQ312XA	26	20.40	18.00	19.20	24.30	20.70	22.50	3.56	3.20	3.38	2.09	2.05	2.07	10.10	9.90	10.00
REYQ336XA	28	20.00	17.30	18.65	23.30	19.80	21.55	3.53	3.20	3.37	2.12	2.05	2.09	9.90	9.50	9.70
REYQ360XA	30	20.00	18.80	19.40	23.00	19.40	21.20	3.56	3.20	3.38	2.25	2.10	2.18	10.90	10.60	10.75
REYQ384XA	32	19.00	17.60	18.30	21.90	17.00	19.45	3.21	3.20	3.21	2.22	2.06	2.14	9.70	9.90	9.80
REYQ408XA	34	17.20	17.70	17.45	21.80	18.30	20.05	3.21	3.20	3.21	2.09	2.05	2.07	9.80	9.70	9.75
REYQ432XA	36	16.20	17.30	16.75	20.20	18.10	19.15	3.21	3.20	3.21	2.08	2.06	2.07	9.80	9.70	9.75
REYQ456XA	38	16.20	16.70	16.45	18.80	17.90	18.35	3.21	3.20	3.21	2.07	2.05	2.06	9.30	9.50	9.40

Certified efficiency data in accordance with ANSI/AHRI Standard 1230 2014, "Performance Rating of Variable Refrigerant Flow Multi-Split Air Conditioning and Heat Pump Equipment" for the VRV Series. The VRV IV X Series has been designed and optimized to meet or exceed the latest minimum efficiency requirements in 10 C.F.R. Part 431 as determined by the U.S. Department of Energy (DOE) and baseline efficiencies as defined by ASHRAE 90.1 2016. Systems under 65MBH are currently certified to AHRI 210/240. IEER ratings are as defined in ASHRAE 90.1 2016.

OUTDOOR UNITS

**DETAILED OPERATION RANGES FOR VRV IV X REYQ\_X HEAT RECOVERY OUTDOOR UNITS**

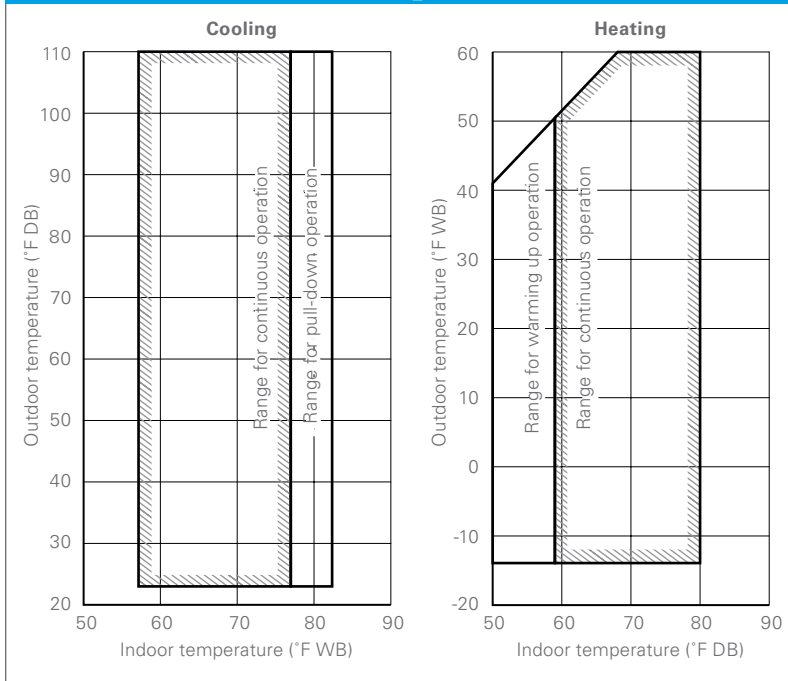

**TECHNICAL COOLING FEATURE FOR VRV IV X REYQ\_X HEAT RECOVERY OUTDOOR UNITS**

Technical Cooling - Cooling operation extended from 23°F ambient air temperature down to -4°.

The Technical Cooling feature is engaged by field settings on the outdoor unit and on branch selector boxes. It requires addition of snow hoods to the unit and allows operation down to -4° FDB ambient temperature in cooling mode.

See the Engineering Data book for complete application rules and contact your local Daikin representative for wind cover specification requirements.

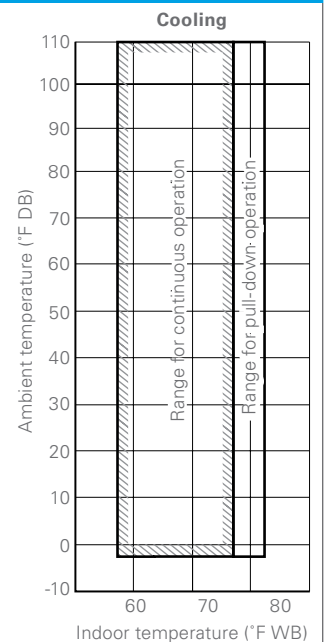

# VRV IV X

## Air-Cooled Heat Recovery (cont.)

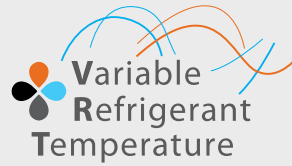

### TECHNICAL DATA FOR VRV IV X-TATJU/TAYDU HEAT RECOVERY OUTDOOR UNITS

		6 Ton	8 Ton	10 Ton	12 Ton	14 Ton	16 Ton	18 Ton	20 Ton		
Model	208-230V/3Ph/60Hz	REYQ72XATJU	REYQ96XATJU	REYQ120XATJU	REYQ144XATJU	REYQ168XATJU	REYQ192XATJU	REYQ216XATJU	REYQ240XATJU		
	460V/3Ph/60Hz	REYQ72XAYDU	REYQ96XAYDU	REYQ120XAYDU	REYQ144XAYDU	REYQ168XAYDU	REYQ192XAYDU	REYQ216XAYDU	REYQ240XAYDU		
	Combination						2 x REYQ96XA	1 x REYQ96XA 1 x REYQ120XA	2 x REYQ120XA		
Performance	Rated Cooling Capacity	BTU/h	69,000	92,000	114,000	138,000	160,000	184,000	206,000	228,000	
	Rated Heating Capacity	BTU/h	77,000	103,000	129,000	154,000	180,000	206,000	232,000	256,000	
	Standard Operation Range Cooling	°F (°C) DB	23 to 122								
	Standard Operation Range Heating	°F (°C) WB	-13 to 60								
	Sound Pressure	dB(A)	65	65	65	66	66	68	68	68	
	Airflow	CFM	7283	7989	7989	9480	9480	7989 + 7989	7989 + 7989	7989 + 7989	
Fan ESP, Standard/Max	in. W.G.	0.12 / 0.32									
Compressor	Compressors, all inverter	Qty	1				2				
	Revolutions per minute	RPM	3738	5142	6888	5214	6330	5214 + 5214	5994 + 5994	6702 + 6702	
	Capacity Control Range	%	15-100	13-100	11-100	14-100	12-100	6-100	6-100	5-100	
Refrigerant Piping, Layout	Maximum Vertical Pipe Length Above Unit	ft.	164 (295 With Field Setting)								
	Maximum Vertical Pipe Length Below Unit	ft.	130 (195 With Field Setting)								
	Maximum Vertical Pipe Length Between IDU	ft.	100								
	Maximum Actual Pipe Length	ft.	541								
	Maximum Equivalent Pipe Length	ft.	620								
Maximum Total Pipe Length	ft.	3,280									
Refrigerant Piping, Connections	Liquid Pipe, Main Line	in.	3/8	3/8	1/2	1/2	5/8	5/8	5/8	5/8	
	Suction Gas Pipe, Main Line	in.	3/4	7/8	1-1/8	1-1/8	1-1/8	1-1/8	1-1/8	1-3/8	
	Discharge Gas Pipe, Main Line	in.	5/8	3/4	3/4	7/8	7/8	1-1/8	1-1/8	1-1/8	
Connection Ratio	Standard Connectable Indoor Unit Ratio	%	70 - 200 <sup>1</sup>		50 - 200 <sup>1</sup>						
	Maximum Number of Indoor Units	Qty	12	16	20	25	29	33	37	41	
Electrical	Maximum Overcurrent Protection, MOP (208-230v/460v)	A	45 / 25	45 / 25	50 / 25	70 / 40	70 / 40	45 + 45 / 25 + 25 /	45 + 50 / 25 + 25 /	50 + 50 / 25 + 25 /	
	Minimum Circuit Amps, MCA (208-230v/460v)	A	38.1 / 18.9	38.1 / 21.1	43.0 / 21.1	58.3 / 27.9	61.9 / 31.1	38.1 + 38.1 / 21.1 + 21.1 /	38.1 + 43.0 / 21.1 + 21.1 /	43.0 + 43.0 / 21.1 + 21.1 /	
	Compressor Rated Load Amps, (208-230v/460v)	A	20.8 / 9.4	23.3 / 10.5	28.2 / 12.8	42.6 / 19.3	49.0 / 22.2	24.7 + 24.7 / 11.2 + 11.2 /	28.5 + 28.5 / 12.9 + 12.9 /	29.0 + 29.0 / 13.5 + 13.5 /	
Unit	Factory Refrigerant Charge	lbs.	25.8				25.8 + 25.8				
	Weight	lbs.	727	727	727	793	793	727 + 727	727 + 727	727 + 727	
	Dimensions (H x W x D)	in.	66-11/16 x 48-7/8 x 30-3/16				66-11/16 x 48-7/8 x 30-3/16 + 66-11/16 x 48-7/8 x 30-3/16				

<sup>1</sup>Varies based on indoor model selected

<sup>2</sup>35.5 ton for REYQ432TAYCU

### OPERATION RANGE FOR ALL VRV IV X HEAT RECOVERY OUTDOOR UNITS

Cooling °F DB	-4* – 122
Heating °F WB	-13 – 60

\*Application rules apply

OUTDOOR UNITS

22 Ton	24 Ton	26 Ton	28 Ton	30 Ton	32 Ton	34 Ton	36 Ton <sup>2</sup>	38 Ton	
REYQ264XATJU	REYQ288XATJU	REYQ312XATJU	REYQ336XATJU	REYQ360XATJU	REYQ384XATJU	REYQ408XATJU	REYQ432XATJU	REYQ456XATJU	
REYQ264XAYDU	REYQ288XAYDU	REYQ312XAYDU	REYQ336XAYDU	REYQ360XAYDU	REYQ384XAYDU	REYQ408XAYDU	REYQ432XAYDU	REYQ456XAYDU	
1 x REYQ120XA 1 x REYQ144XA	2 x REYQ144XA	1 x REYQ144A 1 x REYQ168XA	2 x REYQ168XA	3 x REYQ120XA	2 x REYQ120XA 1 x REYQ144XA	1 x REYQ120XA 2 x REYQ144XA	3 x REYQ144XA	2 x REYQ144XA 1 x REYQ168XA	
252,000	274,000	296,000	320,000	342,000	364,000	388,000	410,000	430,000	
282,000	294,000	320,000	338,000	376,000	386,000	394,000	405,000	414,000	
23 to 122									
-13 to 60									
69	69	69	69	70	71	71	71	71	
7989 + 9480	9480 + 9480	9480 + 9480	9480 + 9480	7989 + 7989 + 7989	7989 + 7989 + 9480	7989 + 9480 + 9480	9480 + 9480 + 9480	9480 + 9480 + 9480	
0.12 / 0.32									
2					3				
6504 + 5214	4794 + 4794	5286 + 5286	5664 + 5664	6606 + 6606 + 6606	6426 + 6426 + 5070	6162 + 4470 + 4470	4350 + 4350 + 4350	4470 + 4470 + 4470	
5-100	7-100	7-100	6-100	4-100	3-100	3-100	5-100	4-100	
164 (295 With Field Setting)									
130 (195 With Field Setting)									
100									
541									
620									
3,280									
3/4	3/4	3/4	3/4	3/4	3/4	3/4	3/4	3/4	
1-3/8	1-3/8	1-3/8	1-3/8	1-5/8	1-5/8	1-5/8	1-5/8	1-5/8	
1-1/8	1-1/8	1-1/8	1-1/8	1-3/8	1-3/8	1-3/8	1-3/8	1-3/8	
50 - 200'									
45	49	54	58	64					
50 + 70 / 25 + 40	70 + 70 / 40 + 40	70 + 70 / 40 + 40	70 + 70 / 40 + 40	50 + 50 + 50 / 25 + 25 + 25	50 + 50 + 70 / 25 + 25 + 40	50 + 70 + 70 / 25 + 40 + 40	70 + 70 + 70 / 40 + 40 + 40	70 + 70 + 70 / 40 + 40 + 40	
43.0+58.3 / 21.1 + 27.9	58.3+58.3 / 27.9 + 27.9	58.3+61.9 / 27.9 + 31.1	61.9+61.9 / 31.1 + 31.1	43.0+ 43.0 + 43.0 / 21.1 + 21.1 + 21.1	43.0+ 43.0 + 58.3 / 21.1 + 21.1 + 27.9	43.0 + 58.3 + 58.3 / 21.1 + 27.9 + 27.9	58.3 + 58.3 + 58.3 / 27.9 + 27.9 + 27.9	58.3 + 58.3 + 61.9 / 27.9 + 27.9 + 31.1 /	
32.9 + 42.1 / 14.9 + 19.0	43.5 + 43.5 / 19.7 + 19.7	46.5 + 46.5 / 21.0 + 21.0	50.1 + 50.1 / 22.7 + 22.7	32.7 + 32.7 + 32.7 / 14.8 + 14.8 + 14.8	33.8 + 33.8 + 43.7 / 15.3 + 15.3 + 19.8	35.7 + 45.1 + 45.1 / 16.2 + 20.4 + 20.4	45.1 + 45.1 + 45.1 / 20.4 + 20.4 + 20.4	47.0 + 47.0 + 47.0 / 21.3 + 21.3 + 21.3	
25.8 + 25.8					25.8 + 25.8 + 25.8				
727 + 793	793 + 793	793 + 793	793 + 793	727 + 727 + 727	727 + 727 + 793	727 + 793 + 793	793 + 793 + 793	793 + 793 + 793	
66-11/16 x 48-7/8 x 30-3/16 + 66-11/16 x 48-7/8 x 30-3/16					66-11/16 x 48-7/8 x 30-3/16 + 66-11/16 x 48-7/8 x 30-3/16 + 66-11/16 x 48-7/8 x 30-3/16				

OUTDOOR UNITS

For additional technical information please refer to specific Engineering Data Books.

## VRV IV X

# Indoor Units 80-97% AFUE Communicating Gas Furnace

### Features

- » **Compatible with VRV IV X outdoor units.** Available from 60,000 Btu up to 120,000 Btu
- » **Durable heat exchanger** – Unique tubular stainless-steel construction formed using wrinkle-bend technology results in an extremely durable heat exchanger. Paired with a stainless-steel secondary heat exchanger, this combination provides for reliability, durability and efficiency.
- » **Modulating gas valve** – Operates between 35% - 100% capacity, providing precise efficiency and the ultimate in comfort.
- » **Continuous air circulation** – Provides filtration and keeps air moving throughout your home to help maintain comfort.
- » **Self-diagnostic control board** – continuously monitors the system for consistent, reliable operation.
- » **Quiet, variable-speed induced draft blower** – provides precise control and enhanced energy-efficient performance as compared to single-speed blowers.



COMFORTABLE LIMITED WARRANTY\* PROTECTION



\* Complete commercial warranty details available from your local dealer/contractor or at [www.daikincomfort.com](http://www.daikincomfort.com). To receive the 10-Year Parts Limited Warranties, online registration must be completed within 60 days of installation. Online registration and some of the additional requirements are not required in California or Quebec.

VRV IV X  
VRV A-Coil  
CXTQ\_TASBLU



CXTQ All Aluminum Coil

- » Available in 2, 3, 4, and 5-Ton capacities
- » Engineered for VRV IV X outdoor unit
- » Factory installed electronic expansion valve with PID control loop for precision capacity control
- » Seamless integration to full suite of Daikin controls using onboard control board
- » Air cleaner and humidifier integration capable<sup>1</sup>
- » UV and rust resistant, 5VA rated thermoplastic drain pan with integrated secondary drain
- » Foil-faced insulation covers internal casing to reduce cabinet condensation
- » Split seam front for easy installation and service access
- » Light weight all aluminum evaporator coil
- » Ships factory standard up flow with easy field conversion to downflow<sup>1</sup>
- » Backed by a 10-Year Parts Limited Warranty\*

<sup>1</sup>Rules apply, refer to installation manual for details.

OUTDOOR UNITS

INDOOR – CXTQ				CXTQ24TASBLU	CXTQ36TASBLU	CXTQ48TASBLU	CXTQ60TASBLU	
Model Name								
Power Supply		24VAC from gas furnace						
Nominal Tons		2		3		4		
*1,*3 Cooling Capacity	Btu/h (kW)	24,000 (7.0)		36,000 (10.6)		48,000 (14.1)		
*2,*3 Heating Capacity	Btu/h (kW)	27,000 (7.9)		40,000 (11.7)		54,000 (15.8)		
Casing / Color		Daikin Slate Gray						
Dimensions (H x W x D)	in. (mm)	22-1/16 x 17-23/32 x 24-7/32 (560 x 450 x 615)		22-1/16 x 17-23/32 x 24-7/32 (560 x 450 x 615)		30-1/16 x 21-7/32 x 24-7/32 (764 x 539 x 615)		
Coil	Type	Cased Upflow/Downflow A-coil						
	*4 Air pressure drop	in. w.g.	0.089"	0.240"	0.310"	0.329"		
Weight	lbs (kg)	46 (20.9)		52 (23.6)		72 (32.7)		
Pipe Connections	Liquid	in. (mm)	3/8" (9.5)		3/8" (9.5)		3/8" (9.5)	
	Gas	in. (mm)	5/8" (15.8)		5/8" (15.8)		5/8" (15.8)	
	Drain	in. (mm)	3/4" (19.1)		3/4" (19.1)		3/4" (19.1)	
Safety devices		Fuse						
Refrigerant Control		Electronic Expansion Valve						
Connectible Outdoor Unit		VRV IV X						

# Daikin VRV AURORA™

## Heat Recovery

### 208-230V & 460V

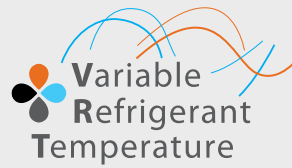

Daikin VRV AURORA Series heat recovery systems introduce a new benchmark for variable refrigerant flow system technology by integrating advanced technologies to provide comfort, control, energy efficiency and reliability. The Daikin VRV AURORA Series heat recovery systems set a new industry standard for heating and cooling solutions by delivering high heat capacities at low ambient applications.

### Features and Benefits

- » Variable refrigerant flow system Industry's first air-cooled system that delivers heating down to -22°F (-30°C) as standard
- » Daikin's inverter based vapor injection compressor is designed to deliver heating capacity of up to 100% of nominal at 0°F (-18°C), up to 85% of nominal at -13°F (-25°C) and up to 60% of nominal at -22°F (-30°C)
- » Optimized efficiencies delivered by dedicated all-inverter compressors and inverter fan motors
- » Refrigerant-cooled efficient and stable inverter board operation, independent of ambient conditions
- » Hot gas base pan circuit allows installation without an additional drain pan heater
- » Designed to provide continuous heating during defrost and oil return\*\*
- » Engineered with Daikin vapor injection compressor for optimized part load efficiencies
- » Added peace of mind with Auto Changeover ability to back up (auxiliary) heat



### Applications:



- » Long pipe lengths up to 1640 ft total and ability to connect up to 41\*\*\* indoor units with up to 100 ft vertical separation between indoor units provides design and installation flexibility
- » Corrosion resistant, 1000 hours salt spray tested Daikin PE blue fin heat exchanger
- » Ships factory standard with coil guards
- » Outstanding 10-Year Parts Warranty\* as standard.

\* Complete commercial warranty details available from your local distributor or manufacturer's representative or at [www.daikincomfort.com](http://www.daikincomfort.com) or [www.daikinac.com](http://www.daikinac.com).

\*\*Multi modules only for continuous heating during defrost

\*\*\*Varies by model

OUTDOOR UNITS



**VRV AURORA™ HEAT RECOVERY CERTIFIED DATA - HEAT RECOVERY, 208-230V/60HZ/3PH AND 460V/60HZ/3PH**

Product #	Capacity (Tons)	IEER Non-Ducted	IEER Ducted	IEER Mixed	SCHE Non-Ducted	SCHE Ducted	SCHE Mixed	COP @ 47°F Non-Ducted	COP @ 47°F Ducted	COP @ 47°F Mixed	COP @ 17°F Non-Ducted	COP @ 17°F Ducted	COP @ 17°F Mixed	EER Non-Ducted	EER Ducted	EER Mixed
RELQ72T	6	24.00	20.80	22.40	26.10	22.60	24.30	4.30	3.68	3.99	2.50	2.30	2.40	15.80	13.70	14.70
RELQ96T	8	24.80	19.10	21.90	25.70	19.70	22.70	4.23	3.42	3.83	2.50	2.25	2.37	15.30	12.50	13.90
RELQ120T	10	23.40	19.60	21.50	26.70	21.10	24.00	3.98	3.51	3.74	2.25	2.25	2.25	13.70	12.40	13.00
RELQ144T	12	22.50	18.60	20.50	25.50	23.80	24.60	3.81	3.55	3.68	2.20	2.20	2.20	12.90	12.60	12.70
RELQ192T	16	22.10	19.00	20.50	25.50	21.20	23.30	3.85	3.57	3.71	2.20	2.15	2.17	12.50	12.70	12.60
RELQ240T	20	21.10	18.60	19.80	24.90	20.80	22.80	3.68	3.49	3.59	2.20	2.13	2.16	12.30	11.70	12.00

Certified efficiency data in accordance with ANSI/AHRI Standard 1230 2014, "Performance Rating of Variable Refrigerant Flow Multi-Split Air Conditioning and Heat Pump Equipment" for the VRV Series. The VRV AURORA Series has been designed and optimized to meet or exceed the latest minimum efficiency requirements in 10 C.F.R. Part 431 as determined by the U.S. Department of Energy (DOE) and baseline efficiencies as defined by ASHRAE 90.1 2016. Systems under 65MBH are currently certified to AHRI 210/240. IEER ratings are as defined in ASHRAE 90.1 2016.

**DETAILED OPERATION RANGES FOR VRV/RELO\_T HEAT RECOVERY OUTDOOR UNITS**

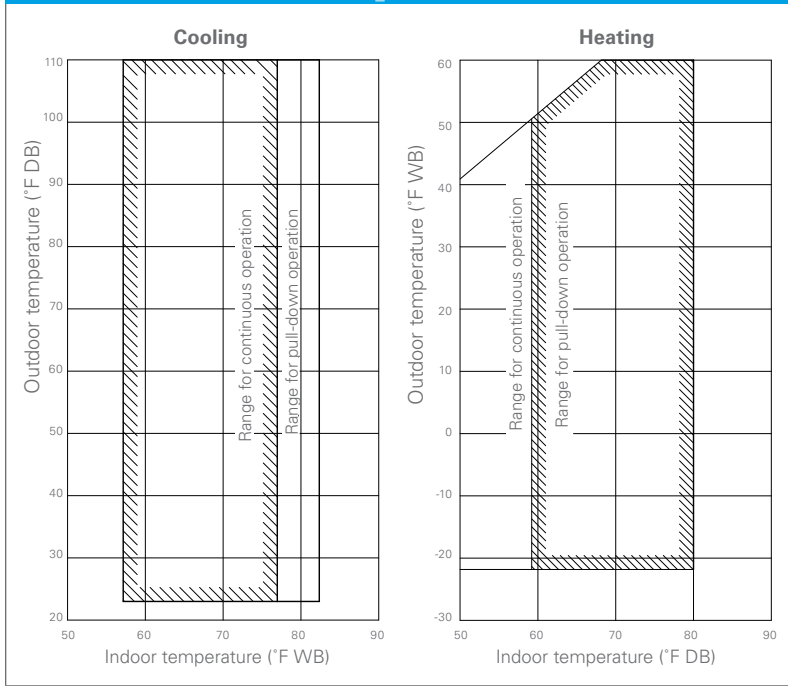

**TECHNICAL COOLING FEATURE FOR VRV/RELO\_T HEAT RECOVERY OUTDOOR UNITS**

**Technical Cooling -**  
Cooling operation extended from 23°F ambient air temperature down to -4°.  
The Technical Cooling feature is engaged by field settings on the outdoor unit and on branch selector boxes. It requires addition of wind covers to the unit and allows operation down to -4° FDB ambient temperature in cooling mode.  
See the Engineering Data book for complete application rules and contact your local Daikin representative for wind cover specification requirements.

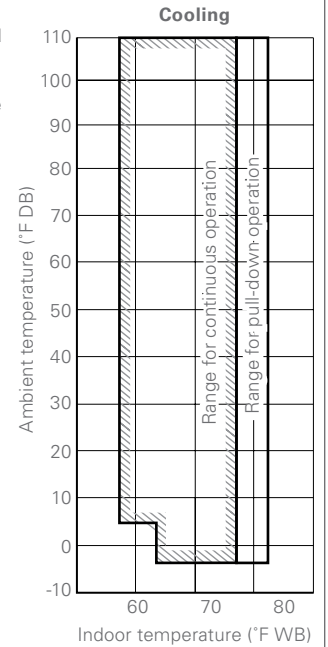

**OUTDOOR UNITS**

# Daikin VRV AURORA™

## Heat Recovery

### 208-230 & 460V (cont.)

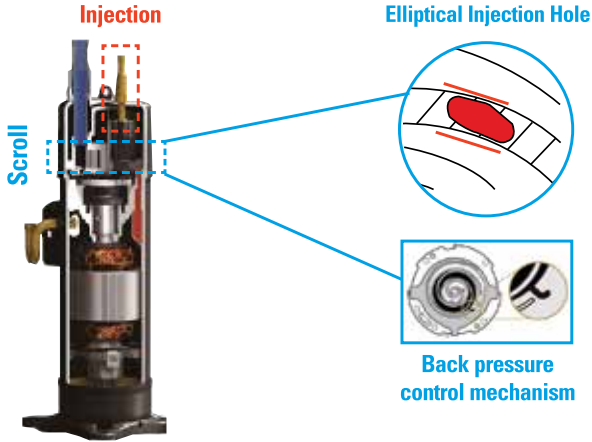
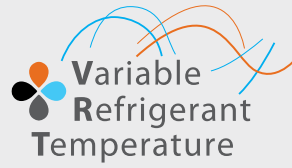

- » Compressor technology with new spiral design and injection valves for precise refrigerant control
- » Strong and efficient motors for optimized compressor performance and part load efficiencies
- » Patented back pressure control mechanism to minimize scroll pressure losses

OUTDOOR UNITS

TECHNICAL DATA FOR VRV AURORA RELQ_TATJU/TAYDU HEAT RECOVERY OUTDOOR UNITS			6 Ton	8 Ton	10 Ton
Model	208-230V/3Ph/60Hz		RELQ72TATJU	RELQ96TATJU	RELQ120TATJU
	460V/3Ph/60Hz		RELQ72TAYDU	RELQ96TAYDU	RELQ120TAYDU
	Combination				
Performance	Rated Cooling Capacity	BTU/h	69,000	92,000	114,000
	Rated Heating Capacity	BTU/h	77,000	103,000	129,000
	Operation Range Cooling	°F (°C) DB	23 <sup>1</sup> to 122		
	Operation Range Heating	°F (°C) WB	-22 to 60		
	Sound Pressure	dB(A)	60	61	64
	Airflow (Cooling)	CFM	6956	7989	8806
	Airflow (Heating)	CFM	7283	7283	7283
	Fan ESP, Standard/Max	in. Wg	0.12 / 0.32		
Compressor	Compressors, all inverter	Qty	1		
	Revolutions per minute	RPM	3738	3342	4350
	Capacity Control Range	%	11-100	10-100	9-100
Refrigerant Piping, Layout	Maximum Vertical Pipe Length Above Unit	ft.	164 (295 With Field Setting)		
	Maximum Vertical Pipe Length Below Unit	ft.	131 (195 With Field Setting)		
	Maximum Vertical Pipe Length Between IDU	ft.	100		
	Maximum Actual Pipe Length	ft.	541		
	Maximum Equivalent Pipe Length	ft.	620		
	Maximum Total Pipe Length	ft.	1,640		
Refrigerant Piping, Connections	Liquid Pipe (Main Line)	in.	3/8	3/8	1/2
	Suction Gas Pipe (Main Line)	in.	3/4	7/8	1-1/8
	Discharge Gas Pipe (Main Line)	in.	5/8	3/4	3/4
Connection Ratio	Standard Connectable Indoor Unit Ratio	%	70 - 200 <sup>2</sup>		
	Maximum Number of Indoor Units	Qty	12	16	20
Electrical	Maximum Overcurrent Protection, MOP (RELQ_TATJU / RELQ_TAYDU)	A	70 / 35	80 / 45	90 / 50
	Minimum Circuit Amps, MCA (RELQ_TATJU / RELQ_TAYDU)	A	60.8 / 28.1	76.5 / 39.8	83.4 / 43.4
	Compressor Rated Load Amps, RLA (RELQ_TATJU / RELQ_TAYDU)	A	20.7 / 9.4	36.8 / 16.6	39.3 / 17.8
Unit	Factory Refrigerant Charge	lbs.	25.8		
	Weight	lbs.	727	793	793
	Dimensions (H x W x D)	in.	66-11/16 X 48-7/8 X 30-3/16		

<sup>1</sup> Cooling operation can be extended down to -4°F with application rules and conditions  
<sup>2</sup> Varies based on indoor model selected



		12 Ton	16 Ton	20 Ton	
Model	208-230V/3Ph/60Hz	RELQ144TATJU	RELQ192TATJU	RELQ240TATJU	
	460V/3Ph/60Hz	RELQ144TAYDU	RELQ192TAYDU	RELQ240TAYDU	
	Combination	2 x RELQ72T	2 x RELQ96T	2 x RELQ120T	
Performance	Rated Cooling Capacity	BTU/h	138,000	184,000	228,000
	Rated Heating Capacity	BTU/h	154,000	206,000	256,000
	Operation Range Cooling	°F (°C) DB	23' to 122		
	Operation Range Heating	°F (°C) WB	-22 to 60		
	Sound Pressure	dB(A)	63	64	67
	Airflow (Cooling)	CFM	7283 + 7283	7989 + 7989	8806 + 8806
	Airflow (Heating)	CFM	6956 + 6956	7283 + 7283	7283 + 7283
	Fan ESP, Standard/Max	in. Wg	0.12 / 0.32		
Compressor	Compressors, all inverter	Qty	2		
	Revolutions per minute	RPM	3786 + 3786	3294 + 3294	4230 + 4230
	Capacity Control Range	%	6-100	5-100	4-100
Refrigerant Piping, Layout	Maximum Vertical Pipe Length Above Unit	ft.	164 (295 With Field Setting)		
	Maximum Vertical Pipe Length Below Unit	ft.	131 (195 With Field Setting)		
	Maximum Vertical Pipe Length Between IDU	ft.	100		
	Maximum Actual Pipe Length	ft.	541		
	Maximum Equivalent Pipe Length	ft.	620		
Refrigerant Piping, Connections	Maximum Total Pipe Length	ft.	1,640		
	Liquid Pipe (Main Line)	in.	1/2	5/8	5/8
	Suction Gas Pipe (Main Line)	in.	1-1/8	1-1/8	1-3/8
	Discharge Gas Pipe (Main Line)	in.	7/8	1-1/8	1-1/8
Connection Ratio	Standard Connectable Indoor Unit Ratio	%	70 - 200 <sup>2</sup>		
	Maximum Number of Indoor Units	Qty	25	33	41
Electrical	Maximum Overcurrent Protection, MOP (RELQ_TATJU / RELQ_TAYDU)	A	70 + 70 / 35 + 35	80 + 80 / 45 + 45	90 + 90 / 50 + 50
	Minimum Circuit Amps, MCA (RELQ_TATJU / RELQ_TAYDU)	A	60.8 + 60.8 / 28.1 + 28.1	76.5 + 76.5 / 39.8 + 39.8	83.4 + 83.4 / 43.4 + 43.4
	Compressor Rated Load Amps, RLA (RELQ_TATJU / RELQ_TAYDU)	A	21.6 + 21.6 / 9.8 + 9.8	38.1 + 38.1 / 17.3 + 17.3	40.4 + 40.4 / 18.3 + 18.3
Unit	Factory Refrigerant Charge	lbs.	25.8 + 25.8		
	Weight	lbs.	2 x 727	2 x 793	2 x 793
	Dimensions (H x W x D)	in.	66-11/16 X 48-7/8 X 30-3/16 + 66-11/16 X 48-7/8 X 30-3/16		

# Daikin VRV AURORA™

## Heat Pump

### 208-230V & 460V

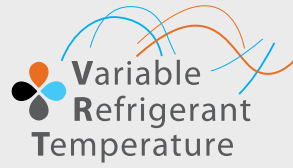

Daikin VRV AURORA Series systems introduce a new benchmark for variable refrigerant flow system technology by integrating advanced technologies to provide comfort, control, energy efficiency and reliability. The Daikin VRV AURORA Series systems set a new industry standard for heating and cooling solutions by delivering high heat capacities at low ambient applications.

### Features and Benefits

- » Variable refrigerant flow system Industry's first air-cooled system that delivers heating capacities down to -22°F (-30°C) as standard
- » Daikin's inverter based vapor injection compressor is designed to deliver heating capacity of up to 100% of nominal at 0°F (-18°C), up to 85% of nominal at -13°F (-25°C) and up to 60% of nominal at -22°F (-30°C)
- » Year round comfort and energy savings with Variable Refrigerant Temperature technology (VRT)
- » Refrigerant-cooled efficient and stable inverter board operation, independent of ambient conditions
- » Hot gas base pan circuit allows installation without an additional drain pan heater
- » Added peace of mind with Auto Changeover ability to back up (auxiliary) heat



### Applications:



- » Long pipe lengths up to 1640 ft. total and ability to connect up to 41\*\* indoor units with up to 100 ft. vertical separation between indoor units provides design and installation flexibility
- » Corrosion resistant, 1000 hours salt spray tested Daikin PE blue fin heat exchanger
- » Ships factory standard with coil guards
- » Outstanding 10-Year Parts Warranty\* as standard.

\* Complete commercial warranty details available from your local distributor or manufacturer's representative or at [www.daikincomfort.com](http://www.daikincomfort.com) or [www.daikinac.com](http://www.daikinac.com).

\*\* Varies by model

OUTDOOR UNITS



**VRV AURORA™ HEAT PUMP CERTIFIED DATA - HEAT PUMP, 208-230V/60HZ/3PH, 460V/60HZ/3PH**

Product #	Capacity (Tons)	IEER Non-Ducted	IEER Ducted	IEER Mixed	COP @ 47°F Non-Ducted	COP @ 47°F Ducted	COP @ 47°F Mixed	COP @ 17°F Non-Ducted	COP @ 17°F Ducted	COP @ 17°F Mixed	EER Non-Ducted	EER Ducted	EER Mixed
RXLQ72T	6	24.00	20.40	22.20	4.37	3.73	4.05	2.52	2.31	2.42	15.10	13.00	14.05
RXLQ96T	8	24.70	18.90	21.80	4.29	3.49	3.89	2.51	2.26	2.39	14.90	12.30	13.60
RXLQ120T	10	23.30	19.40	21.35	4.05	3.56	3.81	2.27	2.26	2.27	13.50	12.20	12.85
RXLQ144T	12	22.40	18.20	20.30	3.86	3.56	3.71	2.21	2.21	2.21	12.70	12.40	12.55
RXLQ192T	16	22.00	18.80	20.40	3.90	3.61	3.76	2.22	2.16	2.19	12.30	12.50	12.40
RXLQ240T	20	21.00	18.60	19.80	3.77	3.53	3.65	2.22	2.13	2.18	12.10	11.50	11.80

Certified efficiency data in accordance with ANSI/AHRI Standard 1230 2014, "Performance Rating of Variable Refrigerant Flow Multi-Split Air Conditioning and Heat Pump Equipment" for the VRV Series. The VRV AURORA Series has been designed and optimized to meet or exceed the latest minimum efficiency requirements in 10 C.F.R. Part 431 as determined by the U.S. Department of Energy (DOE) and baseline efficiencies as defined by ASHRAE 90.1 2016. Systems under 65MBH are currently certified to AHRI 210/240. IEER ratings are as defined in ASHRAE 90.1 2016.

**DETAILED OPERATION RANGES FOR VRV/RXLQ\_T HEAT PUMP OUTDOOR UNITS**

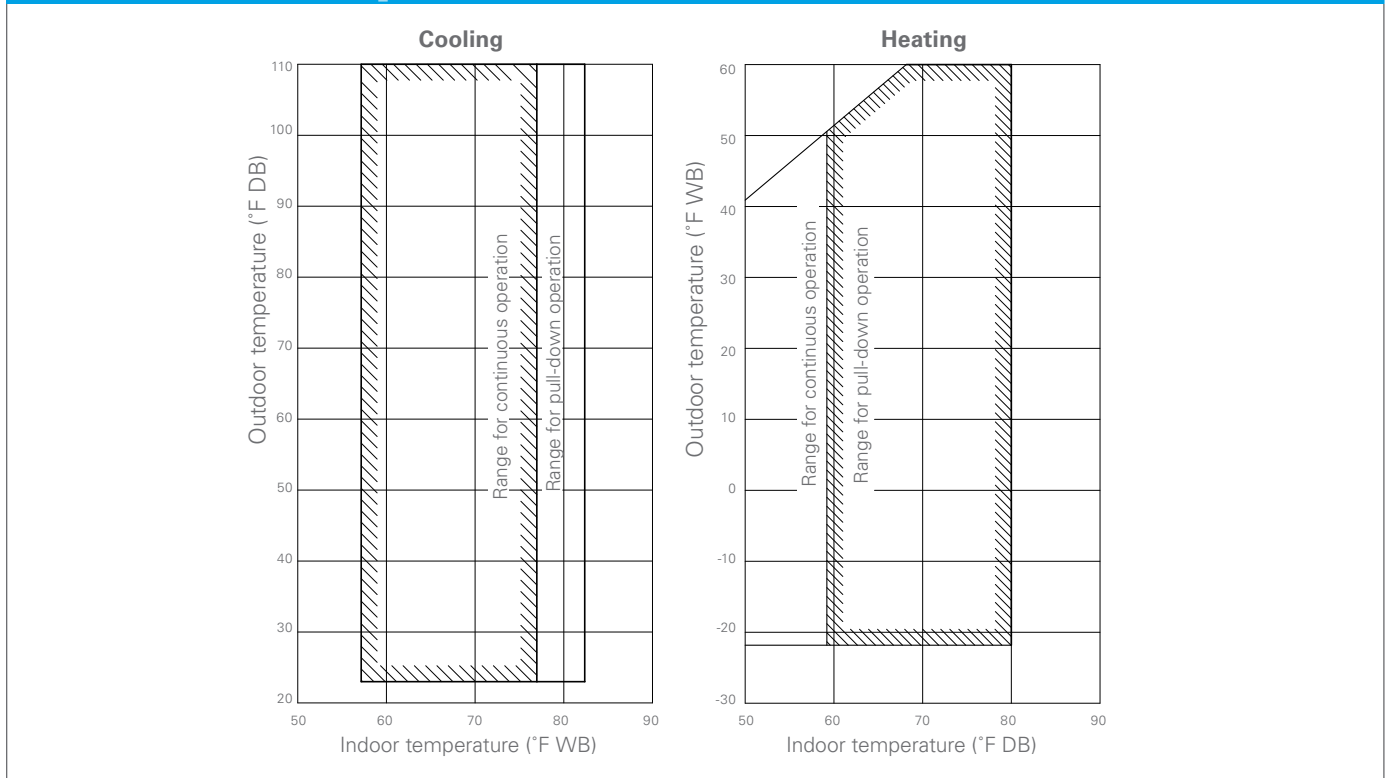

OUTDOOR UNITS

# Daikin VRV AURORA™

## Heat Pump

### 208-230 & 460V (cont.)

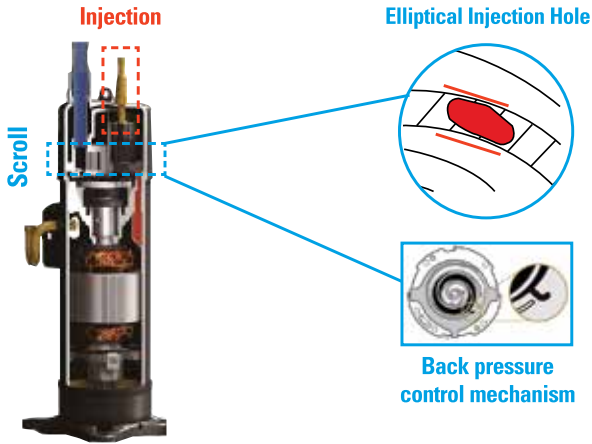
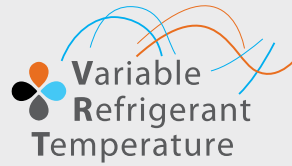

- » Compressor technology with new spiral design and injection valves for precise refrigerant control
- » Strong and efficient motors for optimized compressor performance and part load efficiencies
- » Patented back pressure control mechanism to minimize scroll pressure losses

OUTDOOR UNITS

TECHNICAL DATA FOR VRV AURORA RXLO_T			6 Ton	8 Ton	10 Ton
Model		208-230V/3Ph/60Hz	RXLQ72TATJU	RXLQ96TATJU	RXLQ120TATJU
		460V/3Ph/60Hz	RXLQ72TAYDU	RXLQ96TAYDU	RXLQ120TAYDU
		Combination			
Performance	Rated Cooling Capacity	BTU/h	69,000	92,000	114,000
	Rated Heating Capacity	BTU/h	77,000	103,000	129,000
	Operation Range Cooling	°F (°C) DB	23 to 122		
	Operation Range Heating	°F (°C) WB	-22 to 60		
	Sound Pressure	dB(A)	60	61	64
	Airflow	CFM	7283	7989	8806
	Fan ESP, Standard/Max	in. Wg	0.12 / 0.32		
Compressor	Compressors, all inverter	Qty	1		
	Revolutions per minute	RPM	3738	3294	4350
	Capacity Control Range	%	11-100	13-100	12-100
Refrigerant Piping, Layout	Maximum Vertical Pipe Length Above Unit	ft.	164 (295 With Field Setting)		
	Maximum Vertical Pipe Length Below Unit	ft.	131 (195 With Field Setting)		
	Maximum Vertical Pipe Length Between IDU	ft.	100		
	Maximum Actual Pipe Length	ft.	541		
	Maximum Equivalent Pipe Length	ft.	620		
Maximum Total Pipe Length	ft.	1,640			
Refrigerant Piping, Connections	Liquid Pipe (Main Line)	in.	3/8	3/8	1/2
	Suction Gas Pipe (Main Line)	in.	3/4	7/8	1-1/8
Connection Ratio	Standard Connectable Indoor Unit Ratio	%	70 - 200 <sup>1</sup>		
	Maximum Number of Indoor Units	Qty	12	16	20
Electrical	Maximum Overcurrent Protection, MOP (RXLO_TATJU / RXLO_TAYDU)	A	70 / 35	80 / 45	90 / 50
	Minimum Circuit Amps, MCA (RXLO_TATJU / RXLO_TAYDU)	A	60.8 / 28.1	76.5 / 39.8	83.4 / 43.4
	Compressor Rated Load Amps, RLA (RXLO_TATJU / RXLO_TAYDU)	A	23.9 / 10.4	42.2 / 18.3	41.4 / 18.0
Unit	Factory Refrigerant Charge	lbs.	25.8		
	Weight	lbs.	727	793	793
	Dimensions (H x W x D)	in.	66-11/16 X 48-7/8 X 30-3/16		

<sup>1</sup>Varies based on indoor model selected

		12 Ton	16 Ton	20 Ton	
Model	208-230V/3Ph/60Hz	RXLQ144TATJU	RXLQ192TATJU	RXLQ240TATJU	
	460V/3Ph/60Hz	RXLQ144TAYDU	RXLQ192TAYDU	RXLQ240TAYDU	
	Combination	2 x RXLQ72T	2 x RXLQ96T	2 x RXLQ120T	
Performance	Rated Cooling Capacity	BTU/h	138,000	184,000	228,000
	Rated Heating Capacity	BTU/h	154,000	206,000	256,000
	Operation Range Cooling	°F (°C) DB	23 to 122		
	Operation Range Heating	°F (°C) WB	-22 to 60		
	Sound Pressure	dB(A)	63	64	67
	Airflow (Cooling)	CFM	7283 + 7283	7989 + 7989	8806 + 8806
	Fan ESP, Standard/Max	in. Wg	0.12 / 0.32		
Compressor	Compressors, all inverter	Qty	2		
	Revolutions per minute	RPM	3804 + 3804	3342 + 3342	4230 + 4230
	Capacity Control Range	%	6-100	6-100	6-100
Refrigerant Piping, Layout	Maximum Vertical Pipe Length Above Unit	ft.	164 (295 With Field Setting)		
	Maximum Vertical Pipe Length Below Unit	ft.	131 (195 With Field Setting)		
	Maximum Vertical Pipe Length Between IDU	ft.	100		
	Maximum Actual Pipe Length	ft.	541		
	Maximum Equivalent Pipe Length	ft.	620		
Refrigerant Piping, Connections	Maximum Total Pipe Length	ft.	1,640		
	Liquid Pipe (Main Line)	in.	1/2	5/8	5/8
Connection Ratio	Suction Gas Pipe (Main Line)	in.	1-1/8	1-1/8	1-3/8
	Standard Connectable Indoor Unit Ratio	%	70 - 200 <sup>1</sup>		
Electrical	Maximum Number of Indoor Units	Qty	25	33	41
	Maximum Overcurrent Protection, MOP (RXLQ_TATJU / RXLQ_TAYDU)	A	70 + 70 / 35 + 35	80 + 80 / 45 + 45	90 + 90 / 50 + 50
	Minimum Circuit Amps, MCA (RXLQ_TATJU / RXLQ_TAYDU)	A	60.8 + 60.8 / 28.1 + 28.1	76.5 + 76.5 / 39.8 + 39.8	83.4 + 83.4 / 43.4 + 43.4
Unit	Compressor Rated Load Amps, RLA (RXLQ_TATJU / RXLQ_TAYDU)	A	23.9 + 23.9 / 10.4 + 10.4	40.8 + 40.8 / 17.7 + 17.7	41.7 + 41.7 / 18.2 + 18.2
	Factory Refrigerant Charge	lbs.	25.8 + 25.8		
	Weight	lbs.	2 x 727	2 x 793	2 x 793
	Dimensions (H x W x D)	in.	66-11/16 X 48-7/8 X 30-3/16 + 66-11/16 X 48-7/8 X 30-3/16		

## VRV IV

# Air-Cooled Heat Recovery

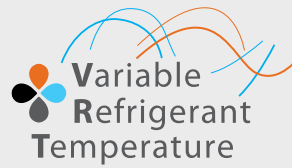

Daikin's VRV IV systems integrate advanced technology to provide comfort control with high energy efficiency and reliability. VRV IV provides heating and cooling solutions for multi-family residential to large commercial applications. Daikin VRV IV is the first variable refrigerant flow system assembled in North America.

### Features and Benefits

- » Total comfort solution for heating, cooling, ventilation and controls.
- » Redesigned and optimized for low total Life Cycle Cost (LCC).
- » Available in large capacity single modules up to 14 tons and systems up to 38 tons allowing for flexible system design.
- » Year-round comfort and energy efficiency delivered by combining VRV and VRT technologies.
- » Compatible with Daikin DVS series of Dedicated Outdoor Air Systems (DOAS).
- » High energy efficiency with IEER values up to 29.3.
- » Integrated inverter technology delivers high efficiency during part load conditions and provides precise individual zone control.
- » Design flexibility with long piping lengths up to 3,280 ft. total, and up to 100 ft. vertical separation between indoor units.
- » Daikin PE blue fin heat exchanger.

## VRV IV



- » Single/multiple port branch selector boxes provide compact dimensions and a wide range of product offerings (single, 4, 6, 8, 10 and 12 port options).
- » Reduced commissioning time with VRV configuration software and Graphical User Interface (GUI), as compared to VRV III.
- » VRV IV takes advantage of Daikin's unique zone and centralized controls that are optimized for the specific needs of North America.
- » Outstanding 10-Year Parts Warranty\* as standard.

\* Complete commercial warranty details available from your local distributor or manufacturer's representative or at [www.daikincomfort.com](http://www.daikincomfort.com) or [www.daikinac.com](http://www.daikinac.com).



OUTDOOR UNITS

**VRV IV CERTIFIED DATA - HEAT RECOVERY, 208-230V/60HZ/3PH AND 460V/60HZ/3PH**

Product #	Capacity (Tons)	IEER Non-Ducted	IEER Ducted	IEER Mixed	SCHE Non-Ducted	SCHE Ducted	SCHE Mixed	COP @ 47°F Non-Ducted	COP @ 47°F Ducted	COP @ 47°F Mixed	COP @ 17°F Non-Ducted	COP @ 17°F Ducted	COP @ 17°F Mixed	EER Non-Ducted	EER Ducted	EER Mixed
REYQ72T	6	24.90	20.90	22.90	25.40	21.40	23.40	4.31	3.58	3.95	2.70	2.43	2.56	15.00	12.20	13.60
REYQ96T	8	29.30	23.10	26.20	24.70	23.00	23.85	4.25	3.67	3.96	2.47	2.25	2.36	14.20	12.40	13.30
REYQ120T	10	25.40	22.60	24.00	25.90	25.10	25.50	4.00	3.51	3.76	2.45	2.25	2.35	12.90	12.10	12.50
REYQ144T	12	23.50	21.60	22.55	25.00	23.80	24.40	3.81	3.48	3.65	2.52	2.29	2.40	12.40	11.90	12.15
REYQ168T	14	21.90	20.40	21.15	26.00	24.10	25.05	3.64	3.21	3.43	2.20	2.09	2.15	11.30	10.90	11.10
REYQ192T	16	22.90	21.10	22.00	26.60	23.10	24.85	3.85	3.67	3.76	2.38	2.26	2.32	12.50	12.30	12.40
REYQ216T	18	23.00	20.80	21.90	25.60	22.80	24.20	3.74	3.66	3.70	2.32	2.18	2.25	12.50	12.20	12.35
REYQ240T	20	21.90	19.80	20.85	25.60	22.70	24.15	3.68	3.51	3.60	2.24	2.09	2.17	11.90	11.60	11.75
REYQ264T	22	21.60	18.60	20.10	24.40	22.00	23.20	3.55	3.20	3.38	2.33	2.08	2.21	11.60	10.40	11.00
REYQ288T	24	21.00	17.90	19.45	23.30	21.80	22.55	3.51	3.20	3.36	2.41	2.13	2.27	11.40	10.30	10.85
REYQ312T	26	20.20	18.00	19.10	23.90	20.70	22.30	3.57	3.20	3.39	2.35	2.10	2.23	11.00	10.00	10.50
REYQ336T	28	19.00	17.30	18.15	23.50	20.60	22.05	3.53	3.20	3.37	2.18	2.05	2.12	10.30	9.60	9.95
REYQ360T	30	19.60	18.80	19.20	22.70	20.30	21.50	3.52	3.27	3.40	2.28	2.05	2.17	10.80	10.70	10.75
REYQ384T	32	18.30	18.00	18.15	22.50	18.70	20.60	3.21	3.20	3.21	2.22	2.05	2.14	9.80	9.80	9.80
REYQ408T	34	17.20	17.70	17.45	21.80	18.30	20.05	3.21	3.20	3.21	2.09	2.05	2.07	9.80	9.70	9.75
REYQ432T	36	16.20	17.30	16.75	20.20	18.10	19.15	3.21	3.20	3.21	2.08	2.06	2.07	9.80	9.70	9.75
REYQ456T	38	16.20	16.70	16.45	18.80	17.90	18.35	3.21	3.20	3.21	2.07	2.05	2.06	9.30	9.50	9.40

Certified efficiency data in accordance with ANSI/AHRI Standard 1230 2014, "Performance Rating of Variable Refrigerant Flow Multi-Split Air Conditioning and Heat Pump Equipment" for the VRV Series. The VRV IV Series has been designed and optimized to meet or exceed the latest minimum efficiency requirements in 10 C.F.R. Part 431 as determined by the U.S. Department of Energy (DOE) and baseline efficiencies as defined by ASHRAE 90.1 2016. Systems under 65MBH are currently certified to AHRI 210/240. IEER ratings are as defined in ASHRAE 90.1 2016.

OUTDOOR UNITS

**DETAILED OPERATION RANGES FOR VRV IV REYQ\_T HEAT RECOVERY OUTDOOR UNITS**

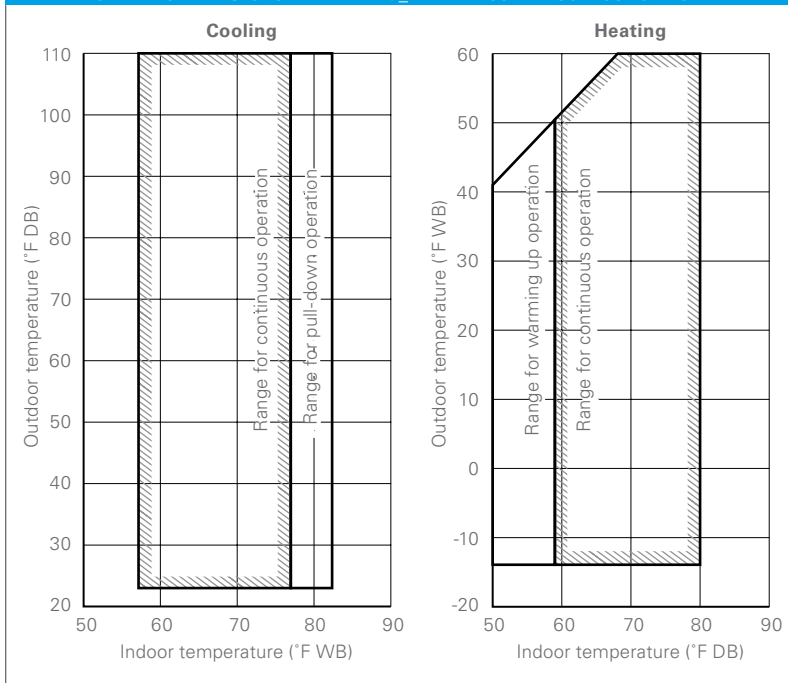

**TECHNICAL COOLING FEATURE FOR VRV IV REYQ\_T HEAT RECOVERY OUTDOOR UNITS**

**Technical Cooling** - Cooling operation extended from 23°F ambient air temperature down to -4°.

The Technical Cooling feature is engaged by field settings on the outdoor unit and on branch selector boxes. It requires addition of wind covers to the unit and allows operation down to -4° FDB ambient temperature in cooling mode.

See the Engineering Data book for complete application rules and contact your local Daikin representative for wind cover specification requirements.

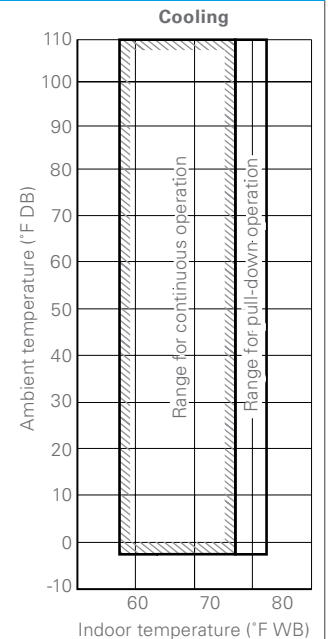

# VRV IV

## Air-Cooled Heat Recovery (cont.)

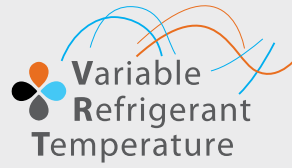

### TECHNICAL DATA FOR VRV IV REYQ\_TATJU/TAYDU HEAT RECOVERY OUTDOOR UNITS

		6 Ton	8 Ton	10 Ton	12 Ton	14 Ton	16 Ton	18 Ton	20 Ton		
Model	208-230V/3Ph/60Hz	REYQ72TATJU	REYQ96TATJU	REYQ120TATJU	REYQ144TATJU	REYQ168TATJU	REYQ192TATJU	REYQ216TATJU	REYQ240TATJU		
	460V/3Ph/60Hz	REYQ72TAYDU	REYQ96TAYDU	REYQ120TAYDU	REYQ144TAYDU	REYQ168TAYDU	REYQ192TAYDU	REYQ216TAYDU	REYQ240TAYDU		
Combination							1 x REYQ120T 1 x REYQ72T	1 x REYQ120T 1 x REYQ96T	1 x REYQ144T 1 x REYQ96T		
Performance	Rated Cooling Capacity	BTU/h	69,000	92,000	114,000	138,000	160,000	184,000	206,000	228,000	
	Rated Heating Capacity	BTU/h	75,000	100,000	126,000	150,000	176,000	200,000	226,000	250,000	
	Sound Pressure	dB(A)	58	61		65		63	64	66	
	IEER (Ducted / Non-Ducted)		20.9 / 24.9	23.1 / 29.3	22.6 / 25.4	21.6 / 23.5	20.4 / 21.9	21.1 / 22.9	20.8 / 23.0	19.8 / 21.9	
	Airflow	CFM	5,544	5,827	6,286	8,228		5,544 + 6,286	5,827 + 6,286	5,827 + 8,228	
	Fan ESP, Standard/Max	in. Wg	0.12 / 0.32								
Compressor	Compressors, all inverter	Qty	1	2			3	4			
	Revolutions per minute	RPM	3600	3630, 3630	4470, 4470	4440, 4440	5190, 5190	4080, (4290, 4290)	(4170, 4170) x 2	(4050, 4050), (4110, 4110)	
	Capacity Control Range	%	15-100	11-100	10-100			5-100			
Refrigerant Piping, Layout	Maximum Vertical Pipe Length Above Unit	ft.	164 (295 With Field Setting)								
	Maximum Vertical Pipe Length Below Unit	ft.	131 (195 With Field Setting)								
	Maximum Vertical Pipe Length Between IDU	ft.	100								
	Maximum Actual Pipe Length	ft.	541								
	Maximum Equivalent Pipe Length	ft.	620								
	Maximum Total Pipe Length	ft.	3,280								
Refrigerant Piping, Connections	Liquid Pipe, Main Line	in.	Ø3/8 (9.5) C1220T (Brazeing Connection)		Ø1/2 (12.7) C1220T (Brazeing Connection)		Ø5/8 (15.9) C1220T (Brazeing Connection)				
	Suction Gas Pipe, Main Line	in.	Ø3/4 (19.1) C1220T (Brazeing Connection)	Ø7/8 (22.2) C1220T (Brazeing Connection)	Ø1-1/8 (28.6) C1220T (Brazeing Connection)				Ø1-3/8 (34.9) C1220T (Brazeing Connection)		
	Discharge Gas Pipe, Main Line	in.	Ø5/8 (15.9) C1220T (Brazeing Connection)	Ø3/4 (19.1) C1220T (Brazeing Connection)		Ø7/8 (22.2) C1220T (Brazeing Connection)		Ø1-1/8 (28.6) C1220T (Brazeing Connection)			
Connection Ratio	Standard Connectable Indoor Unit Ratio	%	50 - 200								
	Maximum Number of Indoor Units	Qty	12	16	20	25	29	33	37	41	
Electrical	Maximum Overcurrent Protection, MOP (REYQ_TAT / REYQ_TAY)	A	35/20	45/25	50/25	70/40		35 + 50 / 20 + 25	45 + 50 / 25 + 25	45 + 70 / 25 + 40	
	Minimum Circuit Amps, MCA (REYQ_TAT / REYQ_TAY)	A	30.2 / 15.2	38 / 21.1	43 / 21.1	55 / 31.9	61.9 / 36.1	30.2 + 43 / 15.2 + 21.1	38 + 43 / 21.1 + 21.1	38 + 55 / 21.1 + 31.9	
	Compressor Rated Load Amps, RLA (REYQ_TAT / REYQ_TAY)	A	20.7 / 9.4	13.7 + 13.7 / 6.2 + 6.2	15 + 15 / 6.8 + 6.8	16.2 + 22.6 / 7.3 + 10.3	17.4 + 24.4 / 7.9 + 11.1	20.7 + (15 + 15) / 9.4 + (6.8 + 6.8)	(13.7 + 13.7) + (15 + 15) / (6.2 + 6.2) + (6.8 + 6.8)	(13.7 + 13.7) + (16.2 + 22.6) / (6.2 + 6.2) + (7.3 + 10.3)	
Unit	Factory Refrigerant Charge	lbs.	21.9	25.8			21.9 + 25.8		25.8 + 25.8		
	Weight (REYQ_TAT / REYQ_TAY)	lbs.	507 / 527	703 / 717	703 / 717	780 / 794		507 + 703 / 527 + 717	703 + 703 / 717 + 717	703 + 780 / 717 + 794	
	Dimensions (H x W x D)	in.	66-11/16 x 36-11/16 x 30-3/16	66-11/16 x 48-7/8 x 30-3/16				66-11/16 x 48-7/8 x 30-3/16 + (66-11/16 x 36-11/16 x 30-3/16)	66-11/16 x 48-7/8 x 30-3/16 + (66-11/16 x 48-7/8 x 30-3/16)		

### OPERATION RANGE FOR ALL VRV IV HEAT RECOVERY OUTDOOR UNITS

Cooling °F DB	-4* – 122
Heating °F WB	-13 – 60

\*Application rules apply



	22 Ton	24 Ton	26 Ton	28 Ton	30 Ton	32 Ton	34 Ton	36 Ton	38 Ton
	REYQ264TATJU	REYQ288TATJU	REYQ312TATJU	REYQ336TATJU	REYQ360TATJU	REYQ384TATJU	REYQ408TATJU	REYQ432TATJU	REYQ456TATJU
	REYQ264TAYDU	REYQ288TAYDU	REYQ312TAYDU	REYQ336TAYDU	REYQ360TAYDU	REYQ384TAYDU	REYQ408TAYDU	REYQ432TAYDU	REYQ456TAYDU
	1 x REYQ144T 1 x REYQ120T	2 x REYQ144T	1 x REYQ168T 1 x REYQ144T	2 x REYQ168T	3 x REYQ120T	1 x REYQ168T 1 x REYQ120T 1 x REYQ96T	1 x REYQ168T 1 x REYQ144T 1 x REYQ96T	3 x REYQ144T	1 x REYQ168T 2 x REYQ144T
	252,000	274,000	296,000	320,000	342,000	364,000	388,000	410,000	430,000
	274,000	288,000	306,000	316,000	376,000	386,000	394,000	405,000	415,000
	66	68			66	68	69	70	
	18.6 / 21.6	17.9 / 21.0	18.0 / 20.2	17.3 / 19.0	18.8 / 19.6	18.0 / 18.3	17.7 / 17.2	17.3 / 16.2	16.7 / 16.2
	6,286 + 8,228	8,228 + 8,228	8,228 + 8,228		6,286 + 6,286 + 6,286	5,827 + 6,286 + 8,228	5,827 + 8,228 + 8,228	8,228 + 8,228 + 8,228	
	0.12/0.32								
	4				6				
	(4710, 4710), (4800, 4800)	(4740, 4740) x 2	(5790, 5790) x 2		(5010, 5010) x 3	(5070, 5070) x 2, (5160, 5160)	(5040, 5040), (5130, 5130) x 2	(5220, 5220) x 3	(5730, 5730) x 3
	5-100				3-100				
	164 (295 With Field Setting)								
	131 (195 With Field Setting)								
	100								
	541								
	620								
	3,280								
	Ø3/4 (19.1) C1220T (Brazeing Connection)								
	Ø1-3/8 (34.9) C1220T (Brazeing Connection)				Ø1-5/8 (41.3) C1220T (Brazeing Connection)				
	Ø1-1/8 (28.6) C1220T (Brazeing Connection)				Ø1-3/8 (34.9) C1220T (Brazeing Connection)				
	50 - 200								
	45	49	54	58	64				
	50 + 70 / 25 + 40	70 + 70 / 40 + 40			50 + 50 + 50 / 25 + 25 + 25	45 + 50 + 70 / 25 + 25 + 40	45 + 70 + 70 / 25 + 40 + 40	70 + 70 + 70 / 40 + 40 + 40	70 + 70 + 70 / 40 + 40 + 40
	43 + 55 / 21.1 + 31.9	55 + 55 / 31.9 + 31.9	55 + 61.9 / 31.9 + 36.1	61.9 + 61.9 / 36.1 + 36.1	43 + 43 + 43 / 21.1 + 21.1 + 21.1	38 + 43 + 61.9 / 21.1 + 21.1 + 21.1	38 + 55 + 61.9 / 21.1 + 31.9 + 36.1	55 + 55 + 55 / 31.9 + 31.9 + 31.9	55 + 55 + 61.9 / 31.9 + 31.9 + 36.1
	(15 + 15) + (16.2 + 22.6) / (6.8 + 6.8) + (7.3 + 10.3)	(16.2 + 22.6) x 2 / (7.3 + 10.3) x 2	(16.2 + 22.6) + (17.4 + 24.4) / (7.3 + 10.3) + (7.9 + 11.1)	(17.4 + 24.4) x 2 / (7.9 + 11.1) x 2	(15 + 15) x 3 / (6.8 + 6.8) x 3	(13.7 + 13.7) + (16.2 + 22.6) + (17.4 + 24.4) / (6.2 + 6.2) + (6.8 + 6.8) + (7.9 + 11.1)	(13.7 + 13.7) + (16.2 + 22.6) + (17.4 + 24.4) / (6.2 + 6.2) + (7.3 + 10.3) + (7.9 + 11.1)	(16.2 + 22.6) x 3 / (7.3 + 10.3) x 3	(16.2 + 22.6) x 2 + (17.4 + 24.4) / (7.3 + 10.3) x 2 + (7.9 + 11.1)
	25.8 + 25.8				25.8 + 25.8 + 25.8				
	703 + 780 / 717 + 794	780 + 780 / 794 + 794			703 + 703 + 703 / 717 + 717 + 717	703 + 703 + 780 / 717 + 717 + 794	780 + 780 + 780 / 717 + 794 + 794	780 + 780 + 780 / 794 + 794 + 794	
	(66-11/16 x 48-7/8 x 30-3/16) + (66-11/16 x 48-7/8 x 30-3/16)				(66-11/16 x 48-7/8 x 30-3/16) + (66-11/16 x 48-7/8 x 30-3/16) + (66-11/16 x 48-7/8 x 30-3/16)				

OUTDOOR UNITS

For additional technical information please refer to specific Engineering Data Books.

# VRV IV

## Air-Cooled Heat Pump

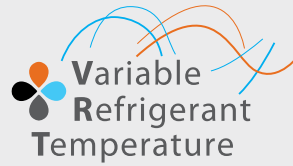

Daikin's VRV IV systems integrate advanced technology to provide comfort control helping to maximize energy efficiency and reliability. VRV IV provides heating and cooling solutions for multi-family residential to large commercial applications. Daikin VRV IV is the first variable refrigerant flow system assembled in North America.

### Features and Benefits

- » Total comfort solution for heating, cooling, ventilation and controls.
- » Redesigned and optimized for low total Life Cycle Cost (LCC).
- » Available in large capacity single modules up to 14 tons and systems up to 34 tons allowing for a more flexible system design.
- » Year-round comfort and energy efficiency delivered by combining VRV and VRT technologies.
- » High energy efficiency with IEER values up to 27.3.
- » Integrated inverter technology delivers high efficiency during part load conditions and provides precise individual zone control.
- » Design flexibility with long piping lengths up to 3,280 ft. total, and up to 100 ft. vertical separation between indoor units.
- » Corrosion resistant 1000 hr. salt-spray tested Daikin PE blue fin heat exchanger.

## VRV IV



- » Reduced commissioning time with VRV configuration software and Graphical User Interface (GUI), as compared to VRV III.
- » VRV IV takes advantage of Daikin's unique zone and centralized controls that are optimized for the specific needs of North America.
- » Outstanding 10-Year Parts Warranty\* as standard.

\* Complete commercial warranty details available from your local distributor or manufacturer's representative or at [www.daikincomfort.com](http://www.daikincomfort.com) or [www.daikinac.com](http://www.daikinac.com).

OUTDOOR UNITS



**VRV IV CERTIFIED DATA - HEAT PUMP, 208-230V/60HZ/3PH AND 460V/60HZ/3PH**

Product #	Capacity (Tons)	IEER Non-Ducted	IEER Ducted	IEER Mixed	COP @ 47°F Non-Ducted	COP @ 47°F Ducted	COP @ 47°F Mixed	COP @ 17°F Non-Ducted	COP @ 17°F Ducted	COP @ 17°F Mixed	IEER Non-Ducted	IEER Ducted	IEER Mixed
RXYQ72T	6	25.80	20.70	23.25	3.67	3.30	3.49	2.44	2.25	2.35	14.70	12.70	13.70
RXYQ96T	8	27.30	22.50	24.90	4.00	3.49	3.75	2.63	2.48	2.56	14.00	12.60	13.30
RXYQ120T	10	25.40	22.00	23.70	3.50	3.30	3.40	2.25	2.37	2.31	12.00	11.60	11.80
RXYQ144T	12	24.80	22.60	23.70	3.64	3.34	3.49	2.33	2.20	2.27	12.10	11.50	11.80
RXYQ168T	14	22.60	19.80	21.20	3.34	3.20	3.27	2.34	2.27	2.31	10.60	10.60	10.60
RXYQ192T	16	22.20	21.20	21.70	3.62	3.29	3.46	2.27	2.23	2.25	11.10	11.60	11.35
RXYQ216T	18	20.50	21.10	20.80	3.83	3.50	3.67	2.57	2.46	2.52	10.70	10.90	10.80
RXYQ240T	20	20.80	20.90	20.85	3.63	3.33	3.48	2.41	2.34	2.38	11.00	11.20	11.10
RXYQ264T	22	20.30	19.60	19.95	3.33	3.24	3.29	2.43	2.30	2.37	10.30	9.60	9.95
RXYQ288T	24	20.10	19.60	19.85	3.25	3.30	3.28	2.07	2.13	2.10	10.50	10.10	10.30
RXYQ312T	26	19.90	18.80	19.35	3.30	3.21	3.26	2.32	2.20	2.26	9.80	9.60	9.70
RXYQ336T	28	20.60	18.50	19.55	3.22	3.20	3.21	2.38	2.27	2.33	9.50	9.50	9.50
RXYQ360T	30	19.40	18.50	18.95	3.46	3.20	3.33	2.47	2.36	2.42	10.30	9.80	10.05
RXYQ384T	32	21.10	18.50	19.80	3.30	3.20	3.25	2.28	2.27	2.28	9.50	9.50	9.50
RXYQ408T	34	21.10	19.00	20.05	3.24	3.20	3.22	2.18	2.10	2.14	9.50	9.50	9.50

Certified efficiency data in accordance with ANSI/AHRI Standard 1230 2014, "Performance Rating of Variable Refrigerant Flow Multi-Split Air Conditioning and Heat Pump Equipment" for the VRV Series. The VRV IV Series has been designed and optimized to meet or exceed the latest minimum efficiency requirements in 10 C.F.R. Part 431 as determined by the U.S. Department of Energy (DOE) and baseline efficiencies as defined by ASHRAE 90.1 2016. Systems under 65MBH are currently certified to AHRI 210/240. IEER ratings are as defined in ASHRAE 90.1 2016.

**DETAILED OPERATION RANGES FOR VRV IV RXYQ\_T HEAT PUMP OUTDOOR UNITS**

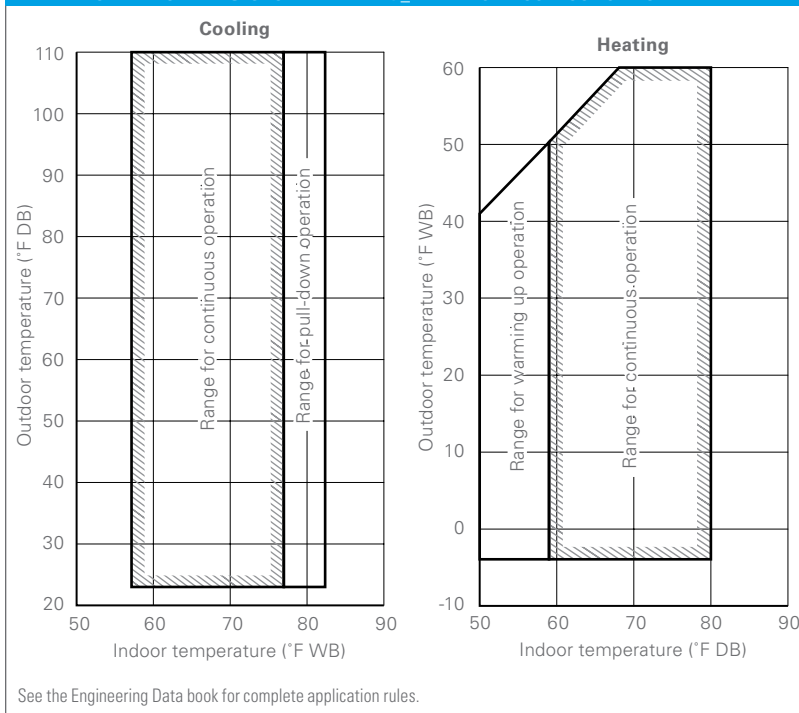

**LOW AMBIENT COOLING OPERATION FOR VRV IV RXYQ\_T SINGLE MODULE HEAT PUMP OUTDOOR UNITS**

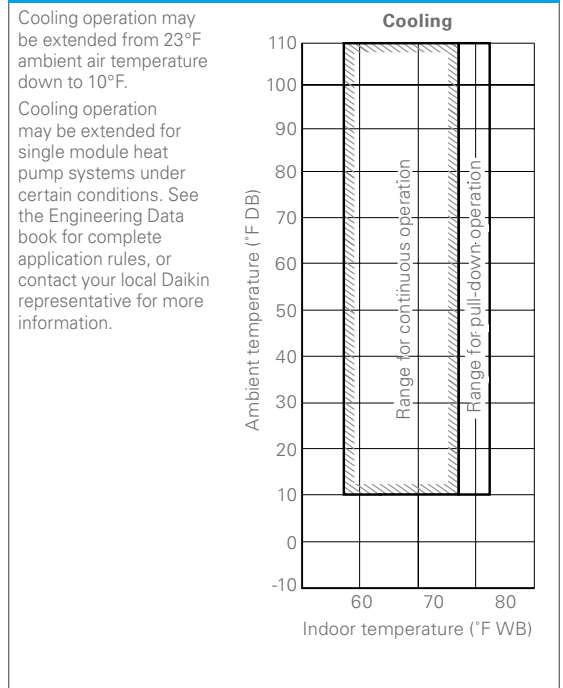

OUTDOOR UNITS

# VRV IV

## Air-Cooled Heat Pump (cont.)

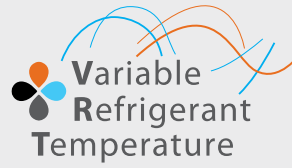

### TECHNICAL DATA FOR VRV IV RXYQ\_TATJU/TAYDU HEAT PUMP OUTDOOR UNITS

		6 Ton	8 Ton	10 Ton	12 Ton	14 Ton	16 Ton	18 Ton	20 Ton	
Model	208-230V/3Ph/60Hz	RXYQ72TATJU	RXYQ96TATJU	RXYQ120TATJU	RXYQ144TATJU	RXYQ168TATJU	RXYQ192TATJU	RXYQ216TATJU	RXYQ240TATJU	
	460V/3Ph/60Hz	RXYQ72TAYDU	RXYQ96TAYDU	RXYQ120TAYDU	RXYQ144TAYDU	RXYQ168TAYDU	RXYQ192TAYDU	RXYQ216TAYDU	RXYQ240TAYDU	
Combination							1 x RXYQ120T 1 x RXYQ72T	1 x RXYQ120T 1 x RXYQ96T	2 x RXYQ120T	
Performance	Rated Cooling Capacity	BTU/h	69,000	92,000	114,000	138,000	158,000	184,000	206,000	228,000
	Rated Heating Capacity	BTU/h	73,000	103,000	129,000	154,000	174,000	206,000	230,000	256,000
	Sound Pressure	dB(A)	58	61		64	65	64		
	IEER (Ducted / Non-Ducted)		20.7 / 25.8	22.5 / 27.3	22.0 / 25.4	22.6 / 24.8	19.8 / 22.6	21.2 / 22.2	21.1 / 20.5	20.9 / 20.8
	Airflow	CFM	5,544	5,827	6,286	8,228		5,544 + 6,286	5,827 + 6,286	6,286 + 6,286
Fan ESP, Standard/Max	in. Wg	0.12 / 0.32								
Compressor	Compressors, all inverter	Qty	1			2				
	Revolutions per minute	RPM	7668	7650	7746	7008 + 7608	7680 + 8280	7668, 7746	7650, 7746	7746, 7746
	Capacity Control Range	%	20-100	16-100	15-100	11-100	10-100	17-100	15-100	
Refrigerant Piping, Layout	Maximum Vertical Pipe Length Above Unit	ft.	164 (295 With Field Setting)							
	Maximum Vertical Pipe Length Below Unit	ft.	130 (295 With Field Setting)							
	Maximum Vertical Pipe Length Between IDU	ft.	100							
	Maximum Actual Pipe Length	ft.	540							
	Maximum Equivalent Pipe Length	ft.	620							
Maximum Total Pipe Length	ft.	3,280								
Refrigerant Piping, Connections	Liquid Pipe, Main Line	in.	Ø3/8 (9.5) C1220T (Brazeing Connection)		Ø1/2 (12.7) C1220T (Brazeing Connection)		Ø5/8 (15.9) C1220T (Brazeing Connection)			
	Suction Gas Pipe, Main Line	in.	Ø3/4 (19.1) C1220T (Brazeing Connection)	Ø7/8 (22.2) C1220T (Brazeing Connection)	Ø1-1/8 (28.6) C1220T (Brazeing Connection)				Ø1-3/8 (34.9) C1220T (Brazeing Connection)	
Connection Ratio	Standard Connectable Indoor Unit Ratio	%	50 - 200							
	Maximum Number of Indoor Units	Qty	12	16	20	25	29	33	37	41
Electrical	Maximum Overcurrent Protection, MOP (RXYQ_TAT / RXYQ_TAY)	A	35 / 20	45 / 25		60 / 35	60 / 35	35 + 45 / 20 + 25	45 + 45 / 25+25	45 + 45 / 25 + 25
	Minimum Circuit Amps, MCA (RXYQ_TAT / RXYQ_TAY)	A	27.6 / 12.3	36.3 / 20.6	36.3 / 20.6	55.1 / 25.9	55.1 / 25.9	27.6 + 36.3 / 12.3 + 20.6	36.3 + 36.3 / 20.6 + 20.6	36.3 + 36.3 / 20.6 + 20.6
	Compressor Rated Load Amps, RLA (RXYQ_TAT / RXYQ_TAY)	A	15.7 / 7.1	23.8 / 10.2	26.2 / 11.7	16.7 + 16.7 / 7.6 + 7.6	18.8 + 18.8 / 8.5 + 8.5	15.7 + 26.2 / 7.1 + 11.7	23.8 + 26.2 / 10.2 + 11.7	26.2 + 26.2 / 11.7 + 11.7
Unit	Factory Refrigerant Charge	lbs.	13	22.7	22.9	18.1	17.2	13.0 + 22.9	22.7 + 22.9	22.9 + 22.9
	Weight (RXYQ_TAT / RXYQ_TAY)	lbs.	435 / 451	525 / 553	528 / 556	695 / 709		435 + 528 / 451 + 556	525 + 528 / 553 + 556	528 + 528 / 556 + 556
	Dimensions (H x W x D)	in.	66-11/16 x 36-11/16 x 30-3/16	66-11/16 x 48-7/8 x 30-3/16				66-11/16 x 48-7/8 x 30-3/16 + 66-11/16 x 36-11/16 x 30-3/16	(66-11/16 x 48-7/8 x 30-3/16) x 2	

### OPERATION RANGE FOR ALL VRV IV HEAT PUMP OUTDOOR UNITS

Cooling °F DB	10° – 122
Heating °F WB	-4 – 60

\*Application rules apply

	22 Ton	24 Ton	26 Ton	28 Ton	30 Ton	32 Ton	34 Ton
	RXYQ264TATJU	RXYQ288TATJU	RXYQ312TATJU	RXYQ336TATJU	RXYQ360TATJU	RXYQ384TATJU	RXYQ408TATJU
	RXYQ264TAYDU	RXYQ288TAYDU	RXYQ312TAYDU	RXYQ336TAYDU	RXYQ360TAYDU	RXYQ384TAYDU	RXYQ408TAYDU
	1 x RXYQ144T 1 x RXYQ120T	2 x RXYQ144T	1 x RXYQ168T 1 x RXYQ144T	2 x RXYQ168T	3 x RXYQ120T	1 x RXYQ168T 1 x RXYQ120T 1 x RXYQ96T	1 x RXYQ168T 1 x RXYQ144T 1 x RXYQ96T
	252,000	274,000	296,000	312,000	342,000	356,000	372,000
	282,000	308,000	334,000	342,000	372,000	396,000	435,000
	66	67	68		66	68	
	19.6 / 20.3	19.6 / 20.1	18.8 / 19.9	18.5 / 20.6	18.5 / 19.4	18.5 / 21.1	19.0 / 21.1
	6286 + 8228	8228 + 8228		6286 + 6286 + 6286		5827 + 6286 + 8228	6286 + 6286 + 8228
	0.12 / 0.32						
	3	4			3	4	5
	7746, (7008, 7608)	(7008, 7608), (7008, 7608)	(7008, 7608), (7680, 8280)	(7680, 8280), (7680, 8280)	7746, 7746, 7746	7650, 7746, (7680, 8280)	7650, (7008, 7608), (7680, 8280)
	13-100	11-100	10-100		15-100	13-100	12-100
	164 (295 With Field Setting)						
	131 (295 With Field Setting)						
	100						
	541						
	620						
	3,280						
	Ø3/4 (19.1) C1220T (Brazeing Connection)						
	Ø1-3/8 (34.9) C1220T (Brazeing Connection)				Ø1-5/8 (41.3) C1220T (Brazeing Connection)		
	50 - 200						
	45	49	54	58	62	64	
	45 + 60 / 25 + 35	60 + 60 / 35 + 35			45 + 45 + 45 / 25 + 25 + 25	45 + 45 + 60 / 25 + 25 + 35	45 + 60 + 60 / 25 + 35 + 35
	36.3 + 55.1 / 20.6 + 25.9	55.1 + 55.1 / 25.9 + 25.9			36.3 + 36.3 + 36.3 / 20.6 + 20.6 + 20.6	36.3 + 36.3 + 55.1 / 20.6 + 20.6 + 25.9	36.3 + 55.1 + 55.1 / 20.6 + 25.9 + 25.9
	26.2 + (16.7 + 16.7) / 11.7 + (7.6 + 7.6)	(16.7 + 16.7) x 2 / (7.6 + 7.6) x 2	(16.7 + 16.7) + (18.8 + 18.8) / (7.6 + 7.6) + (8.5 + 8.5)	(18.8 + 18.8) x 2 / (8.5 + 8.5) x 2	26.2 + 26.2 + 26.2 / 11.7 + 11.7 + 11.7	23.8 + 26.2 + (18.8 + 18.8) / 10.2 + 11.7 + (8.5 + 8.5)	23.8 + (16.7 + 16.37) + (18.8 + 18.8) / 10.2 + (7.6 + 7.6) + (8.5 + 8.5)
	22.9 + 18.1	18.1 + 18.1	18.1 + 17.2	17.2 + 17.2	22.9 + 22.9 + 22.9	22.7 + 22.9 + 17.2	22.7 + 18.1 + 17.2
	528 + 695 / 556 + 709	695 + 695 / 709 + 709			528 + 528 + 528 / 525 + 528 + 695	525 + 528 + 695 / 553 + 556 + 709	525 + 695 + 695 / 553 + 709 + 709
	(66-11/16 x 48-7/8 x 30-3/16) x 2				(66-11/16 x 48-7/8 x 30-3/16) x 3		

OUTDOOR UNITS

For additional technical information please refer to specific Engineering Data Books.

# VRV T-Series Water-Cooled Heat Pump / Heat Recovery 208-230V / 460V

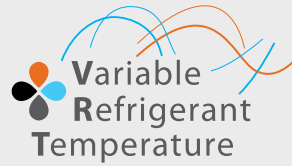

VRV T-Series Water-Cooled systems are equivalent to 4-pipe chilled water systems, but also offer a viable alternative to Water Source Heat Pump solutions. Each connected indoor unit can provide heating and cooling independently to suit zone requirements making these systems suitable for both open plan, or cellar applications with different operation requirements.

## Features and Benefits

- » Flexible System design with increased diversity up to 150%<sup>1</sup> compared to previous VRV water-cooled generation
- » Triple-stack capable to deliver up to 36 tons in 11.5 ft ceiling height
- » Flexible and easy installation with field selectable top or front refrigerant connections
- » Design flexibility with long piping lengths up to 980 ft. total (540 ft. max. linear liquid piping length) and up to 100 ft. vertical separation between indoor units
- » Engineered with heat rejection cancellation technology<sup>2</sup> to minimize mechanical room conditioning requirements
- » Year round comfort and energy efficiency by combining VRV and VRT technologies
- » Wide water temperature operation range - Can be applied to both geothermal and boiler/tower applications as standard with condenser water inlet temperature as low as 14°F in heating and 23°F in cooling is possible.
- » 2-9V variable water flow control logic<sup>2</sup> as standard to increase waterside system operational efficiencies
- » Refrigerant cooled inverter technology to deliver consistent and reliable PCB operations
- » Easy commissioning with ability to program settings off site using new configurator tool
- » 3-digit 7-segment digital display on the unit for improved and faster configuration, commissioning, and troubleshooting
- » Engineered for easy service with drop-down switch box to access key components

<sup>1</sup> Model specific, check product specification for details

<sup>2</sup> Refer to installation manual for field settings and other requirements to activate this feature



OUTDOOR UNITS

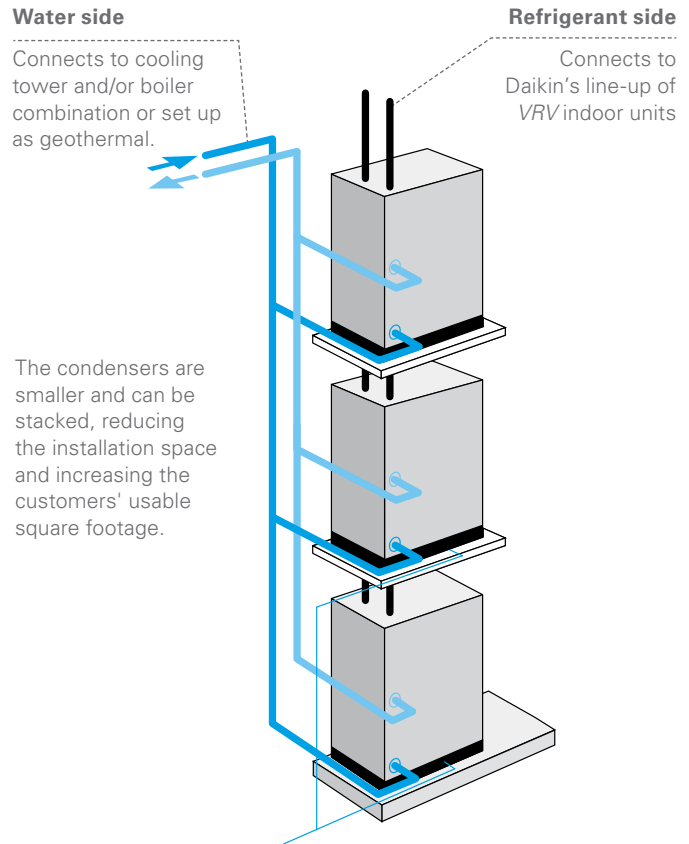

VRV Water-Cooled System Series design is based on a modular design concept. It is composed of unified condensing units that require simply connecting a two-pipe refrigerant network for heat pump applications or a three-pipe refrigerant network for heat recovery applications. Water-cooled condensers are available in 6\*, 8, 10 and 12 tons.

This is a simple system that allows manifolding together up to three condensers to form one system of up to 36 tons. The condensers are designed for internal mounting only.

\* 6-ton model (RWEYQ72PC) is PC series. T and PC series models cannot be combined to form multi-module systems.

**VRV T-SERIES WATER-COOLED CERTIFIED DATA, 208-230V/60HZ/3PH AND 460V/60HZ/3PH**

Function	System Name	Tonnage	IEER Non-Ducted	IEER Ducted	IEER Mixed	SCHE Non-Ducted (Heat-Recovery only)	SCHE Ducted (Heat-Recovery only)	SCHE Mixed (Heat-Recovery only)	EER Non-Ducted	EER Ducted	EER Mixed	COP @68°F Non-Ducted	COP @68°F Ducted	COP @68°F Mixed
Heat Pump	RWEYQ72PC	6 Tons	24.1	22.3	23.2	N/A	N/A	N/A	14.0	14.0	14.0	4.89	4.78	4.84
	RWEQ96T	8 Tons	30.8	25.4	28.1	N/A	N/A	N/A	19.6	15.4	17.5	6.27	5.8	6.035
	RWEQ120T	10 Tons	29.4	23.5	26.45	N/A	N/A	N/A	16	13.6	14.8	6.1	5.55	5.83
	RWEQ144T	12 Tons	24.3	19.8	22.05	N/A	N/A	N/A	15.4	12.6	14.0	6.01	5.33	5.67
	RWEQ192T	16 Tons	26.8	24.7	25.75	N/A	N/A	N/A	16.5	14.6	15.55	5.82	5.82	5.82
	RWEQ216T	18 Tons	26.3	23.8	25.05	N/A	N/A	N/A	15.0	13.8	14.4	5.68	5.62	5.65
	RWEQ240T	20 Tons	25.7	22.7	24.2	N/A	N/A	N/A	14.0	12.8	13.4	5.52	5.38	5.45
	RWEQ264T	22 Tons	23.5	2.00	21.75	N/A	N/A	N/A	13.5	12.1	12.8	5.34	4.96	5.15
	RWEQ288T	24 Tons	20.9	18.8	19.85	N/A	N/A	N/A	12.6	11.3	11.95	5.3	4.81	5.06
	RWEQ312T	26 Tons	21.9	21.8	21.85	N/A	N/A	N/A	13.7	12.7	13.2	5.5	4.86	5.18
	RWEQ336T	28 Tons	21.5	21.4	21.45	N/A	N/A	N/A	13.5	12.3	12.9	5.42	4.73	5.08
	RWEQ360T	30 Tons	21.2	20.2	20.7	N/A	N/A	N/A	12.4	11.7	12.05	5.3	4.7	5.0
	RWEQ384T	32 Tons	19.5	17.9	18.7	N/A	N/A	N/A	12	11	11.5	4.53	4.12	4.33
RWEQ408T	34 Tons	18.2	17.2	17.7	N/A	N/A	N/A	11.1	10.7	10.9	4.35	4.03	4.19	
RWEQ432T	36 Tons	17.0	16.6	16.8	N/A	N/A	N/A	10.5	10.3	10.4	4.19	3.92	4.06	
Heat-Recovery	RWEYQ72PC	6 Tons	24.1	22.3	23.2	17.8	19.2	18.5	14.0	14.0	14.0	4.89	4.78	4.84
	RWEQ96T	8 Tons	30.8	25.4	28.1	25.7	21.3	23.5	19.6	15.4	17.5	6.27	5.8	6.035
	RWEQ120T	10 Tons	29.4	23.5	26.45	26.3	22.5	24.4	16	13.6	14.8	6.1	5.55	5.83
	RWEQ144T	12 Tons	24.3	19.8	22.05	26.5	22.7	24.6	15.4	12.6	14	6.01	5.33	5.67
	RWEQ192T	16 Tons	26.8	24.7	25.75	26.0	22.9	24.45	16.5	14.6	15.55	5.82	5.82	5.82
	RWEQ216T	18 Tons	26.3	23.8	25.05	25.5	22.1	23.8	15.0	13.8	14.4	5.68	5.62	5.65
	RWEQ240T	20 Tons	25.7	22.7	24.2	25.4	21.9	23.65	14.0	12.8	13.4	5.52	5.38	5.45
	RWEQ264T	22 Tons	23.5	2.00	21.75	25.2	19.2	22.2	13.5	12.1	12.8	5.34	4.96	5.15
	RWEQ288T	24 Tons	20.9	18.8	19.85	23.5	20.0	21.75	12.6	11.3	11.95	5.3	4.81	5.06
	RWEQ312T	26 Tons	21.9	21.8	21.85	24.5	20.7	22.6	13.7	12.7	13.2	5.5	4.86	5.18
	RWEQ336T	28 Tons	21.5	21.4	21.45	23.5	20.0	21.75	13.5	12.3	12.9	5.42	4.73	5.08
	RWEQ360T	30 Tons	21.2	20.2	20.7	23.2	19.1	21.15	12.4	11.7	12.05	5.3	4.7	5.0
	RWEQ384T	32 Tons	19.5	17.9	18.7	22.0	19.1	20.55	12.0	11.0	11.5	4.53	4.12	4.33
RWEQ408T	34 Tons	18.2	17.2	17.7	21.2	18.5	19.85	11.1	10.7	10.9	4.35	4.03	4.19	
RWEQ432T	36 Tons	17.0	16.6	16.8	20.5	17.7	19.1	10.5	10.3	10.4	4.19	3.92	4.055	

Certified efficiency data in accordance with ANSI/AHRI Standard 1230 2014, "Performance Rating of Variable Refrigerant Flow Multi-Split Air Conditioning and Heat Pump Equipment" for the VRV T-Series Water-Cooled. The VRV T-Series Water-Cooled has been designed and optimized to meet or exceed the latest minimum efficiency requirements in 10 C.F.R. Part 431 as determined by the U.S. Department of Energy (DOE) and baseline efficiencies as defined by ASHRAE 90.1 2016. Systems under 65MBH are currently certified to AHRI 210/240. IEER ratings are as defined in ASHRAE 90.1 2016.

**OUTDOOR UNITS**

**DETAILED STANDARD OPERATION RANGES FOR VRV T-SERIES WATER-COOLED CONDENSING UNITS**

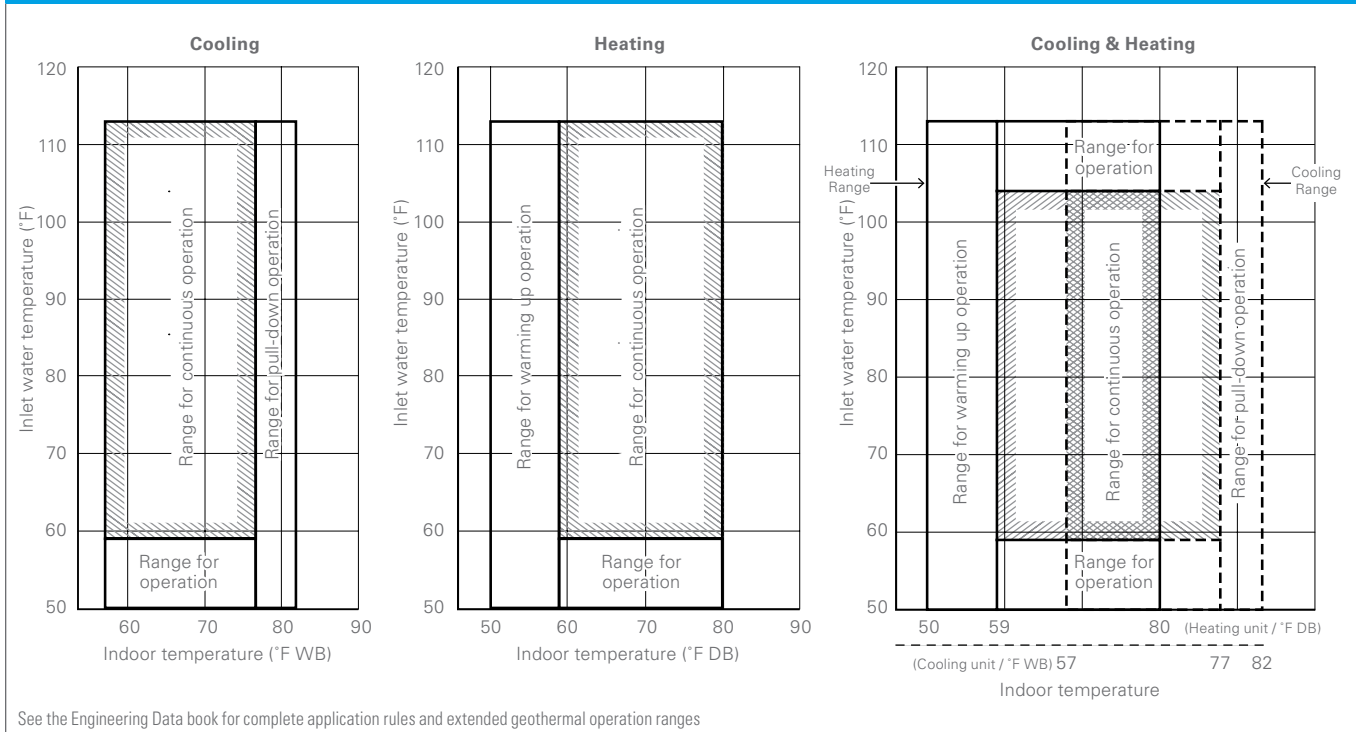

# VRV T-Series Water-Cooled Heat Pump or Heat Recovery 208-230V

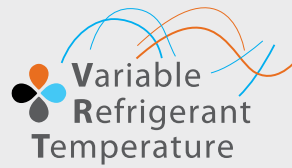

A modular, energy-efficient and reliable alternative to centralized equipment

## Features and Benefits

- » Flexible System design with increased diversity up to 150%<sup>1</sup> compared to previous VRV water-cooled generation
- » Small condensers can be triple stacked for reduced installation space and increased usable square footage
- » Larger (than previous models) single-system capacity and modular concept ensures wider application range for accommodating floor-by-floor loads of commercial buildings
- » Year round comfort and energy efficiency by combining VRV and VRT technologies

- » Can be applied to both geothermal and boiler/tower applications as standard with condenser water inlet temperature as low as 14 °F in heating and 23 °F in cooling is possible
- » 2-9V variable water flow control logic<sup>2</sup> as standard to increase waterside system operational efficiencies
- » Refrigerant cooled inverter technology to deliver consistent and reliable PCB operations
- » Engineered for easy service with drop-down switch box to access key components

<sup>1</sup> Model specific, check product specification for details

<sup>2</sup> Refer to installation manual for field settings and other requirements to activate this feature

VRV T-SERIES WATER-COOLED UNIFIED HEAT PUMP AND HEAT RECOVERY																
Model	Name Combination	6 Ton		8 Ton		10 Ton		12 Ton		16 Ton		18 Ton		20 Ton		
		RWEQ72PCTJ <sup>1</sup>	RWEQ96TATJU	RWEQ120TATJU	RWEQ144TATJU	RWEQ192TATJU	RWEQ216TATJU	RWEQ240TATJU	2 x RWEQ96TATJU	RWEQ96TATJU RWEQ120TATJU	2 x RWEQ120TATJU					
Performance	Rated Cooling Capacity <sup>2</sup>	BTU/h	69,000	92,000	114,000	138,000	184,000	206,000	228,000							
	Rated Heating Capacity <sup>3</sup>	BTU/h	77,000	103,000	129,000	154,000	206,000	232,000	258,000							
	Power	V/ph/Hz	208-230/3/60													
	Sound Pressure Level @ 3 ft.	dB(A)	50	54	55	60.5	57	57.5	58							
Refrigerant Piping	System Configuration: Heat Pump: HP, Heat Recovery: HR		HP	HR	HP	HR	HP	HR	HP	HR	HP	HR	HP	HR	HP	HR
	Liquid Pipe (Main Line)	in.	3/8	3/8	3/8	3/8	1/2	1/2	1/2	1/2	5/8	5/8	5/8	5/8	5/8	5/8
	Suction Gas Pipe (Main Line)	in.	3/4	5/8	7/8	3/4	1-1/8	3/4	1-1/8	7/8	1-1/8	1-1/8	1-1/8	1-1/8	1-3/8	1-1/8
	Discharge Gas Pipe (Main Line)	in.	N/A	3/4	N/A	7/8	N/A	1-1/8	N/A	1-1/8	N/A	1-1/8	N/A	1-1/8	N/A	1-3/8
	Vertical Pipe Length (if unit is below FCU)	ft.	164 (130)		164 (130)											
	Actual Pipe Length (Equivalent Length)	ft.	390 (459)		540 (623)											
	Total Pipe Length	ft.	980		980											
Connection Ratio	Standard Connectable Indoor Unit Ratio	%	50 - 130		50 - 150 <sup>4</sup>											
	Maximum Number of Indoor Units	Qty.	12		16		20		25		33		37		41	
Water Side (Standard)	BPHE Inlet Pipe (Female Thread)	in.	1-1/4		1-1/4		1-1/4		1-1/4		2 x 1-1/4		2 x 1-1/4		2 x 1-1/4	
	BPHE Outlet Pipe (Female Thread)	in.	1-1/4		1-1/4		1-1/4		1-1/4		2 x 1-1/4		2 x 1-1/4		2 x 1-1/4	
	Drain Pipe (Female Thread)	in.	1/2		3/8		3/8		3/8		2 x 3/8		2 x 3/8		2 x 3/8	
	Maximum System Water Pressure (BPHE)	psi	285		464											
	Standard Inlet Water Temperature Range Cooling	°F	50 - 113													
	Standard Inlet Water Temperature Range Heating	°F	50 - 113													
Water Side (Geothermal)	Recommended Inlet Water Flow Rate per Module (minimum) <sup>5</sup>	gpm	13.2 ~ 39.6													
	Inlet Water Temperature Range Cooling <sup>5</sup>	°F	27 - 113		23 - 113											
	Inlet Water Temperature Range Heating <sup>5</sup>	°F	14 - 95		14 - 95											
Unit	Water Flow Rate <sup>5</sup>	gpm	21.2 - 39.6		21.2 - 39.6											
	Weight	lbs.	330		419		423		423		2 x 419		419 + 423		2 x 423	
Electrical	Dimensions (H x W x D)	in.	39-3/8 x 30-3/4 x 21-11/16		38-9/16 x 30-1/8 x 22-1/16					38-9/16 x (30-1/8 x 2) x 22-1/16						
	Voltage Range (min - max)	V	187 - 253													
	Maximum Overcurrent Protection (MOP)	A	30		35		45		50		35 + 35		35 + 45		45 + 45	
	Minimum Circuit Amps (MCA)	A	22.4		28.8		36.5		44.6		28.8 + 28.8		28.8 + 36.5		36.5 + 36.5	
Compressor	Compressor Rated Load Amps (RLA)	A	11.6		19		20.9		29.4		19 + 19		19 + 20.9		20.9 + 20.9	
	Compressor Type		Daikin G-Type Scroll		Daikin K-Type Scroll											
	Compressor Set-Up				1 INV					1 INV + 1 INV						
Compressor Capacity Control		%	23 - 100		16 - 100		14 - 100		11 - 100		8 - 100		8 - 100		7 - 100	

<sup>1</sup>Some features and benefits may not be available for this model. Please contact your local Daikin sales representative for more details.

<sup>2</sup>Indoor temp.: 80°FDB, 67°FWB/inlet water temp.: 85°F/ Equivalent piping length: 25 ft., level difference: 0 ft.

<sup>3</sup>Indoor temp.: 70°FDB, 60°FWB/inlet water temp.: 70°F / Equivalent piping length: 25 ft., level difference: 0 ft.





RWEQ\_TATJU/TAYDU

OUTDOOR UNITS

22 Ton		24 Ton		26 Ton		28 Ton		30 Ton		32 Ton		34 Ton		36 Ton	
RWEQ264TATJU		RWEQ288TATJU		RWEQ312TATJU		RWEQ336TATJU		RWEQ360TATJU		RWEQ384TATJU		RWEQ408TATJU		RWEQ432TATJU	
RWEQ120TATJU RWEQ144TATJU		2 x RWEQ144TATJU		2 x RWEQ96TATJU RWEQ120TATJU		RWEQ96TATJU 2 x RWEQ120TATJU		3 x RWEQ120TATJU		2 x RWEQ120TATJU RWEQ144TATJU		RWEQ120TATJU 2 x RWEQ144TATJU		3 x RWEQ144TATJU	
252,000		274,000		298,000		320,000		342,000		366,000		388,000		410,000	
284,000		308,000		334,000		360,000		386,000		410,000		435,000		460,000	
208-230/3/60															
61.5		63.5		59		59.5		60		62		64		65	
HP	HR	HP	HR	HP	HR	HP	HR	HP	HR	HP	HR	HP	HR	HP	HR
3/4	3/4	3/4	3/4	3/4	3/4	3/4	3/4	3/4	3/4	3/4	3/4	3/4	3/4	3/4	3/4
1-3/8	1-1/8	1-3/8	1-1/8	1-3/8	1-1/8	1-3/8	1-1/8	1-5/8	1-3/8	1-5/8	1-3/8	1-5/8	1-3/8	1-5/8	1-3/8
N/A	1-3/8	N/A	1-3/8	N/A	1-3/8	N/A	1-3/8	N/A	1-5/8	N/A	1-5/8	N/A	1-5/8	N/A	1-5/8
164 (130)															
540 (623)															
980															
50 - 150 <sup>4</sup>															
45		49		54		58		62		64		64		64	
2 x 1-1/4		2 x 1-1/4		3 x 1-1/4		3 x 1-1/4		3 x 1-1/4		3 x 1-1/4		3 x 1-1/4		3 x 1-1/4	
2 x 1-1/4		2 x 1-1/4		3 x 1-1/4		3 x 1-1/4		3 x 1-1/4		3 x 1-1/4		3 x 1-1/4		3 x 1-1/4	
2 x 3/8		2 x 3/8		3 x 3/8		3 x 3/8		3 x 3/8		3 x 3/8		3 x 3/8		3 x 3/8	
464															
50 - 113															
50 - 113															
13.2 - 39.6															
23 - 113															
14 - 95															
21.2 - 39.6															
2 x 423		2 x 423		2 x 419 + 423		419 + 2 x 423		3 x 423		3 x 423		3 x 423		3 x 423	
38-9/16 x (30-1/8 x 2) x 22-1/16				38-9/16 x (30-1/8 x 3) x 22-1/16											
187 - 253															
45 + 50		50 + 50		35 + 35 + 45		35 + 45 + 45		45 + 45 + 45		45 + 45 + 50		45 + 50 + 50		50 + 50 + 50	
36.5 + 44.6		44.6 + 44.6		28.8 + 28.8 + 36.5		28.8 + 36.5 + 36.5		36.5 + 36.5 + 36.5		36.5 + 36.5 + 44.6		36.5 + 44.6 + 44.6		44.6 + 44.6 + 44.6	
20.9 + 29.4		29.4 + 29.4		19 + 19 + 20.9		19 + 20.9 + 20.9		20.9 + 20.9 + 20.9		20.9 + 20.9 + 29.4		20.9 + 29.4 + 29.4		29.4 + 29.4 + 29.4	
Daikin K-Type Scroll															
1 INV + 1 INV				1 INV + 1 INV + 1 INV											
6 - 100		5 - 100		5 - 100		5 - 100		5 - 100		4 - 100		4 - 100		4 - 100	

<sup>4</sup>Varies based on indoor and condensing unit model selected; refer to Engineering Manual for details.

<sup>5</sup>Please note that a water strainer (standard accessory for the T-series, field supplied for the PC-series) is required for each condensing unit model.

<sup>6</sup>Application rules apply below 50°F. Please contact your local Daikin sales representative for design assistance and approval.

# VRV T-Series Water-Cooled Heat Pump or Heat Recovery 460V

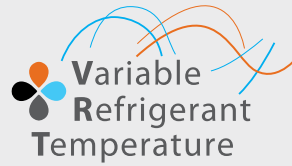

A modular, energy-efficient and reliable alternative to centralized equipment

## Features and Benefits

- » Flexible System design with increased diversity up to 150%<sup>1</sup> compared to previous VRV water-cooled generation
- » Small condensers can be triple stacked for reduced installation space and increased usable square footage
- » Larger (than previous models) single-system capacity and modular concept ensures wider application range for accommodating floor-by-floor loads of commercial buildings
- » Year round comfort and energy efficiency by combining VRV and VRT technologies
- » Can be applied to both geothermal and boiler/tower applications as standard with condenser water inlet temperature as low as 14 °F in heating and 23 °F in cooling is possible
- » 2-9V variable water flow control logic<sup>2</sup> as standard to increase waterside system operational efficiencies
- » Refrigerant cooled inverter technology to deliver consistent and reliable PCB operations
- » Engineered for easy service with drop-down switch box to access key components

<sup>1</sup> Model specific, check product specification for details

<sup>2</sup> Refer to installation manual for field settings and other requirements to activate this feature

### VRV T-SERIES WATER-COOLED UNIFIED HEAT PUMP AND HEAT RECOVERY

		6 Ton		8 Ton		10 Ton		12 Ton		16 Ton		18 Ton		20 Ton		
Model	Name	RWEQ72PCYD <sup>1</sup>		RWEQ96TAYDU		RWEQ120TAYDU		RWEQ144TAYDU		RWEQ192TAYDU		RWEQ216TAYDU		RWEQ240TAYDU		
	Combination									2x RWEQ96TAYDU		RWEQ96TAYDU RWEQ120TAYDU		2x RWEQ120TAYDU		
Performance	Rated Cooling Capacity <sup>2</sup>	BTU/h	69,000		92,000		114,000		138,000		184,000		206,000		228,000	
	Rated Heating Capacity <sup>3</sup>	BTU/h	77,000		103,000		129,000		154,000		206,000		232,000		258,000	
	Power	V/ph/Hz	460/3/60													
	Sound Pressure Level @ 3 ft.	dB(A)	50		54		55		60.5		57		57.5		58	
Refrigerant Piping	System Configuration: Heat Pump: HP, Heat Recovery: HR		HP	HR	HP	HR	HP	HR	HP	HR	HP	HR	HP	HR	HP	HR
	Liquid Pipe (Main Line)	in.	3/8	3/8	3/8	3/8	1/2	1/2	1/2	1/2	5/8	5/8	5/8	5/8	5/8	5/8
	Suction Gas Pipe (Main Line)	in.	3/4	5/8	7/8	3/4	1-1/8	3/4	1-1/8	7/8	1-1/8	1-1/8	1-1/8	1-1/8	1-3/8	1-1/8
	Discharge Gas Pipe (Main Line)	in.	N/A	3/4	N/A	7/8	N/A	1-1/8	N/A	1-1/8	N/A	1-1/8	N/A	1-1/8	N/A	1-3/8
	Vertical Pipe Length (if unit is below FCU)	ft.	164 (130)				164 (130)									
	Actual Pipe Length (Equivalent Length)	ft.	390 (459)				540 (623)									
	Total Pipe Length	ft.	980				980									
Connection Ratio	Standard Connectable Indoor Unit Ratio	%	50 - 130				50 - 150 <sup>4</sup>									
	Maximum Number of Indoor Units	Qty.	12		16		20		25		33		37		41	
Water Side (Standard)	BPHE Inlet Pipe (Female Thread)	in.	1-1/4		1-1/4		1-1/4		1-1/4		2 x 1-1/4		2 x 1-1/4		2 x 1-1/4	
	BPHE Outlet Pipe (Female Thread)	in.	1-1/4		1-1/4		1-1/4		1-1/4		2 x 1-1/4		2 x 1-1/4		2 x 1-1/4	
	Drain Pipe (Female Thread)	in.	1/2		3/8		3/8		3/8		2 x 3/8		2 x 3/8		2 x 3/8	
	Maximum System Water Pressure (BPHE)	psi	285				536.6									
	Standard Inlet Water Temperature Range Cooling	°F	50 - 113													
	Standard Inlet Water Temperature Range Heating	°F	50 - 113													
Recommended Inlet Water Flow Rate per Module (minimum) <sup>5</sup>	gpm	13.2 - 39.6														
Water Side (Geothermal)	Inlet Water Temperature Range Cooling <sup>6</sup>	°F	27 - 113				23 - 113									
	Inlet Water Temperature Range Heating <sup>6</sup>	°F	14 - 113				14 - 95									
	Water Flow Rate <sup>5</sup>	gpm	21.2 - 39.6				21.2 - 39.6									
Unit	Weight	lbs.	343		426		430		430		2 x 426		426 + 430		2 x 430	
	Dimensions (H x W x D)	in.	39-3/8 x 30-3/4 x 21-11/16		38-9/16 x 30-1/8 x 22-1/16						38-9/16 x (30-1/8 x 2) x 22-1/16					
Electrical	Voltage Range (min - max)	V	414 - 506													
	Maximum Overcurrent Protection (MOP)	A	15		15		20		25		15 + 15		15 + 20		20 + 20	
	Minimum Circuit Amps (MCA)	A	10.2		13		16.5		20.2		13 + 13		13 + 16.5		16.5 + 16.5	
	Compressor Rated Load Amps (RLA)	A	5.3		8.6		9.4		13.3		8.6 + 8.6		8.6 + 9.4		9.4 + 9.4	
Compressor	Compressor Type		Daikin G-Type Scroll				Daikin K-Type Scroll									
	Compressor Set-Up		1 INV													
	Compressor Capacity Control	%	23 - 100		16 - 100		14 - 100		11 - 100		8 - 100		8 - 100		7 - 100	

<sup>1</sup>Some features and benefits may not be available for this model. Please contact your local Daikin sales representative for more details.

<sup>2</sup>Indoor temp.: 80°FDB, 67°FWB/inlet water temp.: 85°F / Equivalent piping length : 25 ft., level difference : 0 ft.

<sup>3</sup>Indoor temp.: 70°FDB, 60°FWB/inlet water temp.: 70°F / Equivalent piping length: 25 ft., level difference : 0 ft.

RWEQ\_TATJU/TAYDU



OUTDOOR UNITS

22 Ton		24 Ton		26 Ton		28 Ton		30 Ton		32 Ton		34 Ton		36 Ton	
RWEQ264TAYDU	RWEQ288TAYDU	RWEQ312TAYDU	RWEQ336TAYDU	RWEQ360TAYDU	RWEQ384TAYDU	RWEQ408TAYDU	RWEQ432TAYDU								
RWEQ120TAYDU RWEQ144TAYDU	2 x RWEQ144TAYDU	2 x RWEQ96TAYDU RWEQ120TAYDU	RWEQ96TAYDU 2 x RWEQ120TAYDU	3 x RWEQ120TAYDU	2 x RWEQ120TAYDU RWEQ144TAYDU	2 x RWEQ120TAYDU	3 x RWEQ144TAYDU								
252,000	274,000	298,000	320,000	342,000	366,000	388,000	410,000								
284,000	308,000	334,000	360,000	386,000	410,000	435,000	460,000								
460/3/60															
61.5		63.5		59		59.5		60		62		64		65	
HP	HR	HP	HR	HP	HR	HP	HR	HP	HR	HP	HR	HP	HR	HP	HR
3/4	3/4	3/4	3/4	3/4	3/4	3/4	3/4	3/4	3/4	3/4	3/4	3/4	3/4	3/4	3/4
1-3/8	1-1/8	1-3/8	1-1/8	1-3/8	1-1/8	1-3/8	1-1/8	1-5/8	1-3/8	1-5/8	1-3/8	1-5/8	1-3/8	1-5/8	1-3/8
N/A	1-3/8	N/A	1-3/8	N/A	1-3/8	N/A	1-3/8	N/A	1-5/8	N/A	1-5/8	N/A	1-5/8	N/A	1-5/8
164 (130)															
540 (623)															
980															
50 - 150 <sup>a</sup>															
45		49		54		58		62		64		64		64	
2 x 1-1/4		2 x 1-1/4		3 x 1-1/4		3 x 1-1/4		3 x 1-1/4		3 x 1-1/4		3 x 1-1/4		3 x 1-1/4	
2 x 1-1/4		2 x 1-1/4		3 x 1-1/4		3 x 1-1/4		3 x 1-1/4		3 x 1-1/4		3 x 1-1/4		3 x 1-1/4	
2 x 3/8		2 x 3/8		3 x 3/8		3 x 3/8		3 x 3/8		3 x 3/8		3 x 3/8		3 x 3/8	
536.6															
50 - 113															
50 - 113															
13.2 ~ 39.6															
23 - 113															
14 - 95															
21.2 - 39.6															
2 x 430		2 x 430		2 x 426 + 430		426 + 2 x 430		3 x 430		3 x 430		3 x 430		3 x 430	
38-9/16 x (30-1/8 x 2) x 22-1/16				38-9/16 x (30-1/8 x 3) x 22-1/16											
414 - 506															
20 + 25		25 + 25		15 + 15 + 20		15 + 20 + 20		20 + 20 + 20		20 + 20 + 25		20 + 25 + 25		25 + 25 + 25	
16.5 + 20.2		20.2 + 20.2		13 + 13 + 16.5		13 + 16.5 + 16.5		16.5 + 16.5 + 16.5		16.5 + 16.5 + 20.2		16.5 + 20.2 + 20.2		20.2 + 20.2 + 20.2	
9.4 + 13.3		13.3 + 13.3		8.6 + 8.6 + 9.4		8.6 + 9.4 + 9.4		9.4 + 9.4 + 9.4		9.4 + 9.4 + 13.3		9.4 + 13.3 + 13.3		13.3 + 13.3 + 13.3	
Daikin K-Type Scroll															
1 INV + 1 INV				1 INV + 1 INV + 1 INV											
6 - 100		5 - 100		5 - 100		5 - 100		5 - 100		4 - 100		4 - 100		4 - 100	

<sup>a</sup>Varies based on indoor and condensing unit model selected; refer to Engineering Manual for details.

<sup>b</sup>Please note that a water strainer (standard accessory for the T-series, field supplied for the PC-series) is required for each condensing unit model.

<sup>c</sup>Application rules apply below 50°F. Please contact your local Daikin sales representative for design assistance and approval.

# VRV IV S-Series Heat Pump 208-230V

## Light Commercial

The VRV IV S-series system is a highly efficient solution for small commercial buildings requiring heating and cooling of up to 9 zones. A mix of ducted and duct-free indoor units can be combined to provide individual comfort and ease of installation.

Whether you are working with space constraints or want to maximize the amount of commercial space available, the VRV IV S-series system gives you the flexibility you need. With its simple, versatile design and long piping (up to 230 ft. actual piping length one way), the VRV IV S-series can accommodate practically any floor layout, enabling better use of space.

Its advanced zoning capabilities allow floor-by-floor installation so that each floor can be occupied quickly upon completion. And, because the outdoor units are lightweight and vibration-free, there's no need to reinforce floors, reducing both installation time and costs.

Daikin VRV's wide range of stylish and discreet indoor units provide configurations for every retail space, giving you the benefit of our highly efficient technology, whatever the design of your store. Wall mounted units matched to your interior meet both aesthetic and energy needs while also supporting the look and feel of your brand and preserving floor space. Slim ducted and concealed units blend almost unseen into your store, while floor standing units with small footprints preserve floor space, fitting unobtrusively into recesses or under windows.

## Features and Benefits

- » Single-phase technology is perfect for light commercial and residential applications in 36,000, 48,000 and 60,000 Btu/h models.
- » Space-saving design to fit in tight areas and realize quick and easy installation.
- » Savings in energy use due to higher SEER and HSPF ratings when compared to VRV III-S.
- » Soft sound level operation ensures a comfortable fit in any room.
- » Single-supplier reliability. The system — factory engineered and 80% complete upon delivery — is fully optimized by Daikin, plus has self-diagnostics and one of the best warranties in the industry\*.
- » Simplified equipment selection with a flexible array of indoor unit options.

\* Complete warranty details available from your local Daikin manufacturer's representative or distributor or online at [www.daikincomfort.com](http://www.daikincomfort.com).



Retail



Restaurant



Apartments/Condos



CERTIFIED PERFORMANCE DATA									
Model Number	Indoor Units Combination	Nominal Cooling Capacity (BTU/h)	EER 95F	SEER	Nominal Heating Capacity (BTU/h)	Heating COP @ 47 °F	Low Heating Capacity (BTU/h)	Heating COP @ 17 °F	HSPF
RXTQ36TAVJ9	Non-Ducted Indoor Units	36,000	12.0	18.0	40,000	4.10	23,600	3.0	10.3
	Ducted Indoor Units	36,000	10.0	16.0	40,000	3.30	22,000	2.5	9.0
	Mixed Ducted and Non-Ducted Indoor Units	36,000	11.0	17.0	40,000	3.70	22,800	2.8	9.7
RXTQ48TAVJU	Non-Ducted Indoor Units	48,000	10.3	18.0	52,000	4.00	32,200	3.0	10.0
	Ducted Indoor Units	48,000	9.4	16.0	52,000	3.35	32,000	2.7	9.0
	Mixed Ducted and Non-Ducted Indoor Units	48,000	9.85	17.0	52,000	3.68	32,100	2.9	9.5
RXTQ60TAVJU	Non-Ducted Indoor Units	57,500	9.8	18.0	57,500	4.30	37,000	3.2	10.5
	Ducted Indoor Units	57,500	9.2	16.0	57,500	3.70	34,000	2.7	10.5
	Mixed Ducted and Non-Ducted Indoor Units	57,500	9.5	17.0	57,500	4.00	35,500	3.0	10.5

VRV IV-S SERIES						
	Model Name		RXTQ36TAVJ9	RXTQ48TAVJU	RXTQ60TAVJU	
	ODU Style	Fan Type	Single Fan	Single Fan	Double Fan	
Performance	Nominal Cooling Capacity	BTU/h	36,000	48,000	57,500	
	Nominal Heating Capacity	BTU/h	40,000	52,000	57,500	
	Operation Range Cooling	°F DB	23 to 122			
	Operation Range Heating	°F WB	-4 to 60			
	Power	V/p/Hz	208-230/1/60			
	Sound Pressure Level @ 3ft	dB(A)	58		57	
Refrigerant Piping	Refrigerant		R-410A			
	Refrigerant Quantity	lbs.	6.4	7.5	7.9	
	Liquid Pipe (Main Line)	in.	3/8			
	Suction Gas Pipe (Main Line)	in.	5/8		3/4	
	Vertical Pipe Length	ft.	98			
	Maximum vertical pipe length between IDU	ft.	33	49		
	Actual Pipe Length (Equivalent Length)	ft.	164	230		
	Total Piping Length	ft.	820	984		
Connection Ratio	Connectable Indoor Unit Ratio	%	50-130			
	Number of Indoor Units	Qty	6	8	9	
Unit	Outdoor Unit Size	(HxWxD)	39 x 37 x 12-5/8	39 x 37 x 12-5/8	52-15/16 x 35-7/16 x 12-5/8	
	Weight	lbs.	172	176	225	
Fan	Airflow	CFM	2682		3741	
	Fan Motor Output and Quantity	kW	0.20 x 1		0.070 X 2	
Electrical	Maximum Over Current Protection (MOP)	A	25	35		
	Minimum Circuit Amps (MCA)	A	17	29		
	Rated Load Amps (RLA)	A	15.3	19.0	23.2	
Compressor	Compressor Type	Type	Daikin Swing			
	Capacity Control	%	14-100			

OUTDOOR UNITS

**DETAILED OPERATION RANGES FOR VRV IV-S (RXTQ\_TAVJU) HEAT PUMP OUTDOOR UNITS**

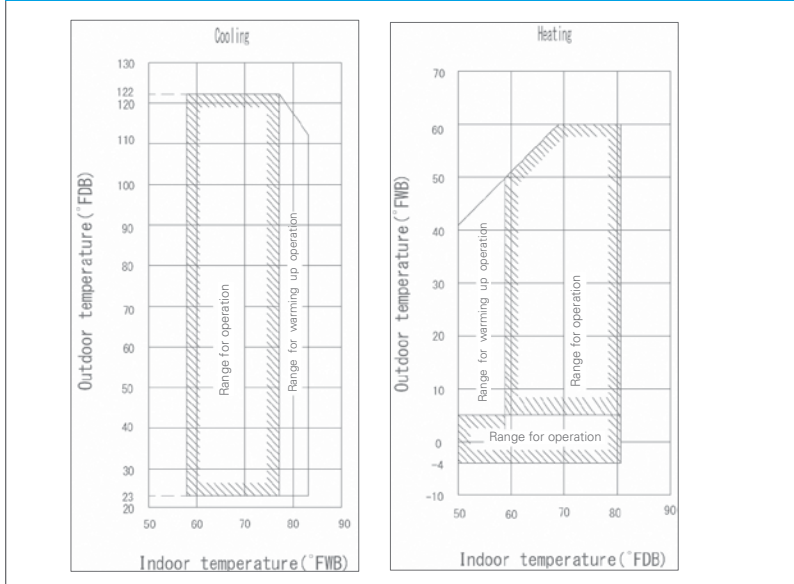

# VRV IV X, VRV IV, VRVT-Series Water-Cooled & VRV IV S-Series Installation Space

## VRV IV X / VRV IV / VRV AURORA™

### Installation Space Examples

- » The installation space requirement shown in the figure is a reference for cooling.
- » During installation, install the units using the most appropriate of the patterns shown in the figure for the location in question, taking into consideration human traffic and wind.
- » If the number of units installed is more than that shown in the pattern in the figure, install the units so that there is no air short circuiting.
- » Consider the space needed for the refrigerant piping when installing the units, as determined by local codes.
- » If the space requirements in the figure do not apply, contact your contractor or Daikin directly.

For single unit installation

< Pattern 1 >

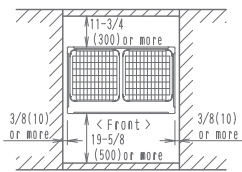

< Pattern 2 >

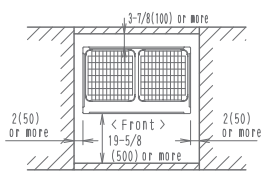

< Pattern 3 >

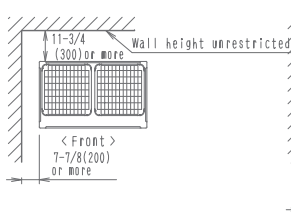

For installation in rows

< Pattern 1 >

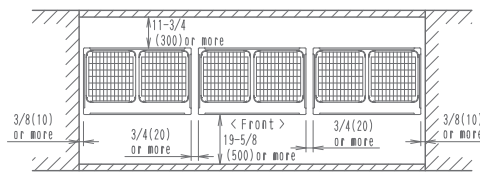

< Pattern 2 >

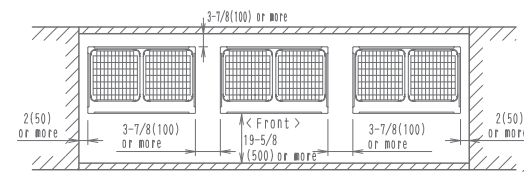

< Pattern 3 >

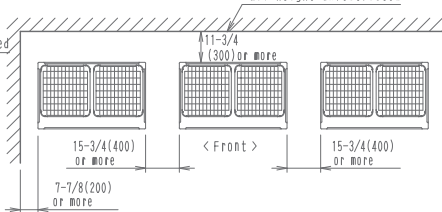

For centralized group layout

< Pattern 1 >

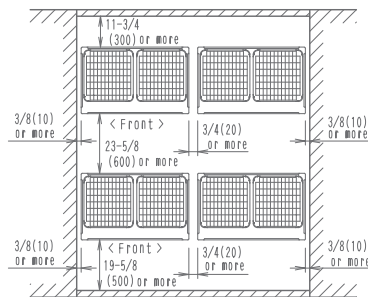

< Pattern 2 >

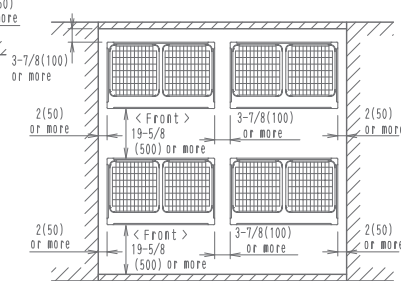

### Notes

1. Heights of walls in case of Patterns 1 and 2:  
Front: 59in  
Suction side: 19-5/8in  
Side: Height unrestricted.  
Installation space shown in this drawing is based on the cooling operation at 95°F outdoor air temperature. When the design outdoor temperature exceeds 95°F or the load exceeds maximum ability because of much generation load of heat in all outdoor unit, take the suction-side space more broadly than the space shown in this drawing.
2. If the above wall heights are exceeded then h<sub>2</sub>/2 and h<sub>1</sub>/2 should be added to the front and suction side service spaces respectively as shown in the figure.

3. When installing, the units most appropriate pattern should be selected in order to obtain the best fit in the space available, always bearing in mind the need to leave enough space for a person to pass between the units and wall and for the air to circulate freely.
4. The units should be installed to leave sufficient space at the front for the field refrigerant piping work to be carried out comfortably.

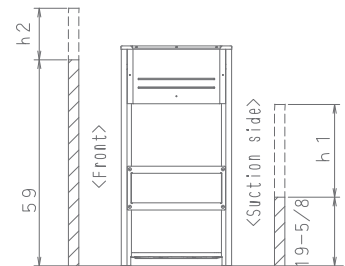



T-Series Water Cooled System

1. In case of a single installation [inch.]
2. In case of multiple unit installation [inch.]
3. Top view
4. Side view
5. Condensing unit
6. Service Space (front side)
7. Service Space (back side)
8. Space for installing water piping must be ample enough to remove the front panel.

9. Ventilation space (refer to Engineering Data Book for further details)
10. Secure spaces in the front, back, and top sides as same as the case of single installation.

11. Service space above the unit for refrigerant piping (refer to Engineering Data Book for further details)

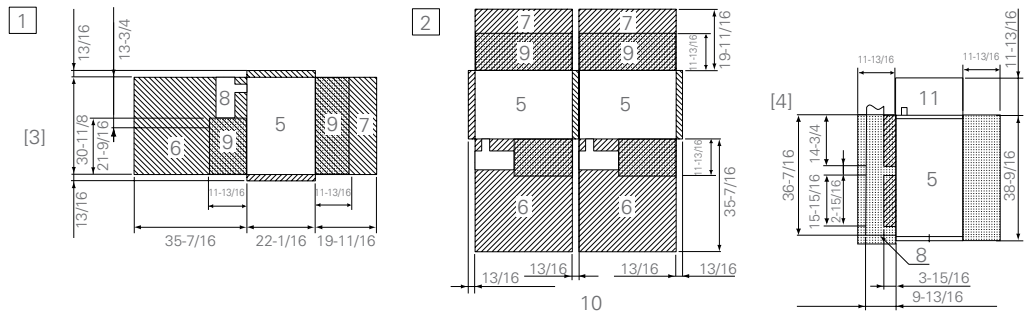

## VRV IV S-series

In case of series installation, some space between the units is needed for wiring with conduit and servicing.

1. Where there is an obstacle on the suction side:

- (a) No obstacle above
  - (1) Stand alone installation
    - Obstacle on the suction side only
    - Obstacle on both sides

2. Where there is an obstacle on the discharge side:

- (a) No obstacle above
  - (1) Stand alone installation

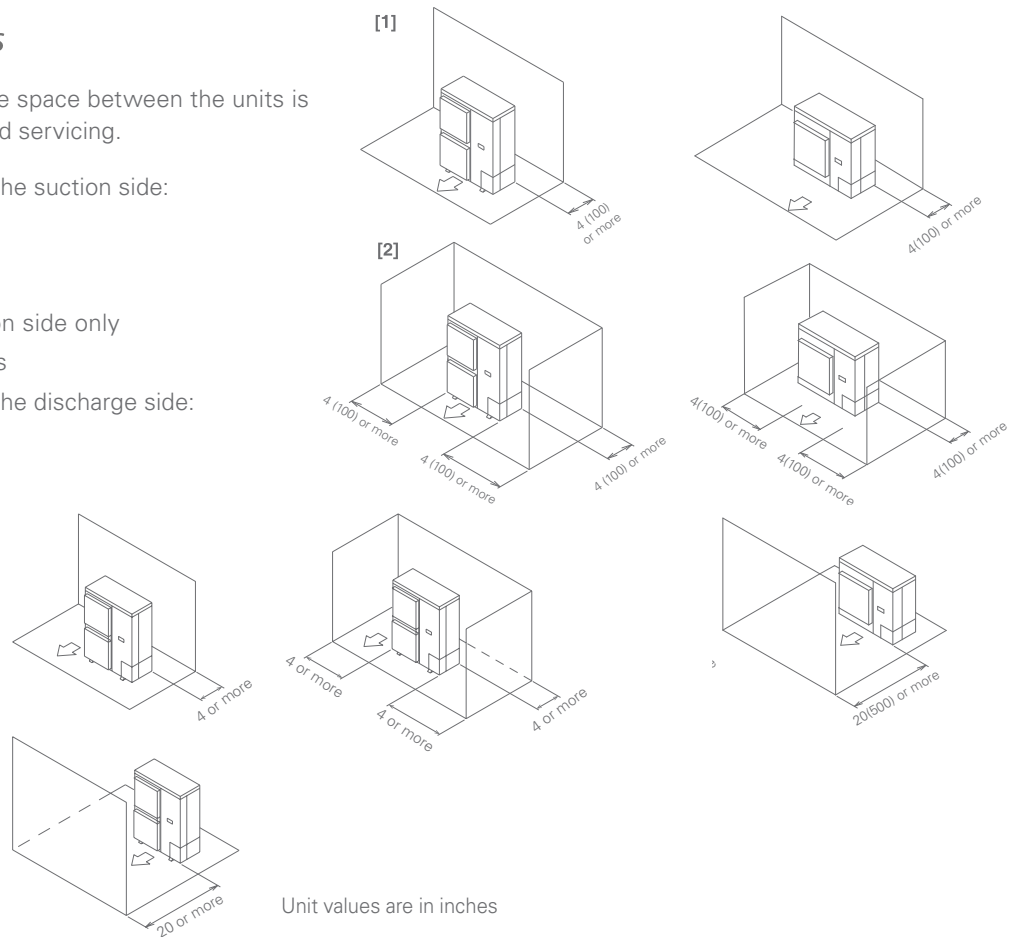

OUTDOOR UNITS

# VRV IV X, VRV IV & VRV AURORA™, VRV T-Series Water-Cooled & VRV IV-S Piping Length

The long piping length provides more design flexibility, which can match even large-sized buildings.

## Air-cooled system piping length

For connection of only VRV indoor units

	VRV IV X, VRV IV & VRV AURORA™	VRV IV-S
Max. actual piping length	541 ft.	230 ft. (3-Ton: 164 ft.)
Max. equivalent piping length	623 ft.	295 ft. (3-Ton: 213 ft.)
Max. total piping length	3281 ft. (AURORA: 1640 ft.)	984 ft. (3-Ton: 820 ft.)
Max. level difference between the outdoor units and the indoor units	295 ft.*	98 ft.
Max. level difference between the indoor units	100 ft.*	49 ft. (3-Ton: 33 ft.)
Max. distance from 1st refrigerant branch joint	295 ft.	130 ft.

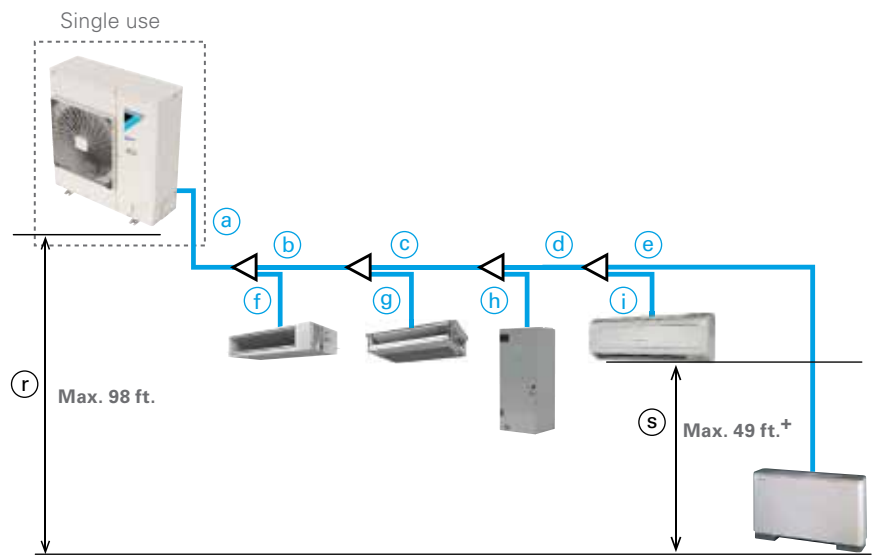

Piping for VRV IV X, VRV IV, VRV AURORA, and VRV IV-S

		ACTUAL PIPING LENGTH		EXAMPLE	EQUIVALENT PIPING LENGTH		
		VRV IV X / VRV IV / VRV AURORA	VRV IV-S		VRV IV X / VRV IV / VRV AURORA	VRV IV-S	VRV IV-S
Maximum allowable piping length	Refrigerant piping length	541 ft.	164 ft. 3-Ton 230 ft. 4-5 Ton	a+b+c+d+e	623 ft	213 ft	295 ft
	Total piping length	3281 ft. AURORA: 1640 ft.	820 ft. 984 ft.	a+b+c+d+e+f+g+h+i	—	—	—
	Between the first indoor unit branch and the farthest indoor unit	295 ft.*	98 ft. 98 ft.	b+c+d+e	—	—	—

		LEVEL DIFFERENCE		EXAMPLE	
		VRV IV X / VRV IV / VRV AURORA	VRV IV-S		
Maximum allowable level difference	Between the outdoor units (multiple use on the same circuit)	16 ft.	n/a n/a	—	
	Between the indoor units	98 ft.	33 49	s	
	Between the outdoor units and the indoor units	If the outdoor unit is above	295 ft.†	98 98	r
		If the outdoor unit is below	295 ft.	98 98	r

\* No special requirements up to 131 ft. The maximum actual piping length can be 295 ft., depending on conditions. Various conditions and requirements have to be met to allow utilization of 295 ft. piping length. Be sure to refer to the Engineering Data Book for details of these conditions and requirements.

† When level differences are 164 ft. or more, the diameter of the main liquid piping size must be increased and connection ratio must be 80% to 130%. If the outdoor unit is above the indoor unit, a dedicated setting on the outdoor unit is required. Refer to the Engineering Data Book and contact your local dealer for more information.



## Water-cooled system piping length

Water-Cooled systems provide considerable design flexibility with total piping lengths of up to 980 ft. and vertical separation of up to 164 ft.\* between condensing units and indoor units.

For connection of only VRV indoor units

Actual piping length between the VRV T-Series and indoor units: 540ft. (equivalent piping length: 623ft.)

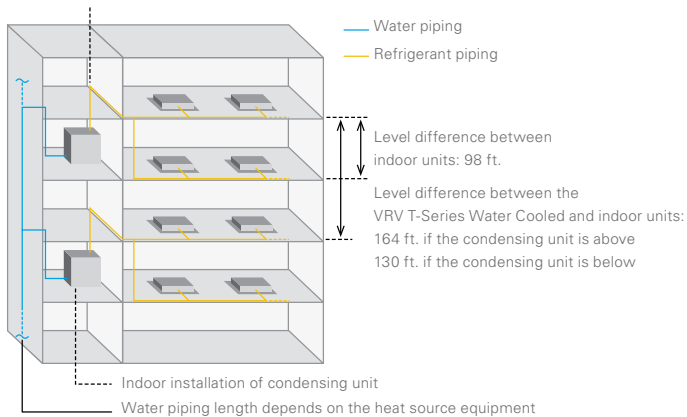

REFRIGERANT PIPING LIMITATIONS	LIMITATIONS
Linear piping between condensing unit and furthest located fan coil unit (equivalent), ft.	540 (623)
Total "one-way" piping in the complete piping network, ft.	980
Vertical (height) separation between the condensing unit and the fan coil units (if condensing unit is below)*, ft.	164 (130)
Vertical (height) separation between fan coil units, ft.	98
Linear piping between 1st REFNET and furthest located fan coil unit, ft.	130 (295)**

\* Conditions apply when the condenser is lower than indoor units. Refer to your local Daikin representative for further information.

\*\* Conditions/rules apply. Refer to Installation manual for further details.



# VRV Accessories

## Branch Selector Boxes

### Branch Selector Boxes for Heat Recovery Systems

Providing flexibility and minimizing mechanical and electrical installation costs, Daikin's branch selector boxes are ideal for spaces that require individual heating and cooling control.

- » Extended range of product offerings with 1, 4, 6, 8, 10 and 12 port options
- » No drain or condensate consideration required
- » Unlimited number of unused ports per box or system
- » Reduced electrical and mechanical installation costs
- » Ultimate flexibility – Choose multi-port or single-port styles to customize your design
- » Up to 72% reduction in footprint, as compared to previous generation models
- » Up to 17% lower sound levels compared to current VRV III models
- » Up to 65% reduction in weight, as compared to previous generation models

### Branch Selector Boxes Compatibility

Single-Port and Multi-Port Branch Selector Boxes BS-TVJ Series are compatible with VRV IV X, VRV IV and VRV T-Series Water-Cooled.



BSQ36TVJ, BSQ60TVJ,  
& BSQ96TVJ Single Port

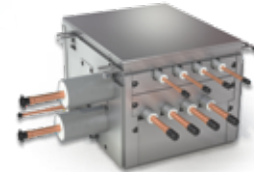

BS4Q54TVJ



BS6Q54TVJ



BS10Q54TVJ

OUTDOOR UNITS

Daikin's branch selector boxes are ideal for spaces that require individual heating and cooling control.

TECHNICAL DATA FOR MULTI-PORT BRANCH SELECTOR BOXES											
Model	BS4Q54TVJ		BS6Q54TVJ		BS8Q54TVJ		BS10Q54TVJ		BS12Q54TVJ		
Number of branches	4		6		8		10		12		
Maximum capacity index per branch					54						
Maximum total capacity index	144		216				290				
Maximum connectable indoor units per branch					5						
Connecting Pipes	IU	Liquid	in.		Ø1/4, Ø3/8						
		Gas	in.		Ø1/2, Ø5/8						
	IU	Liquid	in.		Ø3/8		Ø1/2		Ø5/8		
		Suction Gas	in.		Ø7/8		Ø1-1/8				
		HP/LP Gas	in.		Ø3/4		Ø1-1/8				
Electrical	Power Supply	ph/V/Hz		1/208-230/60							
	Maximum Overcurrent Protection, MOP	A		15							
	Minimum Circuit Amps, MCA	A		0.6		0.8		1		1.2	
Mass (Weight)	lbs.		49		68		73		101		
Dimensions (H x W x D)	in.		11-3/4 x 14-9/16 x 18-15/16		11-3/4 x 22-13/16 x 18-15/16		11-3/4 x 32-5/16 x 18-15/16				

**MULTI-PORT BRANCH SELECTOR BOX INSTALLATION SPACE**

MINIMUM CLEARANCE		BS4Q54TVJ	BS6Q54TVJ	BS8Q54TVJ	BS10Q54TVJ	BS12Q54TVJ
A	in.	20				
B	in.	11-3/4				

TECHNICAL DATA FOR SINGLE-PORT BRANCH SELECTOR BOXES							
Model	BSQ36TVJ		BSQ60TVJ		BSQ96TVJ		
Number of branches	1		1		1		
Maximum capacity index	36		60		96		
Maximum connectable indoor units	4		8		8		
Connecting Pipes	IU	Liquid	in.		Ø3/8		
		Gas	in.		Ø5/8		
	IU	Liquid	in.		Ø3/8		
		Suction Gas	in.		Ø5/8		
		HP/LP Gas	in.		Ø1/2		
Electrical	Power Supply	ph/V/Hz		1/208-230/60			
	Maximum Overcurrent Protection, MOP	A		15			
	Minimum Circuit Amps, MCA	A		0.1			
Mass (Weight)	lbs.		27		27		
Dimensions (H x W x D)	in.		8-1/8 x 15-1/4 x 12-13/16		33		

**SINGLE-PORT BRANCH SELECTOR BOX INSTALLATION SPACE**

MINIMUM CLEARANCE		BSQ36TVJ	BSQ60TVJ	BSQ96TVJ
A	in.	10	10	12
B	in.	10	10	12
C	in.	-	13-3/4	15-3/4
D	in.	12	13-3/4	15-3/4
E	in.	12	12	11-13/16

For additional technical information and all equipment installation and application limitations please refer to the specific Engineering Data Books.

OUTDOOR UNITS

# VRV Accessories

## REFNET Pipe Joints

### REFNET

REFNET joints distribute correct flow of refrigerant in every branch of the piping network.



REFNET Joint



REFNET Header

### VRV IV Heat Pump / VRV AURORA™ Heat Pump

OPTIONAL ACCESSORIES		RXYQ72T RXYQ96T RXLQ72T RXLQ96T	RXYQ120T RXYQ144T RXYQ168T RXLQ120	RXYQ192T RXYQ216T RXYQ240T RXYQ264T RXYQ288T	RXYQ312T RXYQ336T RXLQ144T RXLQ192T RXLQ240T	RXYQ360T RXYQ384T RXYQ408T
Distributed piping	REFNET Header	KHRP26M22H (max. 4 branch) KHRP26M33H (max. 8 branch)	KHRP26M22H (max. 4 branch) KHRP26M33H (max. 8 branch) KHRP26M72H (max. 8 branch)	KHRP26M22H (max. 4 branch) KHRP26M33H (max. 8 branch) KHRP26M72H (max. 8 branch) KHRP26M73H (max. 8 branch)		
	REFNET Joint	KHRP26A22T, KHRP26A33T	KHRP26A22T, KHRP26A33T, KHRP26M72TU	KHRP26A22T, KHRP26A33T, KHRP26M72TU, KHRP26M73TU		
Outdoor unit multi connection piping kit		—		BHFP22P100U	BHFP22P151U	

### VRV IV X Heat Recovery / VRV IV Heat Recovery / VRV AURORA™ Heat Recovery

OPTIONAL ACCESSORIES		REYQ72T REYQ96T	RELO72T RELO96T	REYQ120T REYQ144T REYQ168T	RELO120T	REYQ192T REYQ216T REYQ240T REYQ264T REYQ288T REYQ312T REYQ336T	RELO144T RELO192T RELO240T	REYQ360T REYQ384T REYQ408T REYQ432T REYQ456T
		REYQ72X REYQ96X		REYQ120X REYQ144X REYQ168X		REYQ192X REYQ216X REYQ240X REYQ264X REYQ288X REYQ312X REYQ336X		REYQ360X REYQ384X REYQ408X REYQ432X REYQ456X
Distributed piping	REFNET header	KHRP25M33H9 (max. 8 branch)		KHRP25M33H9 (max. 8 branch) KHRP25M72H9 (max. 8 branch)	KHRP25M33H9 (max. 8 branch) KHRP25M72H9 (max. 8 branch) KHRP25M73H9 (max. 8 branch)			
	REFNET joint	KHRP25A22T9 KHRP25A33T9		KHRP25A22T9 KHRP25A33T9 KHRP25M72TU9	KHRP25A22T9 KHRP25A33T9 KHRP25M72TU9 KHRP25M73TU9			
Outdoor unit multi connection piping kit		—		—		BHFP26P100U	BHFP26P151U	

OUTDOOR UNITS

# VRV Accessories

## REFNET Pipe Joints & Hail Guard Kit for VRV IV

### VRV T-Series Water-Cooled Heat Pump / Heat Recovery and VRV-IV-S

UNIT MODEL NUMBER		VRV T-SERIES WATER-COOLED				VRV-IV-S	
		RWEQ96TATJU RWEQ96TAYDU	RWEQ120TATJU RWEQ120TAYDU	RWEQ144TATJU RWEQ144TAYDU	RWEQ192,216,240, 264,288TATJU RWEQ192,216,240, 264,288TAYDU	RWEQ312,336,360TATJU RWEQ312,336,360TAYDU	RXTQ36TAVJ9 RXTQ48TAVJU RXTQ60TAVJU
REFNET Header	Heat Pump	KHRP26M22HR (Max 4 branch) KHRP26M33H9 (Max 8 branch)	KHRP26M22H9 (Max 4 branch), KHRP26M33H9 (Max 8 branch) KHRP26M72H9 (Max 8 branch)	KHRP26M22H9 (Max 4 branch), KHRP26M33H9 (Max 8 branch) KHRP26M72H9 (Max 8 branch), KHRP26M73HU9 (Max 8 branch)	KHRP26M22H9 (Max 4 branch), KHRP26M33H9 (Max 8 branch) KHRP26M72H9 (Max 8 branch), KHRP26M73HU9 (Max 8 branch)	KHRP26M22H9 (Max. 4 branch) KHRP26M33H9 (Max. 8 branch)	
	Heat Recovery	KHRP26M33H9 (Max 8 branch)	KHRP25M33H9 (Max 8 branch) KHRP25M72H9 (Max 8 branch)	KHRP25M33H9 (Max 8 branch) KHRP25M72H9 (Max 8 branch)	KHRP25M33H9 (Max 8 branch), KHRP25M72H9 (Max 8 branch) KHRP25M73HU9 (Max 8 branch)	---	
REFNET Joint	Heat Pump	KHRP26A22T9, KHRP26A33T9	KHRP26A22T9, KHRP26A33T9, KHRP26M72TU9	KHRP26A22T9, KHRP26A33T9, KHRP26A72UT9, KHRP26M73TU9	KHRP26A22T9, KHRP26A33T9, KHRP26A72UT9, KHRP26M73TU9	KHRP26A22T9	
	Heat Recovery	KHRP25A22T9, KHRP25A33T9	KHRP25A22T9, KHRP25A33T9, KHRP25M72TU9	KHRP25A22T9, KHRP25A33T9, KHRP25A72TU9, KHRP25M73TU9	KHRP25A22T9, KHRP25A33T9, KHRP25A72TU9, KHRP25M73TU9	---	
Outdoor Unit Multi Piping Connection Kit	Heat Pump	---	---	BHFP22T84U	BHFP22T126U	---	
	Heat Recovery	---	---	BHFP26T84U	BHFP26T126U	---	

### Hail Guard Kit for VRV IV and VRV AURORA™

The optional hail guard kit for VRV IV and VRV AURORA enables optimal airflow for efficient heat transfer while providing condenser coil protection from hail damage in severe climates. Each hail guard kit, that is field installed, consists of 4 panels (Right, Left, Front and Back).

KIT PART NUMBER	QUANTITY OF KITS PER ODU MODELS					PANEL DIMENSIONS (H X W X D)			
	R_YQ72T	R_YQ96-168T R_LQ72-120T R_YQ72-168X	R_YQ192T	R_YQ216-336T R_LQ144-240T R_YQ192-336X	R_YQ360-456T R_YQ360-456X	Right Panel	Left Panel	Front Panel	Front Panel
VRV4HGS-K1	1		1					45 <sup>7</sup> / <sub>8</sub> " x 13 <sup>1</sup> / <sub>4</sub> " x 4"	45 <sup>7</sup> / <sub>8</sub> " x 32 <sup>5</sup> / <sub>8</sub> " x 4"
VRV4HGL-K1		1	1	2	3	45 <sup>7</sup> / <sub>8</sub> " x 26" x 4"	45 <sup>7</sup> / <sub>8</sub> " x 12 <sup>7</sup> / <sub>8</sub> " x 4"	45 <sup>7</sup> / <sub>8</sub> " x 24" x 4"	45 <sup>7</sup> / <sub>8</sub> " x 44 <sup>3</sup> / <sub>4</sub> " x 4"

Service space requirements for the front, back and sides of the condensing unit must be at least 4" greater than the service space requirements provided in the condensing unit installation manual and engineering guide.

If the condensing units in multiple unit installations are installed between 0.75" and 3" maximum between units, the side hail guard panels between modules may not be required. For further separation between the modules, full kits for each module may be required.

### Snow/Wind Hood Kits

The optional Snow/Wind Hood Kits mount to VRV IV, IV X, and VRV AURORA series units over the heat exchanger coil to protect from snow build-up and wind in cold climates. The Hoods install easily to condensing units using existing screw taps with no modification required. Different kits can be ordered for different job requirements.

KIT PART NUMBER	CHASSIS SIZE	KIT INCLUSION	
VRV-SHS-FR	Small Chassis	Front Hood	Rear Hood
VRV-SHL-FR	Large Chassis	Front Hood	Rear Hood
VRV-SH-RL	Both Chassis	Right Hood	Left Hood
VRV-SHS-T	Small Chassis	Top Hood	
VRV-SHL-T	Large Chassis	Top Hood	

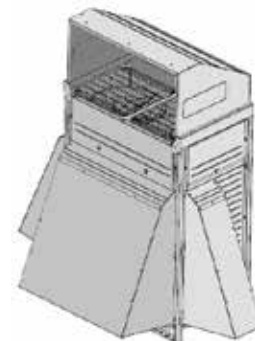

OUTDOOR UNITS

# Air Handling Kit (AHU) Integration Kit

## Designed for High Efficiency

The Daikin Air Handling Unit Integration Kit enables a non-VRV Air Handling Unit to be fully integrated into a Daikin VRV system, allowing the benefits of inverter technology to extend to custom terminal units and air handling equipment.

Designed for high system efficiency, the Air Handling Unit Integration Kit offers a seamless integration and optimized design flexibility for Air Handling Units while keeping total installation and commissioning time to a minimum.

A kit consists of one Control Box and one EEV Box. Two different control methods can be used for an evaporator coil of up to 16 tons.

## Features and Benefits

- » Enables non-VRV Air Handling Units to be seamlessly integrated into a Daikin VRV system
- » Integrates to VRV Heat Pump and Heat Recovery systems\*
- » Daikin DIII-NET communication compatible — can be used with both Daikin *iTM* and NAV controller
- » Separate Control Box and EEV Box accommodates flexible installation
- » Available with two control methods:
  - EKEQMCAV3-US (Z-Control)
  - Standard VRV indoor unit room temperature control
  - EKEQFCBAV3-US (W-Control)
  - Field supplied temperature sensor
  - Field supplied DDC controller with 0-10V capability)

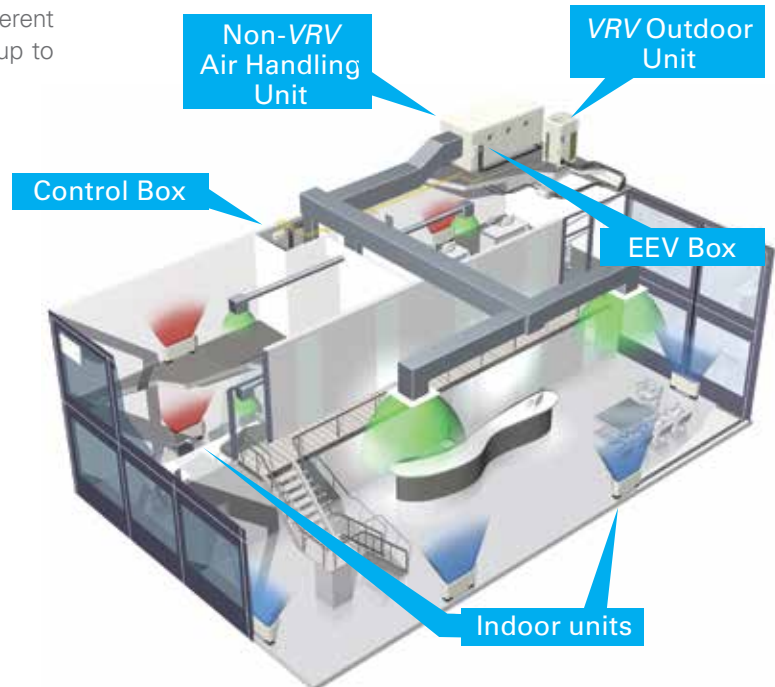
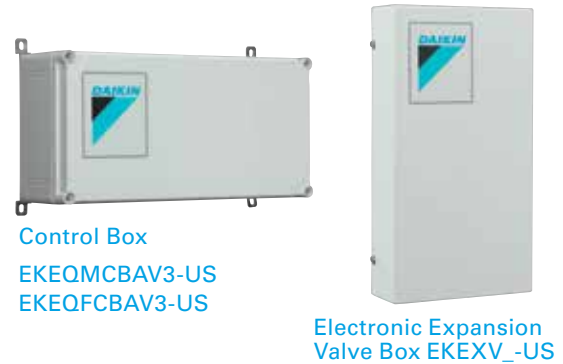

\* Important! For any VRV systems that utilize the AHU integration kits to perform as intended, the DX coil(s) in the non-VRV AHU unit(s) must meet the range of criteria set forth in the AHU Integration Kit Selection Guide and all associated piping and combination rules (refer to IOD-7041A and IOD-7042A), and should be installed in accordance to the installation manual provided with the EKEQ control boxes.

OUTDOOR UNITS



ELECTRONIC EXPANSION VALVE BOX SPECIFICATIONS		EKEXV50-US	EKEXV63-US	EKEXV80-US	EKEXV100-US	EKEXV125-US	EKEXV140-US	EKEXV200-US	EKEXV250-US	EKEXV400-US	EKEXV500-US	
Nominal Capacity	BTU/h	18,000	24,000	30,000	36,000	48,000	60,000	72,000	96,000	144,000	192,000	
AHU Heat Exchanger Cooling Capacity Range	BTU/h	17,000-21,000	21,500-26,500	27,000-34,500	34,000-42,000	42,500-52,500	53,000-60,000	60,500-84,000	84,500-105,000	120,000-169,000	170,000-210,000	
AHU Heat Exchanger Heating Capacity Range	BTU/h	19,000-24,000	24,200-30,000	30,500-38,000	38,500-47,000	47,500-59,000	59,500-67,500	68,000-94,500	95,000-118,500	136,000-187,500	188,000-236,500	
AHU Heat Exchanger Refrigerant Volume Range	in <sup>3</sup>	46-100	101-126	127-161	162-201	202-251	252-281	282-402	403-503	564-804	806-1006	
Power Supply	V/ph/Hz	208-230/1/60										
Weight	lbs.	6.4										
Height	in.	15-3/4										
Width	in.	8-1/2										
Depth	in.	3-1/16										
Pipe Connections	in.	1/2 x 1/4	3/8 x 5/8				3/4 x 3/8		7/8 x 3/8	1-1/8 x 1/2	1-1/8 x 5/8	

\* Important! For any VRV systems that utilize the AHU integration kits to perform as intended, the DX coil(s) in the non-VRV AHU unit(s) must meet the range of criteria set forth in the AHU Integration Kit Selection Guide and all associated piping and combination rules (refer to IOD-7041A and IOD-7042A), and should be installed in accordance to the installation manual provided with the EKEQ control boxes.



### Features and Benefits

- » Designed for both indoor and outdoor installation
- » Equipped with refrigerant filters on both sides of the expansion valve
- » Can be mounted up to 16 ft (5m) away from the air handling unit
- » Simplified installation with inlet and outlet brazed connections
- » Wide range that covers from 1.5 ton to 16 ton
- » Same EEVs as used in standard VRV Indoor product to deliver precise refrigerant control

# Control Box

## EKE\_CBAV3-US

### EKEQMCAV3 - US

For use with both Daikin VRV indoor units and custom air handling units

- » Allows for discharge air control
- » Seamless integration of non-VRV air handling units with VRV IV HP and HR systems
- » Enables control of the AHU as a VRV Indoor unit when integrated with a Daikin remote control
- » Connect other VRV indoor units along with the AHU to the condensing units
- » Provides remote ON/OFF option when integrated with optional KRP4A71 board
- » Designed for both indoor and outdoor installations

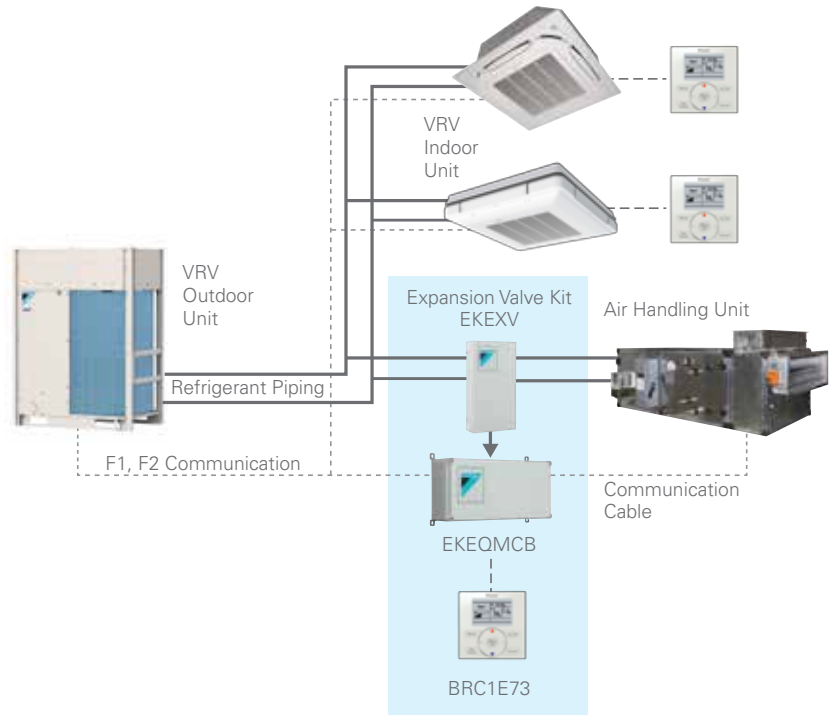

### EKEQFCBAV3 - US

For use with custom air handling units only

- » Seamlessly integrate non-VRV air handling units with VRV IV HP
- » Best suited for applications where 1 AHU is connected to 1 VRV system only
- » Connect up to 3 integration kits per VRV system to serve a large capacity AHU
- » Unified cooling and heating mode programming
- » Enables control of AHU unit using field temperature sensor and 0-10V field supplied DDC controller
- » Allows for discharge air temperature control

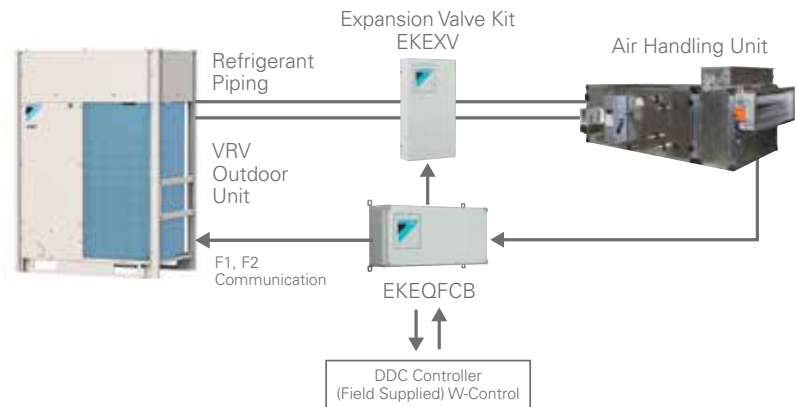

OUTDOOR UNITS



# Control Box EKE\_CBAV3-US (cont.)



CONTROL BOX SPECIFICATIONS		EKEQMCBAV3-US (Z-Control)	EKEQFCBAV3-US (W-Control)
Entering Air Temperature Limits	Cooling °F	57 WB - 77 WB	95 DB/77 WB
	Heating °F	50 DB - 80 DB	Min. of 50 DB
Power Supply	V/ph/Hz	208-230/1/60	
Weight	lbs.	8	8.6
Height	in.	5-13/64	
Width	in.	15-3/4	
Depth	in.	9-3/8	
Connection Ratio		50 - 110%	90 - 110%
Max Piping Distance	EKEXV to AHU	16 ft.	16ft.
	ODU to AHU	Standard VRV outdoor unit piping limitations based on model selection apply	
Max number of IDU/system			
VRV IDU + AHU		64	Not available
AHU Only		32	1

COMPATIBILITY MATRIX	EKEQMCBAV3-US (Z-Control)	EKEQFCBAV3-US (W-Control)
VRV IV HP (RXVQ_TATJU/TAYDU)	■	■
VRV IV HR (REYQ_TATJU/TAYDU)	■	Not available
VRV T-Series Water-Cooled (RWEQ_TATJU/TAYDU)	■	■
VRV III PC (REYQ_PCTJ/PCYD)	■	Not available
VRV IV S (RXTQ_TAVJU(9))	Not available	Not available

■ Heat pump configuration only

OUTDOOR UNITS

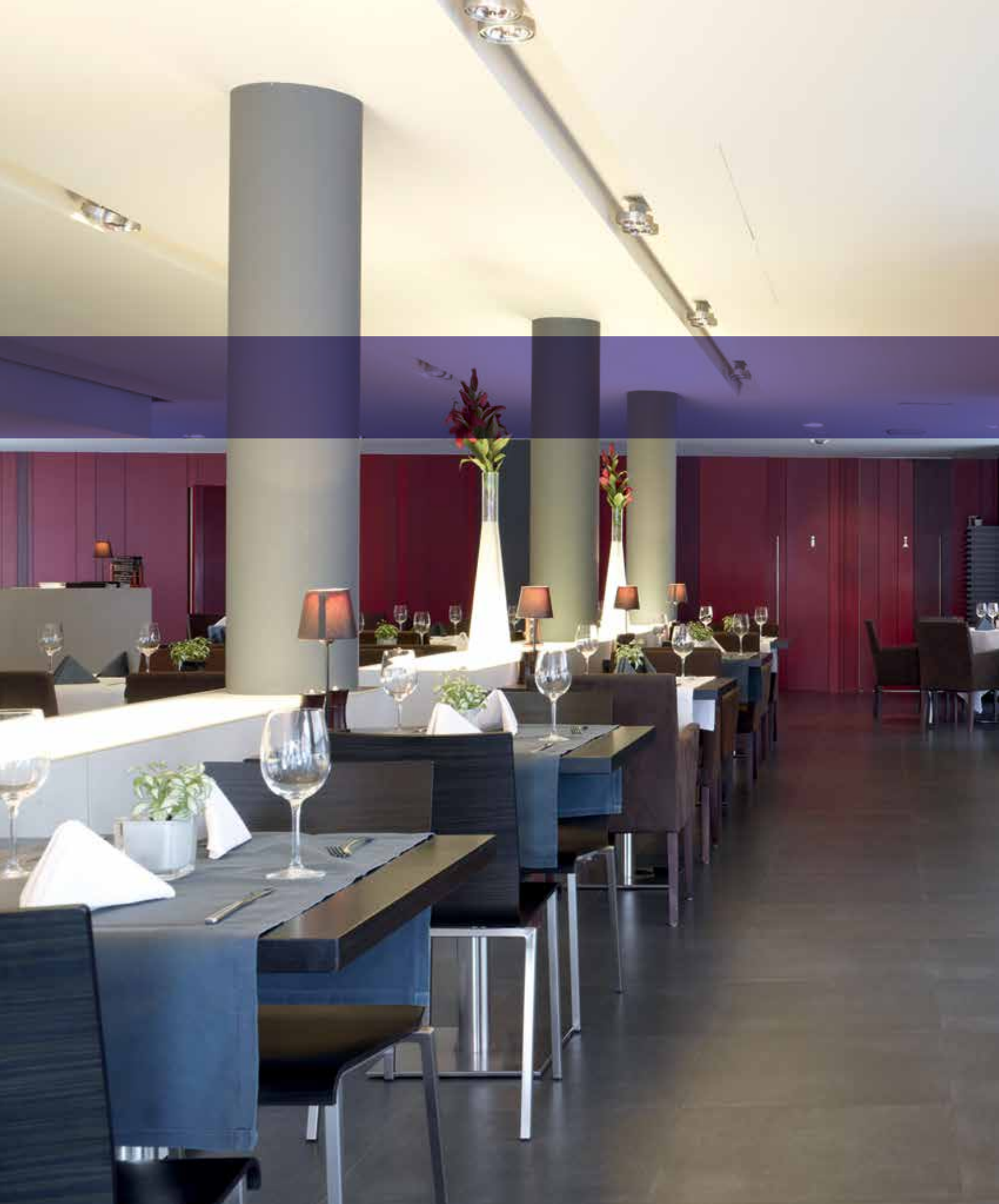



# Ventilation

# Air Treatment Systems

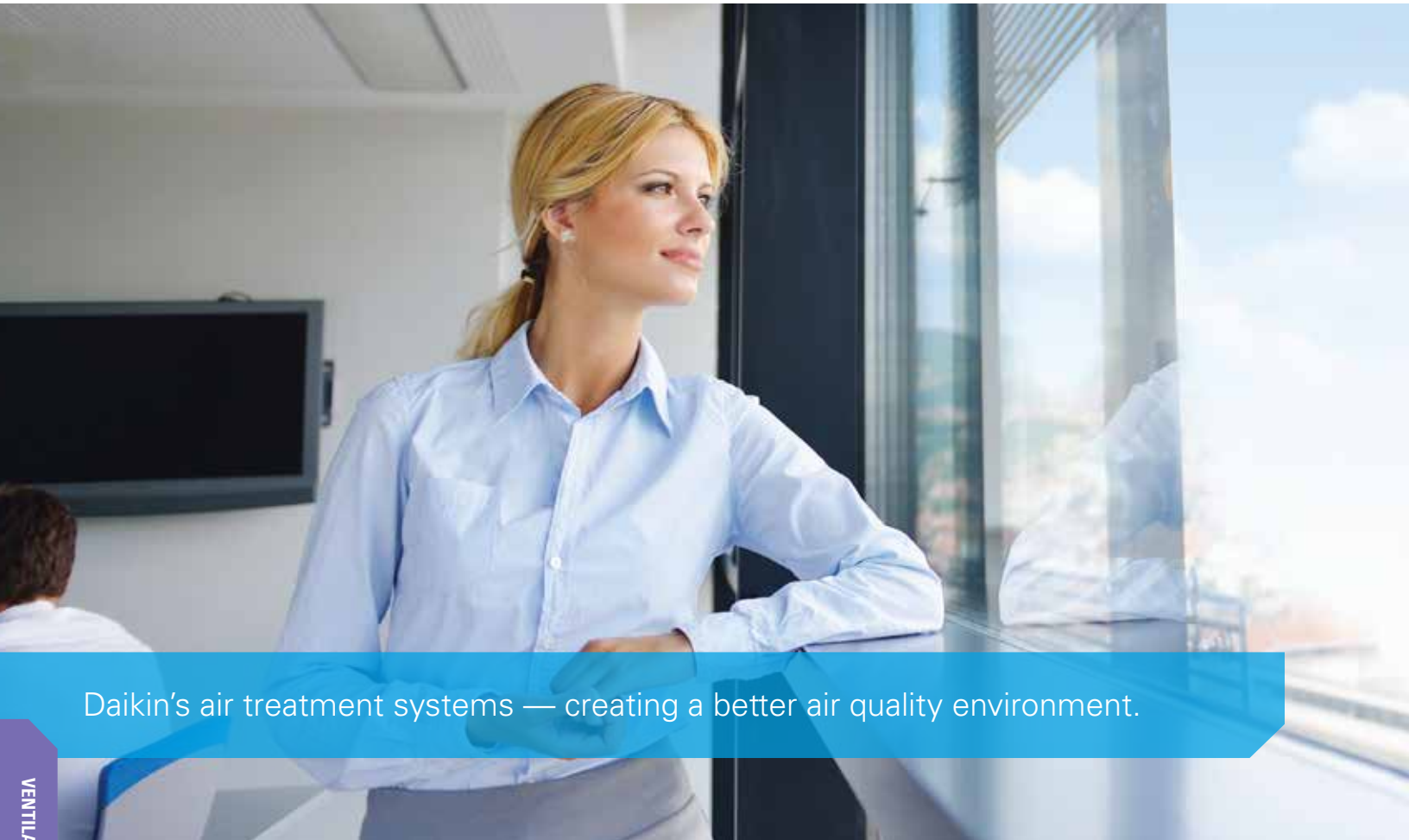

Daikin's air treatment systems — creating a better air quality environment.

VENTILATION

Daikin's Outside Air Processing Unit can be integrated with a *VRV* system to provide outside air treatment and air conditioning in a single system to meet code requirements. It adjusts the temperature of air from outdoors using a fixed discharge temperature control reducing air conditioning load.

In addition to Outside Air Processing Units, we also offer Energy Heat Recovery units. The Energy Heat Recovery VAM-GVJU series units combines compactness, energy conservation, and extensive operation range of outdoor temperatures. This series provides higher enthalpy efficiency, due to the greatly enhanced performance of the thin heat exchanging element. Furthermore, improved external static pressure offers more flexibility for installation.



	OUTSIDE AIR PROCESSING UNIT, FXMQ_MFVJU	ENERGY RECOVERY VENTILATOR, VAM-GVJU
--	-----------------------------------------	--------------------------------------



VRV Refrigerant Piping	Connectable	Not connectable
VRV Control Wiring	Connectable	
High Efficiency Filter (MERV 8 and MERV 13)	Option	Not available
Ventilation System	Air supply	Air supply and Air exhaust
Power Supply	V/ph/Hz	208-230/1/60
Airflow Rate	CFM	300/300/170 470/470/390 600/600/500 1200/1200/930

## FXMQ\_MFVJU

# 100% Outside Air Processing Unit



Outside Air Integration Possible

Filter Included

## Concealed, Powerful, Compact, Quiet, Fresh Air Quality

This unit provides a zoned, decentralized approach to conditioning outside air. This helps to reduce ductwork and installation time while increasing efficiency and flexibility. Both outside air treatment and space conditioning can be provided from one compact, flexible and efficient VRV system. VRV indoor units and outdoor air processing unit can be connected to the same refrigerant line, enabling enhanced design flexibility.

### Features and Benefits

- » Available in three capacities, nominal 48, 72 and 96 MBH
- » The nominal airflow rates are 635, 988, and 1,236 CFM respectively
- » External static pressure capabilities of up to 1.03" W.G. allows for flexibility with duct work and filtration choices
- » The indoor unit is controlled to a set cooling and heating discharge air temperature allowing the flexibility to integrate with a standard Daikin indoor unit or duct directly to the space
- » A low profile design of only 18.5" high reduces the required installation space and can eliminate mechanical rooms or additional structural supports associated with traditional OA systems
- » Indoor Air Quality options include MERV 8 and 13 filters and filter boxes
- » Can be connected to all North American Daikin VRV systems
- » Connects directly and seamlessly into the Daikin local and centralized controllers

### Operational Characteristics

When the suction air temperature is between 66°F and 109°F, the Outside Air Processing Unit operates in cooling, and when between 23°F and 59°F, it operates in heating. The OA processing unit will work in energy saving fan only between 59°F and 66°F.



Layout example

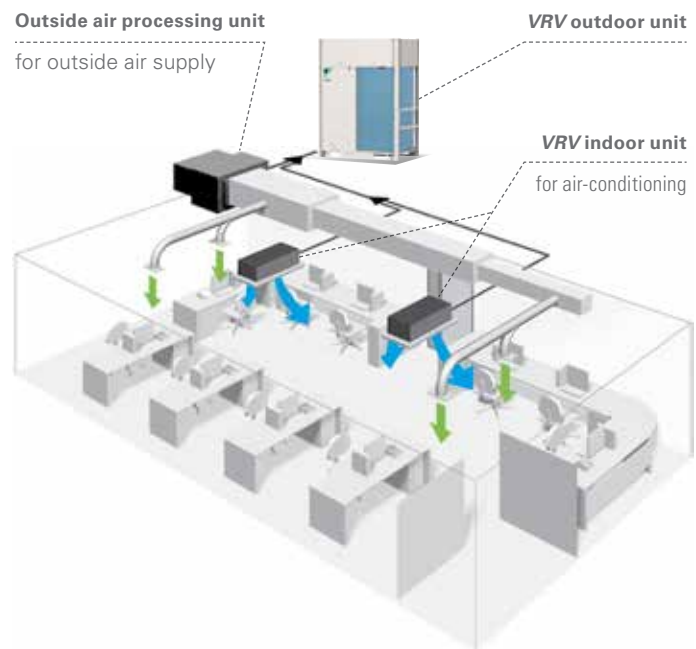

### Applications

- » Hotel/conference centers
- » Schools
- » Retail shopping centers
- » Large open-plan offices
- » Churches

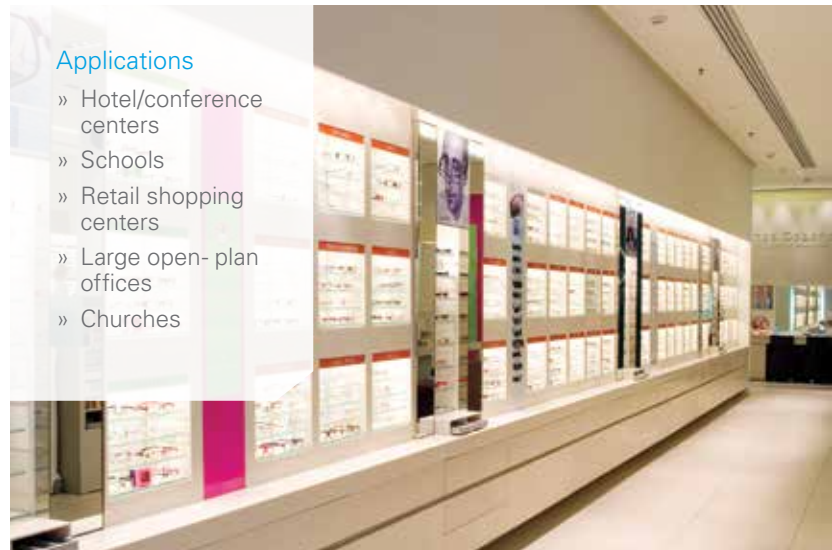

FXMQ_MFVJU SPECIFICATIONS			4 TON	6 TON	8 TON
Model Name			FXMQ48MFVJU	FXMQ72MFVJU	FXMQ96MFVJU
Power Supply	V/ph/Hz		208-230/1/60		
Rated Cooling Capacity	BTU/h		48,000	72,000	96,000
Rated Heating Capacity	BTU/h		30,000	47,000	59,000
Airflow Rate	CFM		635	988	1,236
Weight	lbs.		190	271	
Height	in.		18-1/2		
Width	in.		29-1/4	54-3/8	
Depth	in.		43-5/16		
Sound Pressure	dB(A)		47		
External Static Pressure	in. Wg		0.88	0.96	1.03
Pipe Connections	Gas	in.	5/8	3/4	7/8
	Liquid	in.	3/8		
Protection Devices			Fuse		
			Fan Motor Thermal Protector		
External Finish			Galvanized Steel Plate		
Operating Range - Cooling	°F		66 DB/59 WB - 109 DB/90 WB		
Operating Range - Heating	°F		23 DB to 59 DB		
Discharge Air Temp. - Cooling	°F		55-77		
Discharge Air Temp. - Heating	°F		64-86		

**Nominal Conditions:**

**Cooling Mode**

Discharge Set Temperature: 64 °F DB  
 Outdoor: 91 °F DB, 82 °F WB (68% RH)  
 Pipe Length: 25 ft.  
 Level Difference: 0 ft.

**Heating Mode**

Discharge Set Temperature: 77 °F DB  
 Outdoor: 32 °F DB, 27 °F WB (50% RH)  
 Pipe Length: 25 ft.  
 Level Difference: 0 ft.

Note: Specifications are subject to change without notice.

FXMQ_MFVJU ACCESSORIES			
Model Name	FXMQ48MFVJU	FXMQ72MFVJU	FXMQ96MFVJU
Navigation™ Remote Controller		BRC1E73	
Wireless Remote Controller		BRC4C82	
Remote Sensor Kit		KRCS01-1B	
Wiring Adaptor PCB (interface with aux/primary heater, humidifier, OA damper/fan)		KRP1C74	
Group Control Adaptor PCB (connects to external BMS)		KRP4A71	
High Efficiency Filter Kit (MERV 13)	DACA-MQ48F131K		DACA-MQ96F131K
High Efficiency Filter Kit (MERV 8)	DACA-MQ48F-8-1K		DACA-MQ96F-8-1K

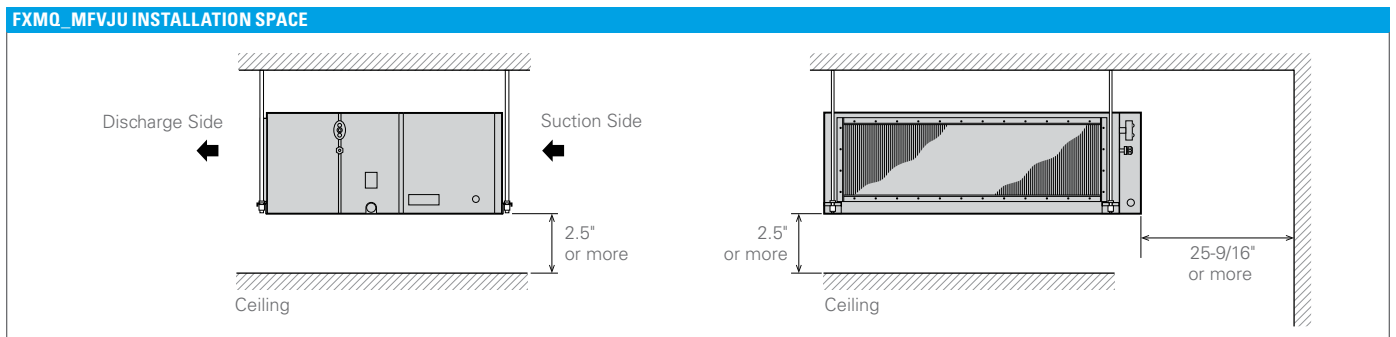

VENTILATION

# VAM-GVJU

## Energy Recovery Ventilator

 Outside Air  
Integration Possible

### Energy Efficient, Logical, Compact

This Energy Recovery Ventilator is designed to maintain good indoor air quality by providing sufficient levels of outside air and recover waste heat from exhaust air leaving the conditioned zone. It is also fully compatible with Daikin's DIII-NET communications.

### Features and Benefits

- » Provides energy saving heat recovery ventilation via a heat exchanger with temperature and enthalpy recovery efficiency
- » 0-4% return cross leakage rating
- » Superior performance with a high efficiency fan and the capability for use in a wide range of climates
- » (5 to 122° FDB and 80% RH or less)
- » Unique functions such as independent operation, third party equipment interlocking and automatic night purge to reduce cooling loads and increase energy savings
- » Interlocked simultaneous operation with VRV indoor units
- » Pre-cooling/heating control function to delay the start of ventilation during air conditioner start-up for higher energy savings
- » Supply and exhaust fresh-up operation modes to help control pressure within a space
- » Filter sign and display reset notifies when filter changes are required
- » Temperature recovery efficiency up to 74%
- » Enthalpy recovery efficiency up to 65%
- » ESP as high as 0.76" W.G.
- » Sound levels as low as 25.5 dB(A) for sound sensitive installation locations

Heat exchanger with high temperature and enthalpy efficiency

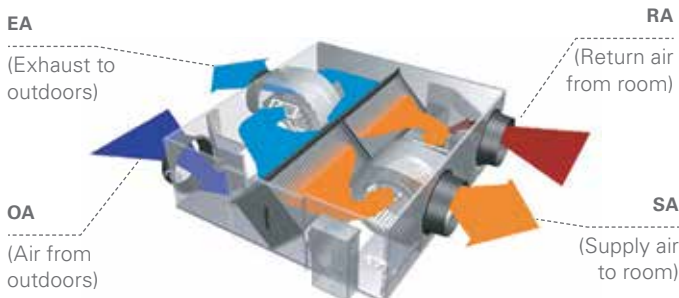

Layout example

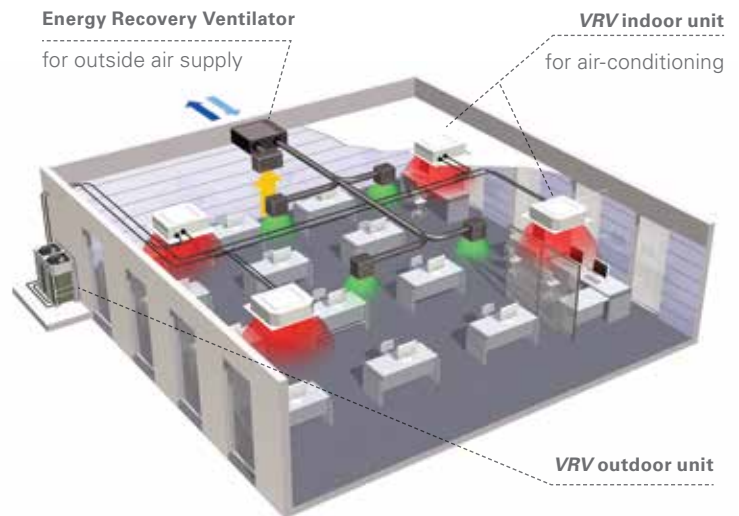

### Applications

- » Hotel/conference centers
- » Schools
- » Retail shopping centers
- » Large open-plan offices
- » Churches

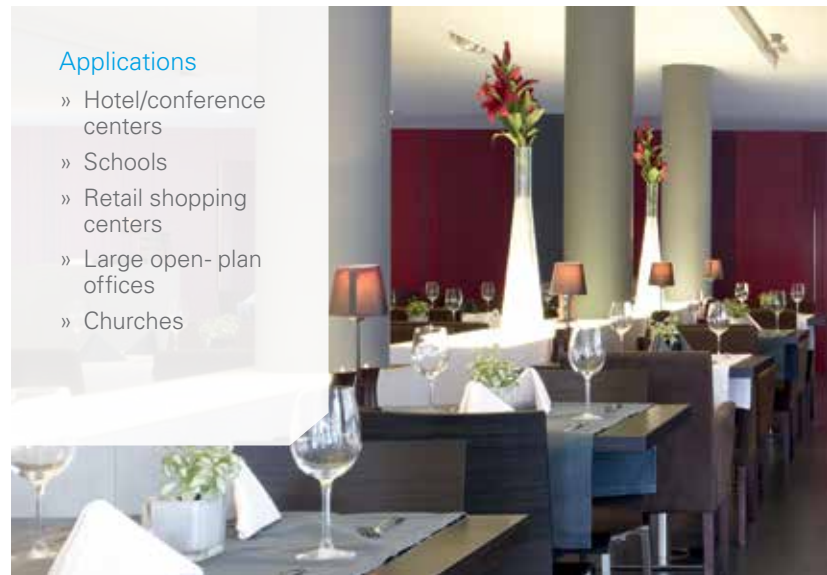



VAM SPECIFICATIONS							
Model Name		Airflow		VAM300GVJU	VAM470GVJU	VAM600GVJU	VAM1200GVJU
Temperature Recovery Efficiency Percentage	Cooling	100	%	65	68		72
		75	%	70	72		74
	Heating	100	%	65	66		70
		75	%		69		73
Enthalpy Recovery Efficiency Percentage	Cooling	100	%	40	45		49
		75	%	48	50		52
	Heating	100	%	57	59		60
		75	%	63	65		63
Power Supply				V/ph/Hz			208-230/1/60
Airflow Rate (H/M/L)	Heat Exchange Mode	CFM		300/300/170	470/470/390	600/600/500	1,200/1,200/930
	Bypass Mode			300/300/170	470/470/390	600/600/500	1,200/1,200/930
Weight			lbs.	71	121	148	346
Height			in.	12-1/16	15-1/4	15-1/4	30-7/8
Width			in.	34-5/8	43-11/16		63-3/4
Depth			in.	31-1/2	32-3/4	47-13/16	
Sound Pressure (H/M/L)			dB(A)	37/33.5/25.5	42/38.5/35	42.5/39/36	44.5/41.5/38.5
External Static Pressure (H/M/L)			in. Wg	0.64/0.26/0.16	0.73/0.39/0.33	0.76/0.34/0.32	0.56/0.24/0.16
External Finish							Galvanized Steel Plate
Insulation Material							Self-Extinguishing Urethane Foam
Connection Duct Diameter			in.	8	10		14
Ambient Conditions			A				5°F – 122°F DB 80% RH or less

### VAM-GVJU INSTALLATION EXAMPLE

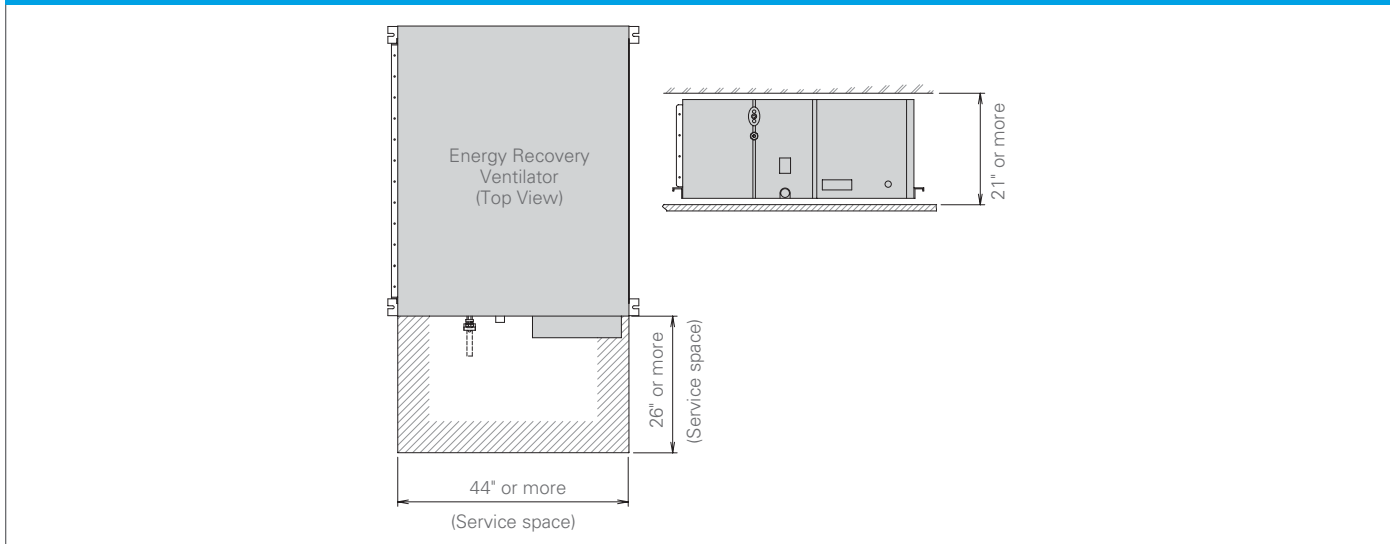

# DVS Dedicated Outside Air System Air Handling Unit Outdoor-Mounted AHU

## Seamless Integration with VRV Systems

Daikin DVS Dedicated Outside Air System (DVS - DOAS AHU) is designed for seamless integration with VRV air-cooled heat recovery outdoor units and controls to provide conditioning of 100% outside ventilation air.

Models, with nominal 1,000, 2,000 and 3,000 CFM air flow rates, can be configured with pre-treatment, cooling, reheat and heating components to be applied to a wide variety of commercial applications desiring the advanced features that VRV offers.

### Features and Benefits

- » Designed to condition outside air so the comfort system can operate to meet the internal loads while the DVS DOAS AHU's for VRV Systems conditions the outside air and can also deliver neutral air to the space
- » Energy Recovery Wheel section can reduce the mechanical cooling capacity of the system compared to a system without the ERW section
- » Auxiliary heat available in modulating gas heat, SCR controlled electric heat or hot water
- » DVS DOAS AHU's can be integrated into the same intelligent Touch Manager™ (iTM) as the comfort cooling and heating VRV system
- » Piping connections between the DVS DOAS AHU's and the VRV outdoor units can be made outside
- » Air flow ranges from 670 to 4,000 cfm allow for flexibility in design



VENTILATION

DVS DEDICATED OUTSIDE AIR					
Model Name		DVSV05 with ERW	DVSV10 with ERW	DVSV12 with ERW	
Nominal Air Flow	CFM	1,000	2,000	3,000	
Nominal (Minimum-Maximum)		(670 - 1,350)	(1,600 - 2,650)	(2,000 - 4,000)	
Nominal Cooling Capacity	BTU/h	41,000	73,000	127,000	
Dimensions <sup>1</sup> (L x W x H)	in.	103 x 71 x 41	133 x 75 x 57		
Weight <sup>1</sup>	lbs.	1,287	2,266	2,371	
Electrical		3-Phase 208V, 3-phase 230V or 3-Phase 460V			
Refrigerant	Type	R410A			
Auxiliary heater	Gas furnace	MBH	80 / 120 / 160	200 / 300 / 400	200 / 300 / 400
	Electric heater (kW)	kW	6 / 12 / 18 / 30	30 / 6 / 54	36 / 54 / 72

<sup>1</sup> Weights, dimensions and performance of units are subject to change and will vary based on the components and options that are applied for specific applications. Nominal conditions: Entering air temperature 95°F DBT / 78°F WBT; 55°F leaving air temperature DX coil; 70°F discharge air temperature.

# Controls



# VRV Controls Solution

## What are your choices?

### Zone Controllers



Navigation™ Remote Controller (BRC1E73)

Simplified Remote Controller (BRC2A71)

Wireless Remote Controller

DKN Cloud Wi-Fi Adaptor

### Multi-Zone Controllers



iTM™ (DCM601A71)

iTC™ (DCS601C71)

Central Remote Controller (DCS302C71)

Unified On/Off Controller (DCS301C71)

Schedule Timer (DST301BA61)

### Interface Solutions

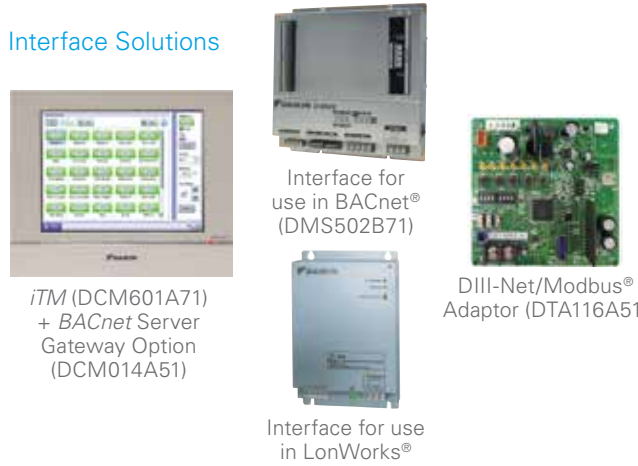

iTM (DCM601A71) + BACnet Server Gateway Option (DCM014A51)

Interface for use in BACnet® (DMS502B71)

DIII-Net/Modbus® Adaptor (DTA116A51)

Interface for use in LonWorks® (DMS504C71)

### External Equipment Control



iTM (DCM601A71) + BACnet Client Option (DCM009A51)

WAGO® I/O

Daikin WAGO® BACnet®/IP Controller (750-831)

### Adaptors

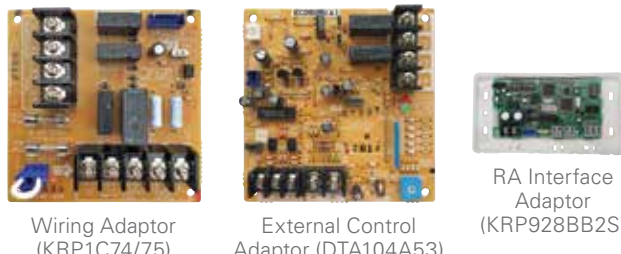

Wiring Adaptor (KRP1C74/75)

External Control Adaptor (DTA104A53)

RA Interface Adaptor (KRP928BB2S)

CONTROLS

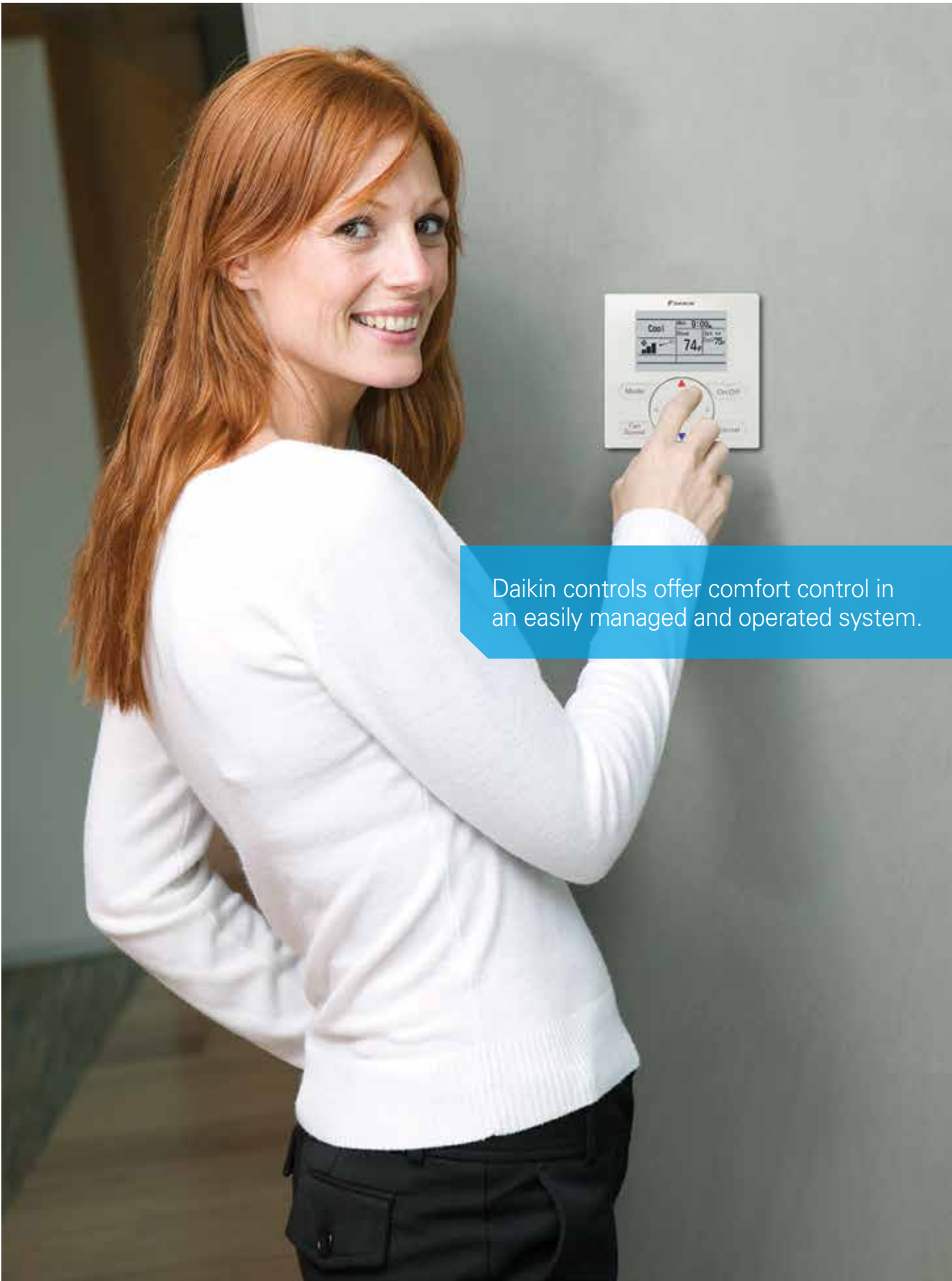

Daikin controls offer comfort control in an easily managed and operated system.

CONTROLS

# VRV Control Systems Overview

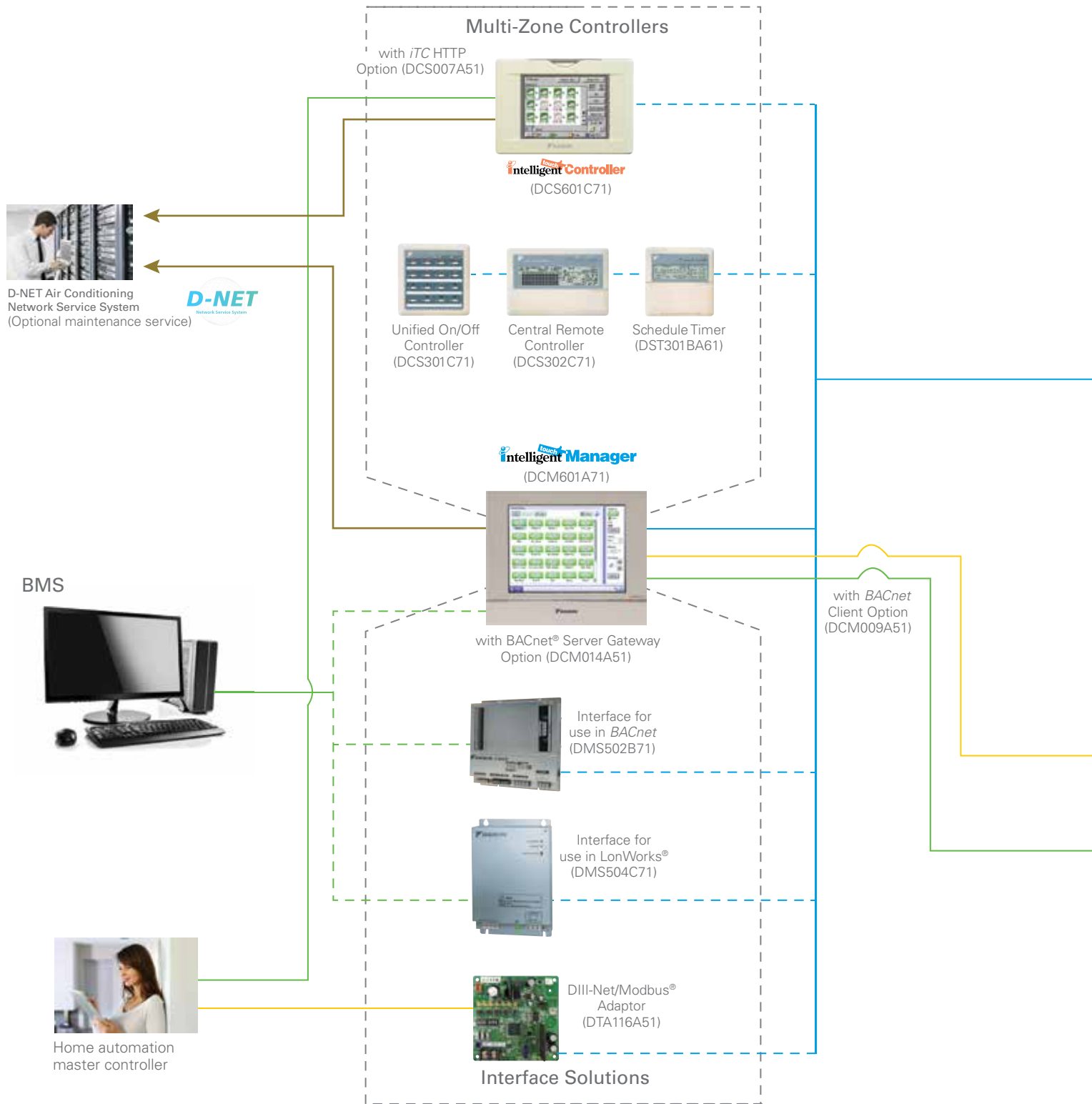

Limitations may apply to some models and functions. Please contact your local sales office for details.

**Note:** BACnet is a registered trademark of the American Society of Heating, Refrigerating and Air-Conditioning Engineers (ASHRAE). LonWorks is a trademark of Echelon Corporation registered in the United States and other countries. Modbus is a registered trademark of Modicon.

- DIII-NET Line
- BACnet/Ethernet or LonWorks network or HTTP communication line
- RS485 Modbus line
- P1P2 line
- Connection line

**DIII-NET**  
(Communications Transmission)

DIII-NET, Daikin's unique communication transmission system, links indoor units and various other building equipment – in accordance with applications, scale and conditions and transmits vast amounts of information between them.

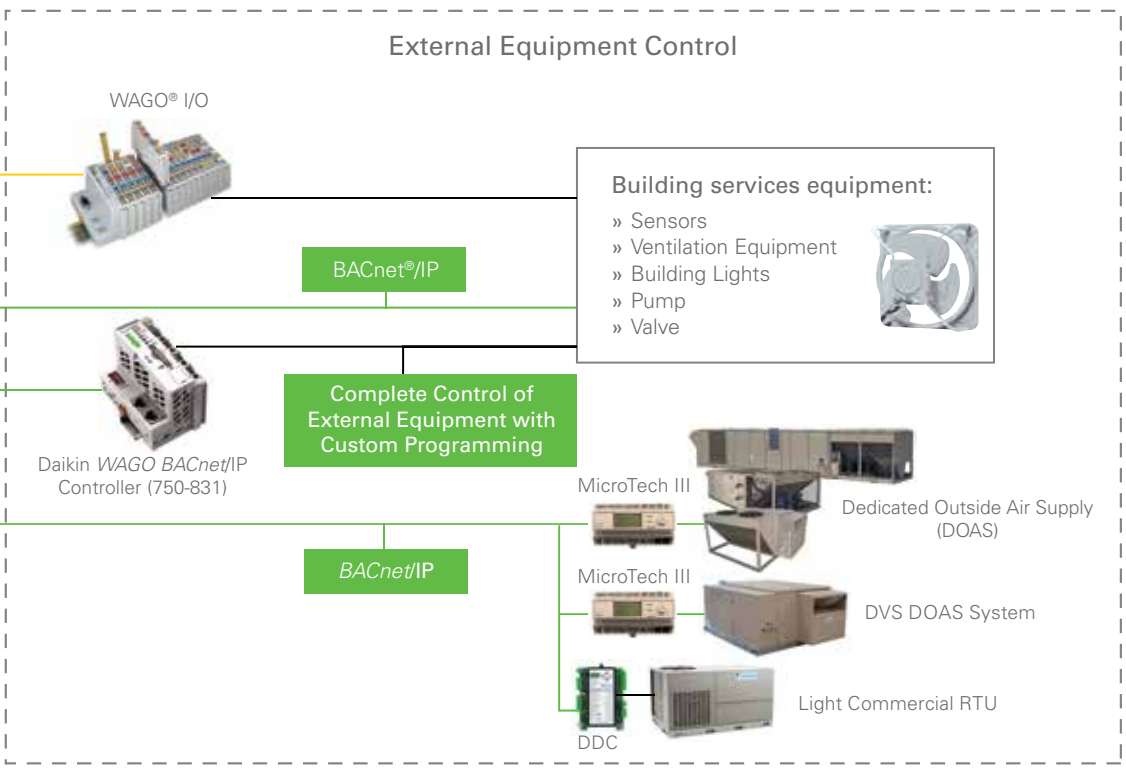
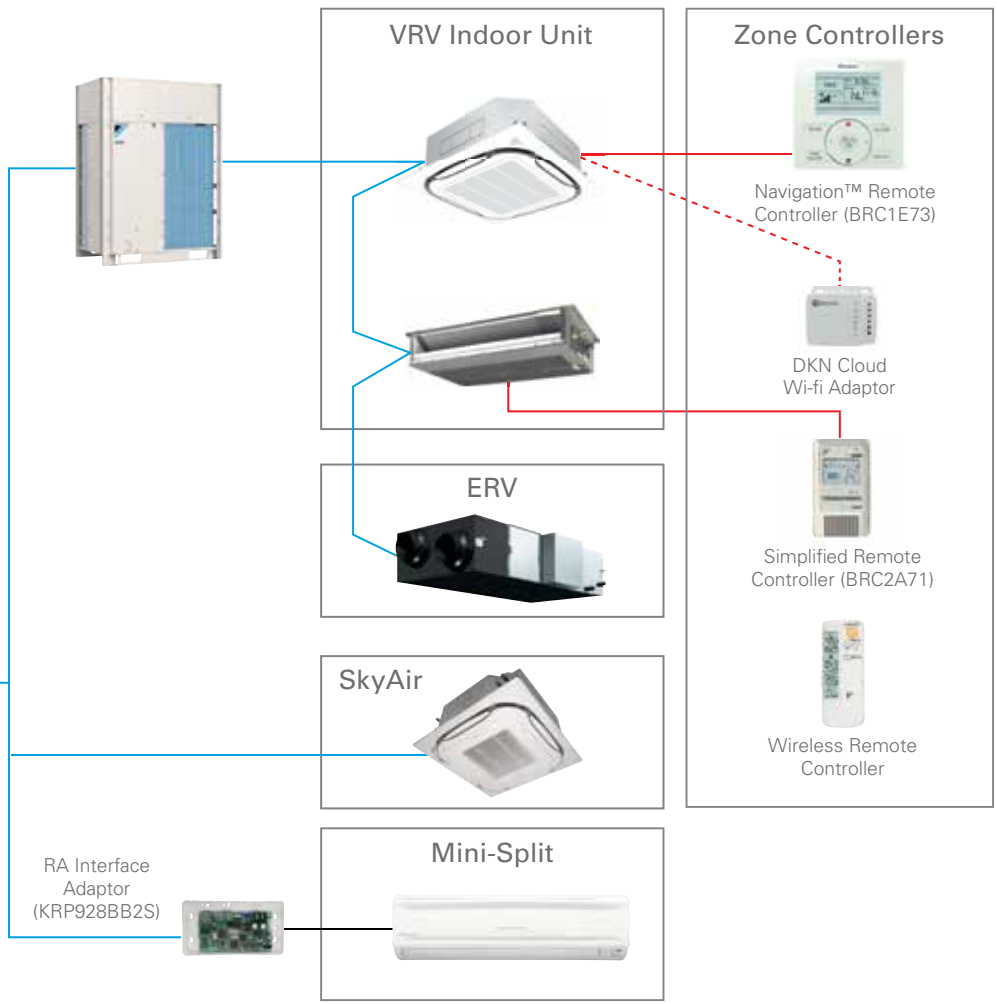

CONTROLS

# Individual Controllers

## BRC1E73 - Navigation™ Remote Controller

The *NAVIGATION* Remote Controller has been enhanced to meet the configuration requirements of Daikin's *VRV* indoor units. The BRC1E73 provides all the great features and options the market requires. The configurable display and operation buttons will provide as much or as little control as the project requires.

### Features and Benefits

#### » Basic Operation

- On/Off, operation mode, setpoint
- Up to 5 fan speeds selectable (enhanced)
- Airflow direction (enhanced)
- Individual louver airflow direction
- Dual airflow
- Auto-draft prevention (prevents air blowing directly on occupants)

#### » Function

- Configurable display — Detailed, Standard, and Simple
- Dual or single cool and heat setpoints for occupied periods
- Independent setback setpoints for unoccupied periods
- Automatic Setback by occupancy sensor
- Automatic Off by occupancy sensor
- Unwanted buttons/operation modes can be disabled
- Setpoint range limitation
- Individual button prohibits/lockout
- Auto-changeover for Heat Recovery and Heat Pump systems with dual or single setpoints
- Self-cleaning filter panel
- Automatic adjustment for Daylight Savings Time (DST) (enhanced)
- Built in 7, 5+2, 5+1+1, and 1 (everyday) schedule with up to 5 actions per day with independent cooling, heating and setback setpoints

#### » More Features

- Backlit display
- Room temperature sensor
- 12/24 hour clock
- Fahrenheit/Celsius selectable
- English/French/Spanish languages selectable
- Remote control group - up to 16 indoor units

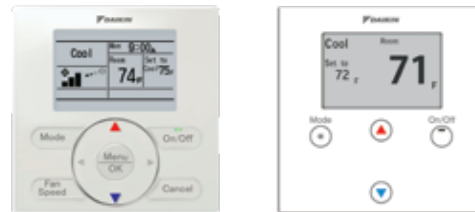

### Auto-changeover

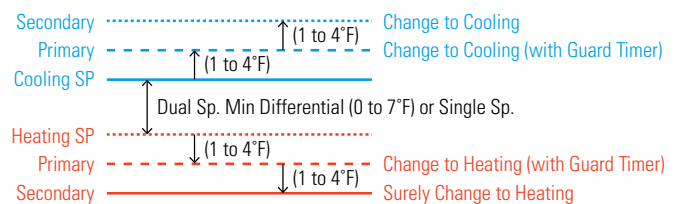

Automatic changeover is available for Heat Pump system and Heat Recovery systems. The setpoint for cooling and heating are configurable with a minimum differential of 0 to 7° F or single setpoint. The changeover is automatically controlled to happen in either of the following two cases:

#### 1. Case 1: Changeover at the primary changeover temperature after the guard timer expires.

- In default, the primary changeover setpoint is 1° F above cooling setpoint or 1° F below heating setpoint, which is configurable between 1° F – 4°F.
- In default, the guard timer is 60 minutes, which is selectable among 15, 30, 60 (default) or 90 minutes.
- The initiation of guard timer is built in to help prevent frequent changeover which may cause energy loss.

#### 2. Case 2: Changeover at the secondary changeover temperature.

- In default, the secondary changeover temperature is 1° F above the primary changeover temperature for cooling or 1°F below the primary changeover temperature for heating, which is configurable between 1° F – 4° F.
- Case 2 will happen while the guard time is active in case 1.



## BRC1E73 - Navigation™ Remote Controller (continued)

### Configurable Display Mode – Detailed, Standard, Simple

DISPLAY MODE	DETAILED	STANDARD	SIMPLE NEW
Display Image			
On/Off status on LED (LED blinks when an error occurs)	■	■	■
Mode	■ <sup>1</sup>	■ <sup>1</sup>	■ <sup>1</sup>
Setpoint (Dual/Single)	■ <sup>2</sup>	■ <sup>2</sup>	■ <sup>2</sup>
Room temperature	■	■	■
Fan speed	■ <sup>3</sup>	■ <sup>3</sup>	■ <sup>3</sup>
Airflow direction (when a louver is available)	■		
Day and Time	■ <sup>3</sup>		
Status icon	■ <sup>3</sup>	■ <sup>3</sup>	
Key lock icon	■	■	
Error message	■	■	

<sup>1</sup> Off can be displayed instead of the operation mode while the unit is turned off with the field setting

<sup>2</sup> Can be removed from the display while the unit is turned off with a field setting

<sup>3</sup> Can be removed from the display with a field setting

### On/Off Display Option



### Optional Face Decals –

Hides unnecessary (locked/prohibited) buttons

USED WITH	SINGLE SETPOINT MODE			DUAL SETPOINT MODE		
Model	 BRC1E72RM	 BRC1E72RF	 BRC1E72RMF	 BRC1E72RM2	 BRC1E72RF2	 BRC1E72RMF2
On/Off	■	■	■	■	■	■
Mode	■	■	■	■	■	■
Fan		■	■		■	■
Up, Down	■	■	■	■	■	■
Left, Right				■	■	■
Menu/Ok						
Cancel						

### Clear display

- » Backlit display
  - Backlight helps operating in dark rooms.
- » Dot matrix display
  - A combination of fine dots enables various icons.
  - Large text display is easy to see.

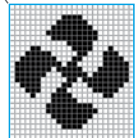
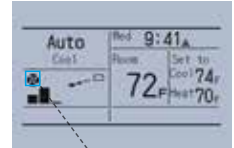

### Simple operation

- » Large buttons and arrow keys
  - Large buttons and arrow keys enable easy operation. Basic setting such as fan speed and temperature can be intuitively operated. For other settings just select the function from the menu list.

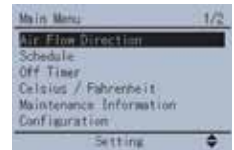

# Individual Controllers (cont.)

## BRC1E73 - Navigation™ Remote Controller (continued)

### Energy saving

» Automatic Off by occupancy sensor†

- The indoor unit will turn off when it is determined that the room is unoccupied after a specified time has elapsed.
- Can be used in conjunction with the Auto Setback by sensor function



» Auto Setback by sensor†

- The cooling and heating setpoints will gradually relax (configurable) internally when the room is determined to be unoccupied.
- The internal setpoint will return to the original setpoint when room occupancy is detected.



Automatic Off energy savings

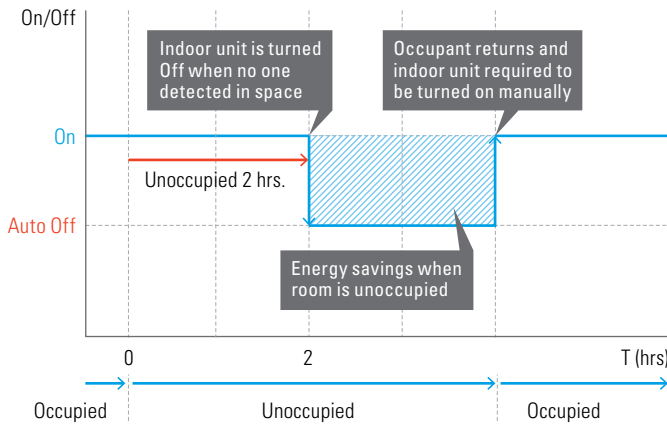

Automatic setback energy savings

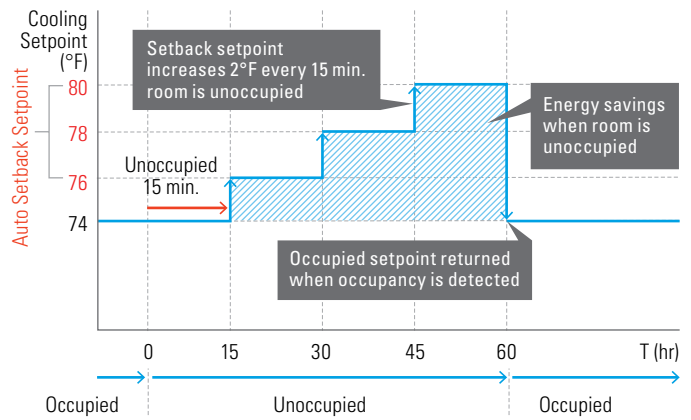

College classroom sample (a summer Monday case)

**1) 8:30 ON**

The first period starts and the air conditioner starts the cooling operation.

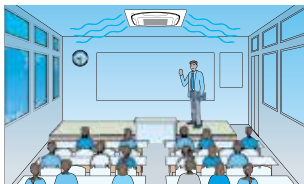

**2) 10:30 OFF**

In the second period, the classroom is unoccupied and the air conditioner stops.

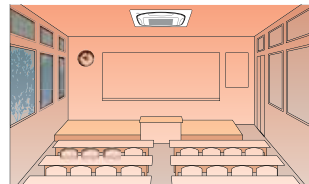

**3) 13:00 ON**

When the third period starts, operation starts again.

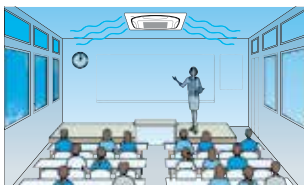

**4) 15:00 OFF**

After the third period, the classroom becomes vacant again and the air conditioner stops.

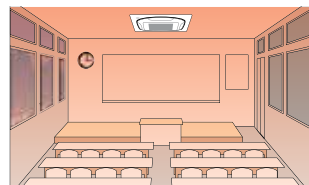

## Comfort

### » Individual airflow direction†

- Airflow direction of each of the four air outlets can be controlled individually.
- (Positions 0 to 4, Swing, and No individual setting are selectable.)

### » Auto airflow rate†

- Airflow rate is automatically controlled in accordance with the difference between room temperature and set temperature.

† Only available for VRV 4-Way Flow Ceiling Suspended type FXUQ\_P series and Ceiling Mounted Cassette (Round Flow with Sensing) type FXFQ\_T series.

Individual airflow direction

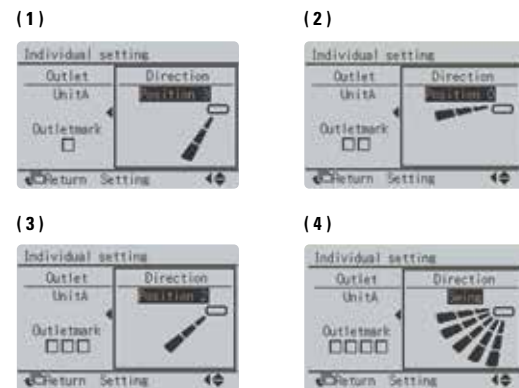
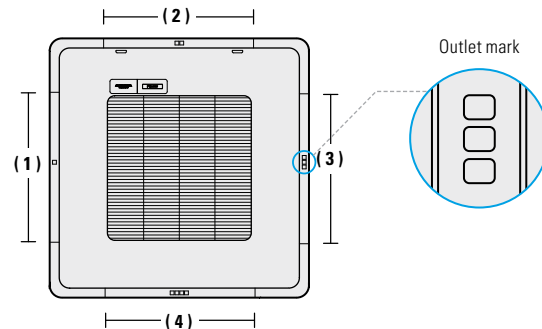

With 18 configurable airflow distribution patterns, the controls aid efficiency and provides a comfortable environment.

# Individual Controllers (cont.)

## BRC4C82/BRC7E818/BRC7E83/BRC7E830 - Wireless Remote Controller

- » The same operation modes and settings as with wired remote controllers are possible.
    - Individual airflow direction, auto airflow rate and sensing sensor control can be set only via wired remote controller BRC1E73. Cannot be set via other remote controllers.
  - » A compact signal receiver unit (separate type) to be mounted into a wall or ceiling is included.
    - The Ceiling Suspended and Wall Mount indoor units use signal receivers that are mounted in the indoor unit.
- \* Wireless remote controller and signal receiver unit are sold as a set.

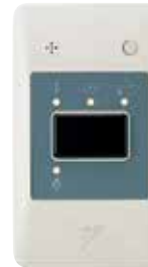

Signal receiver unit\*  
(separate type)



Wireless remote\*  
controller

## BRC2A71 - Simplified Remote Controller

- » Economical controls solution
- » Suitable for use in hotels rooms, hallways, reception areas and conference rooms
- » Features
  - On/Off
  - Operation mode
  - Single setpoint
  - Fan speed adjustment
  - Can be used with the optional remote temperature sensor for sensing room temperature



Simplified remote  
controller

## AZAI6WSCDKA-DKN Cloud Wi-Fi Adaptor

- » Remote control of VRV indoor units from iOS/Android smartphone app
- » A Navigation remote controller must be used together with the Wi-Fi adaptor
- » Features
  - On/Off
  - Mode
  - Setpoint
  - Fan speed
  - Room temperature
  - Error alert
  - Leveled user authority



DKN Cloud  
Wi-fi Adaptor

## Summary

REMOTE CONTROLLER COMPATIBILITY WITH VRV/INDOOR UNITS											
	FXFQ_TV	FXZQ	FXUQ	FXDQ	FXSQ	FXMQ	FXHQ	FXAQ	FXL(N)Q	FXTQ	FXEQ
Navigation™ remote controller (Wired remote controller)	■	■	■	■	■	■	■	■	■	■	■
Wireless remote controller (Installed type signal receiver unit)		■					■	■			
Wireless remote controller (Separate type signal receiver unit)				■	■	■			■		
Simplified remote controller	■	■	■	■	■	■	■	■	■	■	■
DKN Cloud Wi-Fi Adaptor	■	■	■	■	■	■	■	■	■	■	■

■ No lower control function

INDIVIDUAL CONTROL CAPABILITIES				
System Capabilities	Daikin Controls Options			
	DKN Cloud Wi-Fi Adaptor (AZA16WSCDKA)	BRC1E73 Navigation™ Remote Controller	BRC2A71 Simplified Wired Remote Controller	Wireless Remote Controller (model depends on unit)
Communications	2 Wire / DIII Net	2 Wire / DIII Net	2 Wire / DIII Net	Infrared
°F/°C Selector	■	■	°F only	°F only
Backlit LCD display		■		
Room temperature display	■	■		
Schedule and setback capabilities (with Time and Date display)	■	■		
User restriction options		■		
On/Off, Operation mode, Setpoint, Fan speed	■	■	■	■
Louver position adjustment		■		■
Reports system malfunctions	■	■	■	■
Space temperature sensor	■	■		
Simultaneous operation with Daikin multi-zone controllers	■	■	■	■
Simultaneous operation with BACnet® and LonWorks®	■	■	■	■
Group control capacity	Up to 16 indoor units	Up to 16 indoor units	Up to 16 indoor units	Up to 16 indoor units

By providing individual zone control, the occupant of each space has the ability to set the room temperature where they feel most comfortable.



# Advanced Multi-Zone Controllers

## DCM601A71 - intelligent Touch Manager™ (iTM)

The *intelligent Touch Manager (iTM)* is an advanced multi-zone controller that provides the most cost-effective way to control and monitor the Daikin VRV system.

### Centralized and Advanced VRV Control

Up to 64 Indoor Unit Groups (128 actual Indoor Units) can be monitored and controlled with individual Cool and Heat Setpoints, Setpoint Range Limitation, Setback Setpoints, and Auto changeover to meet your expectations and project requirements. Up to 512 Indoor Unit Groups (1024 actual Indoor Units) can be monitored and controlled with the addition of up to 7 optional *iTM* Plus Adaptors (DCM601A72).

### Built-in Service Tool with Remote Access

- » Operation data are stored in the iTM for the last 5 days:
  - Indoor unit and outdoor unit operation data
  - BACnet Client objects
  - WAGO I/O system data
- » Operation data can be exported through a USB drive or through the iTM web browser remotely
- » BMS can monitor the BACnet objects of indoor unit and outdoor unit operation data with the BACnet Server Gateway Option activated

### Ancillary Equipment Control

Integrates and/or interlocks sensors, switches, dampers, fans, pumps, and lighting with Daikin Indoor Units.

### Web Access and Alert E-mail

Allows daily remote monitoring and control with the Web/E-mail function that can be accessed via the facility's Local Area Network or your Internet connection. Sends Error E-mail to mobile devices with the Web/E-mail function.

### Tenant Billing

Determines energy consumption of shared condensing units based upon tenant (Indoor Unit) demand using the PPD Software option (DCM002A71).

### Features

- » 10.4" LCD touch screen, USB drive
- » Advanced, scalable and cost-effective management system
  - Up to 650 points (max 512 indoor unit groups (1024 indoor units)
  - Floor plan layout view

### Functions

- » Dual setpoints or Single setpoint in Occ or Setback in Unocc
- » Setpoint Range Limitation



**intelligent Touch Manager**

- » Scheduling (7 day, Weekday-Weekend, Weekday-Saturday-Sunday, Everyday)
- » Optimum Start and Timed Override
- » Advanced Auto changeover
  - Applicable to both VRV Heat Pump and Heat Recovery systems
  - Fixed, Individual, Average and Vote methods
- » Web Accessibility and Alert Email (standardized)
  - All screen views and configuration menus can be accessed through Web
- » WAGO® I/O
  - Monitor and control 3rd party equipment with DI, DO, AI and AO signals
  - Up to 512 management points
  - Interlock function with indoor units and ancillary equipment
- » Power Proportional Distribution Option (DCM002A71)
  - Calculates apportionment of outdoor unit's total power consumption to individual units on the system
- » iTM BACnet® Client Option (DCM009A51)
  - Enabling the *BACnet* Client option allows the *iTM* to use the *BACnet* IP protocol
  - Allows for full monitoring and control of 3rd party *BACnet* capable equipment
  - Up to 512 *BACnet* management points
- » iTM BACnet Server Gateway Option (DCM014A51)
  - Enable BMS to control indoor units and/or monitor outdoor unit operation via BACnet/IP (up to a total of 128 BACnet device IDs and 4000 BACnet objects)
  - Virtual router function embedded that enables individual and configurable BACnet device ID for each indoor unit group address and each outdoor unit.

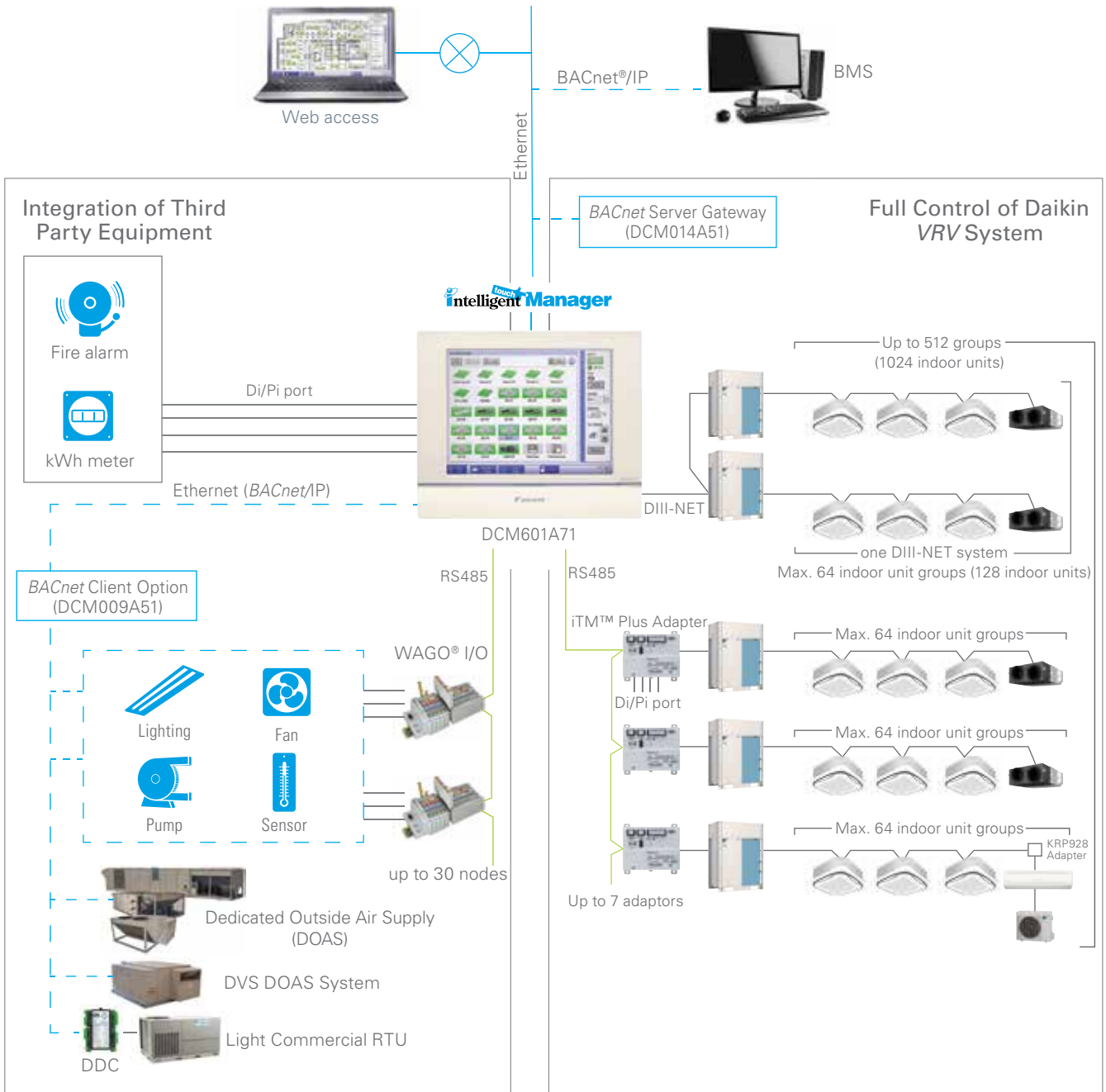

CONTROLS

# Advanced Multi-Zone Controllers (cont.)

## DCS601C71 – intelligent Touch Controller™ (iTC)

### Centralized and Advanced VRV Control

Up to 64 Indoor Unit Groups (128 actual Indoor Units) can be monitored and controlled with individual Cool and Heat Setpoints, Setpoint Range Limitation, Setback Setpoints, and Auto changeover to meet your expectations and project requirements. Up to 128 Indoor Unit Groups (256 actual Indoor Units) can be monitored and controlled with the addition of the Optional DIII-Net Plus Adaptor (DCS601A72).

### Ancillary Equipment Control

Integrates and/or interlocks sensors, switches, dampers, fans, pumps, and lighting with Daikin Indoor Units.

### Web Access and Alert E-mail

Allows daily remote monitoring and control with the Web/E-mail Software option that can be accessed via the facility's Local Area Network or your Internet connection. Sends Error E-mail to mobile devices with the optional Web/E-mail Software option (DCS004A71).

### Tenant Billing

Determines energy consumption of shared condensing units based upon tenant (Indoor Unit) demand using the PPD Software option (DCS002A71).

### Features

- » Color LCD touch panel icon display
- » Simplified engineering
- » Multi language (English, French, Italian, German, Spanish)
- » Yearly schedule
- » Independent dual or single setpoints for occupied and setback operation
- » Auto heat/cool changeover
- » Enhanced history function
- » Simple Interlock Function
- » Doubling of number of connectable indoor units by adding a DIII-NET Plus Adaptor (option)



**intelligent** touch **Controller**

### Functions

- » Advanced Zone Level Control
  - Add advanced temperature control functions from a single multi-zone controller
- » Independent Cool, Heat, and Setback Setpoints
- » Advanced Auto changeover
  - Applicable to both VRV Heat Pump and Heat Recovery systems
  - Fixed, Individual, and Average methods
- » Scheduling (7 day, Weekday-Weekend, Weekday-Saturday-Sunday)
- » Centralized Control with three different view styles
- » Setpoint Range Limit
- » Simple interlock
- » PPD (tenant billing option) (DCS002A71)
- » Web server/alarm email (DCS004A71)
- » HTTP interface (option) (DCS007A51)





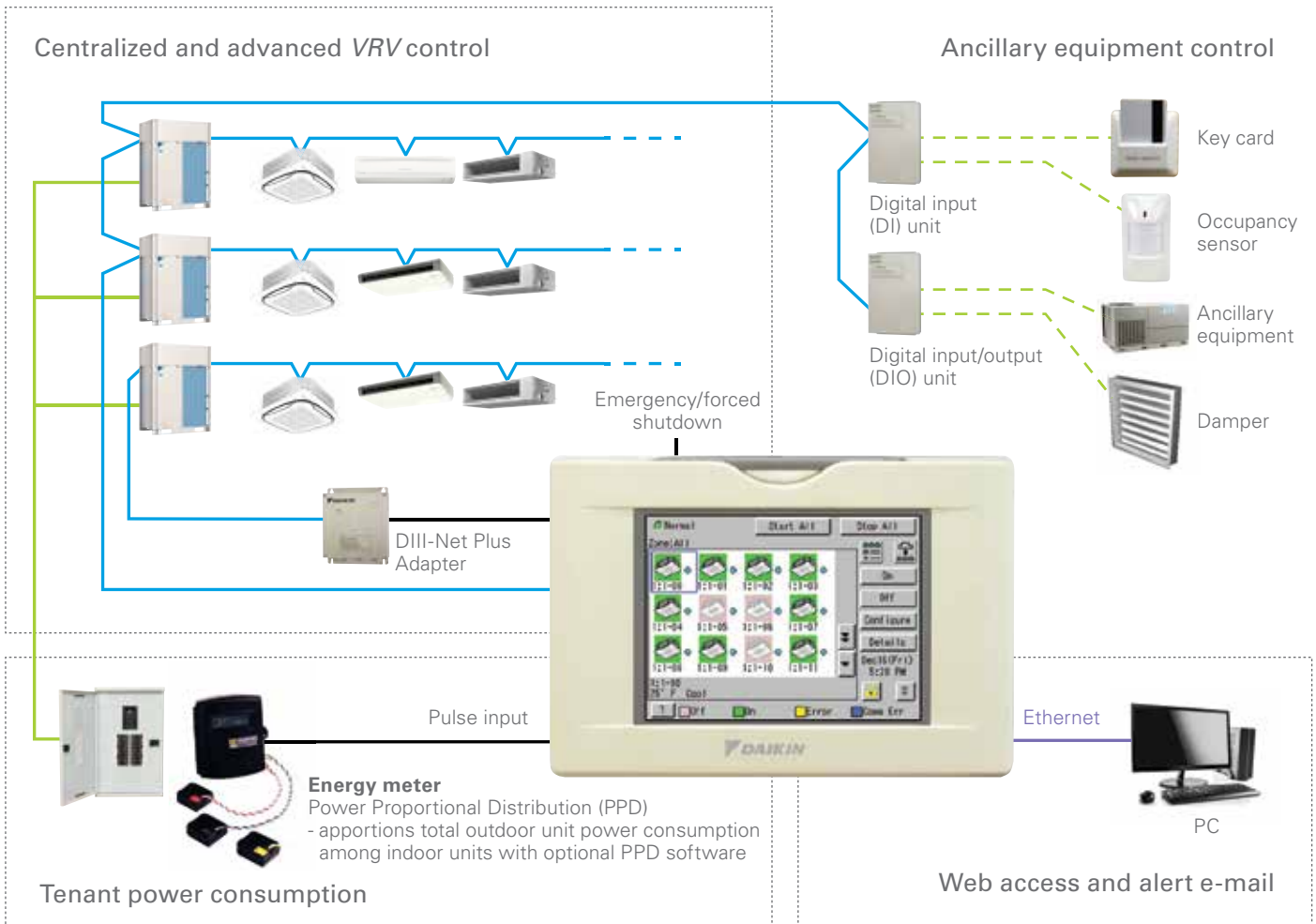

CONTROLS

# Centralized Controllers

## DCS302C71 - Central Remote Controller

Maximum 64 groups (zones) of indoor units can be controlled individually.



- » Maximum 64 groups (128 indoor units) controllable
- » Maximum 128 groups (128 indoor units) are controllable by using 2 Central Remote Controllers, which can control from 2 different places.
- » Zone control
- » Malfunction code display

- » Maximum wiring length 3280 ft. (Total: 6560 ft.)
- » Connectable with Unified ON/OFF Controller, Schedule Timer and BMS system
- » Airflow volume and direction can be controlled individually for indoor units in each group operation.
- » Ventilation volume and mode can be controlled for Energy Recovery Ventilator.
- » Up to 4 ON/OFF pairs can be set per day by connecting a schedule timer.



### DCS301C71 - Unified On/Off Controller

Maximum 16 groups of indoor units can be operated simultaneously/individually.

- » Maximum 16 groups (128 indoor units) controllable
- » Operating status indication (Normal operation, Alarm)
- » Centralized control indication
- » Maximum wiring length 3280 ft. (total: 6560 ft.)
- » Compact size casing (thickness: 0.63in)
- » Connectable with Central Remote Controller, Schedule Timer and BMS system



### DST301BA61 - Schedule Timer

Maximum 128 indoor units can be operated by programmed schedule.

- » Maximum 128 indoor units controllable
- » When used in combination with a Central Remote Controller, a maximum of 8 weekly schedule patterns can be set, while the Central Remote Controller can be used to select desired zones. Up to 2 ON/OFF pairs can be set per day.
- » Maximum 48 hours back up power supply
- » Maximum wiring length 3280 ft. (total: 6560 ft.)
- » Compact size casing (thickness: 0.63in)
- » Connectable with Central Remote Controller, Unified ON/OFF controller and BMS system



The Central Controllers can monitor and control indoor units by either group or zone. Their easy-to-read liquid crystal displays (LCDs) allow you to orchestrate and monitor temperature, time, and airflow volume, etc. across your entire system at the touch of button.

CONTROLS

# External Equipment Control

## DCM009A51 - iTM BACnet® Client Option

The *iTM* offers an advanced and cost-effective solution for Building Management Systems (BMS) applications. The *iTM* BACnet Client Option (DCM009A51) provides more flexibility to enhance the *iTM*'s function as a mini BMS. With this option, the *iTM* is able to manage DOAS systems and other third party equipment through the BACnet/IP protocol. By registering equipment connected to a BACnet server as management points in the *iTM*, you can now monitor and control the equipment via the *iTM*.

## Features

- » Cost-effective BMS solution
- » Direct connection on *iTM* using the BACnet/IP Protocol
- » Integrated control on Daikin VRV system and Daikin Applied System
- » Monitors and controls third party equipment
- » Easy commissioning with pre-engineering Preset Tool
- » Easy monitoring with preconfigured GUI

## Intelligent Manager

with BACnet® Client Option

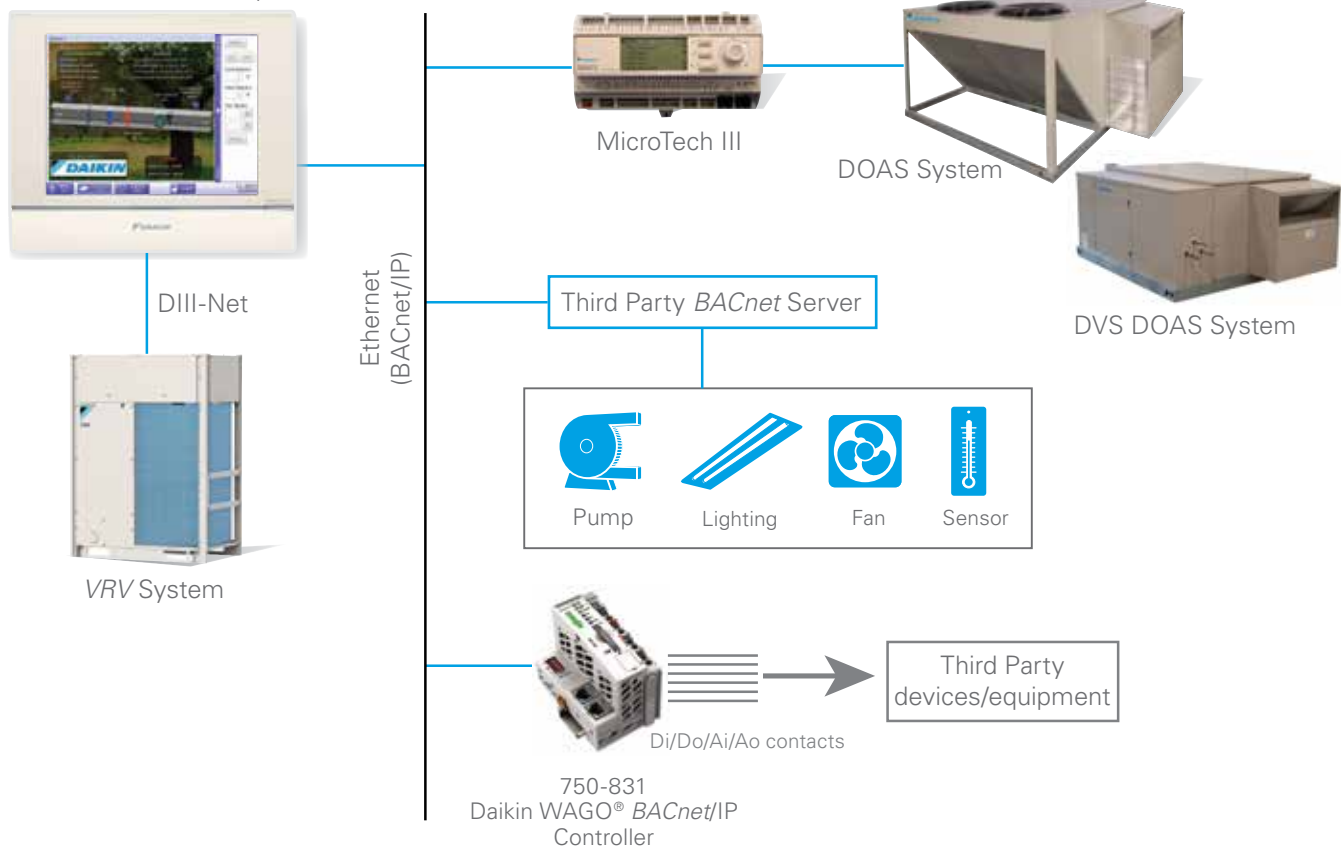

## Object Types

- » Analog Input, Analog Output, Analog Value
- » Binary Input, Binary Output, Binary Value
- » Multi-State Input, Multi-State Output, Multi-State Value

## Applications

- » Simple I/O: Sensor, Pump, Light, Fan
- » Multi-State Objects: AHU, Alarm, Elevator
- » The *iTM* can integrate with the WAGO® BACnet/IP Controller (750-831) using the BACnet Client Server Option

## 750-831 - Daikin WAGO® BACnet®/IP Controller

The Daikin WAGO BACnet/IP Controller (750-831) is a programmable controller that connects the WAGO I/O system to the BACnet protocol. This controller provides the three following functionalities:

- » Native server: BACnet objects are generated automatically for the DI, DO, AI, AO modules that are connected to the controller.
- » Application server: Other supported BACnet objects can be created via programming and made available to a BACnet network.
- » Application client: Using the client functionality, BACnet objects and the properties of the external equipment can be accessed.



750-831  
Daikin WAGO BACnet/IP  
Controller

Daikin's VRV Marketing Controls Group will provide customizable programming (programming and commission fees apply) for applications where external equipment control is needed. The following application programs are now available:

- » Water-Cooled VRV Valve Control: Valve control for Water-Cooled VRV project
- » Ambient Enclosure Heater Control: Damper and auxiliary heater control for outdoor unit dog house projects in cold climate
- » Trending: Trending Client for VRV
- » Custom programming available to fit individual project needs

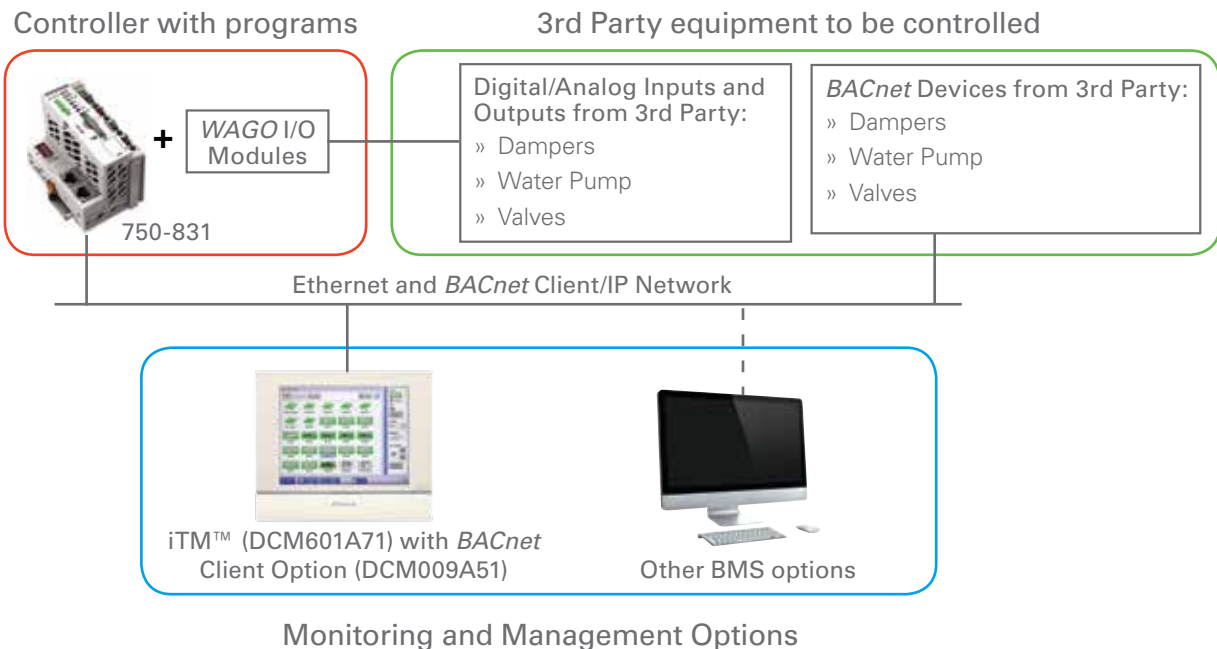

## DCM014A51 - iTM™ BACnet® Server Gateway Option

The *intelligent Touch Manager* is capable of serving as a *BACnet* interface for Building Management System (BMS) integration. With the *iTM BACnet* Server Gateway Option (DCM014A51), the *iTM* provides BMS integrators with the ability to monitor and/or control the *VRV* indoor and outdoor units, eliminating the need for an additional hardware interface. Moreover, with the latest software update to the *iTM 2+* (v2.06), the *iTM* is able to serve as a service tool to access indoor and outdoor unit operation data. With the *iTM BACnet* Server Gateway Option, the operation data points for both the IDU (indoor unit) and ODU (outdoor unit) are also available to the BMS through *BACnet*.

### Features

- » Additional service data points are now available\*:
  - 6 new IDU service data points
  - 9 new common ODU service data points and 22 new service data points for each ODU module
- » Direct connection on *iTM* using the *BACnet*/IP Protocol
- » Supports Change of Value (COV) notifications to the BMS
- » Configurable as a *BACnet* foreign device if a BBMD exist on a different subnet within a *BACnet* network
- » *BACnet* virtual router function implemented:
  - Individual *BACnet* device ID assigned to each indoor unit group address and each outdoor unit
  - Indoor unit group names created in the *iTM* are visible on the BMS
- » Easy commissioning using CSV file
  - Available objects can be configured for each indoor unit
- » Independent heating and cooling setpoints for occupied and unoccupied periods
- » Individual min/max *Setpoint Range Limitation* for heat and cool modes
- » The *iTM*'s auto changeover, setpoint range limitation, setback, dual setpoint logic and schedule can be accessed by the BMS
- » Up to 128 Device IDs (including both indoor units and outdoor units) and up to 4000 *BACnet* objects can be monitored and controlled by BMS.
  - When the IDU/ODU operation data is enabled a total of 128 devices and 4000 *BACnet* points are available
- » Up to 7 *iTM* Plus Adaptors can be connected to an *iTM* for a total of 8 DIII-Net ports

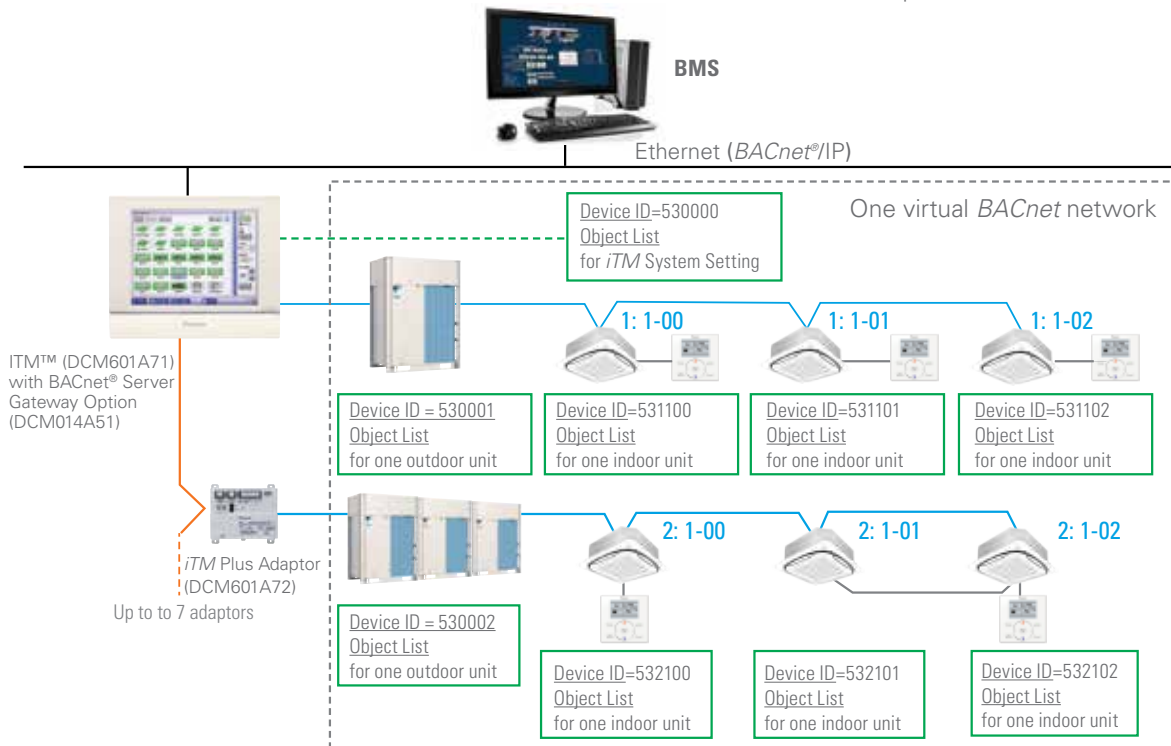

## Powerful Service Tool with Indoor and Outdoor Unit Operation Data Points

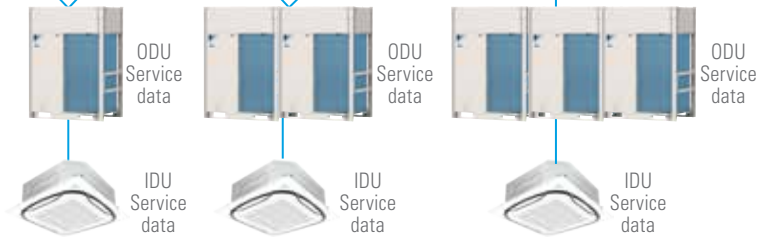

- » When a problem occurs, the BMS integrators and Service Technicians can start troubleshooting immediately before going to the site.
  - » Indoor and outdoor operation data trending\* by BMS can benefit the VRV service process.
- \*BMS programming needed

## Enhanced BMS Integration Solution for Indoor Unit Operation



**Individual Device instance number for each indoor unit (Configurable)**

Device ID (1:1-00) = 531100    Device ID (1:1-01) = 531101

**Object instance number repeated for every indoor unit point**

Occupancy Mode = MO 1 (All indoor units)  
Unit On Off Status = BI 2 (All indoor units)

### Advanced iTM™ BACnet® Server Gateway Points

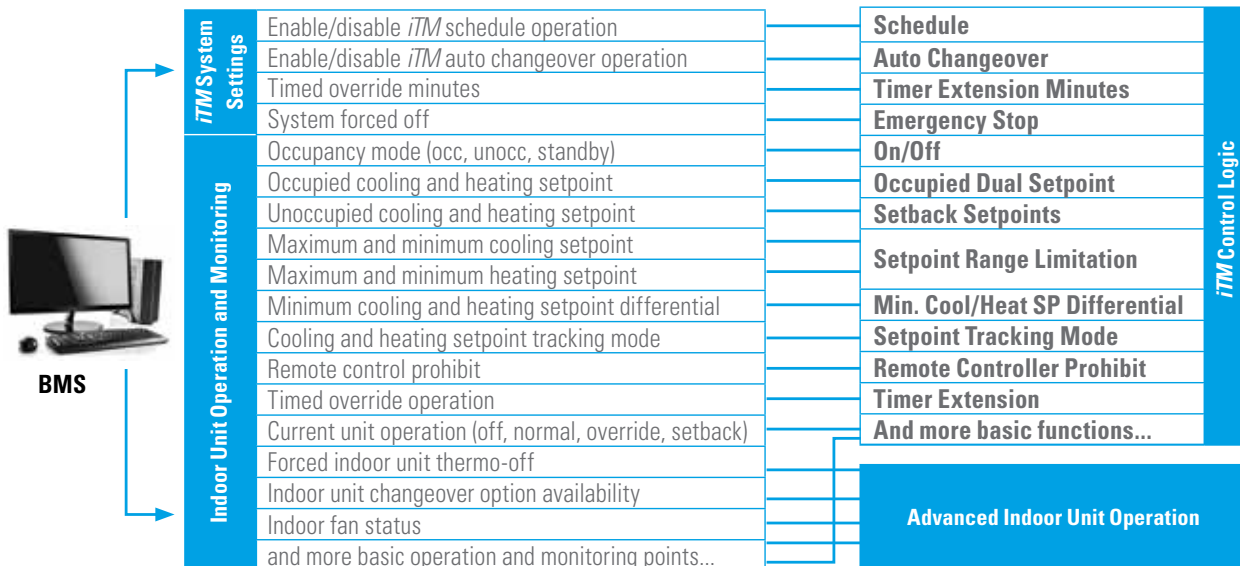

CONTROLS

# Interface Solutions (cont.)

## DMS502B71 - Interface for use in BACnet®

- » *BACnet*: Building Automation and Control Networks
  - Standard open protocol based on ANSI/ASHREA Standard 135
- » Monitor/Control indoor unit's points
- » Monitor/Control up to 256 indoor units groups (512 indoor units)
- » Certified by *BACnet* Testing Laboratories (BTL)
- » Manage up to 4 DIII-Net systems
  - Option Board (DAM411B51) required



## DMS504C71 Interface for use in LonWorks®

- » BMS interface based on LonTalk
- » Interface between Daikin DIII-Net and BMS LonTalk work station
  - Manages up to 64 indoor unit groups (128 indoor units) with network variables for each group
  - Manages 1 DIII-Net system
- » Lon Interface communicates over twisted pair wire
- » External Interface File (XIF) documents device information available at [www.daikinac.com](http://www.daikinac.com)

*BACnet, LonWorks and Modbus®* Interface overview

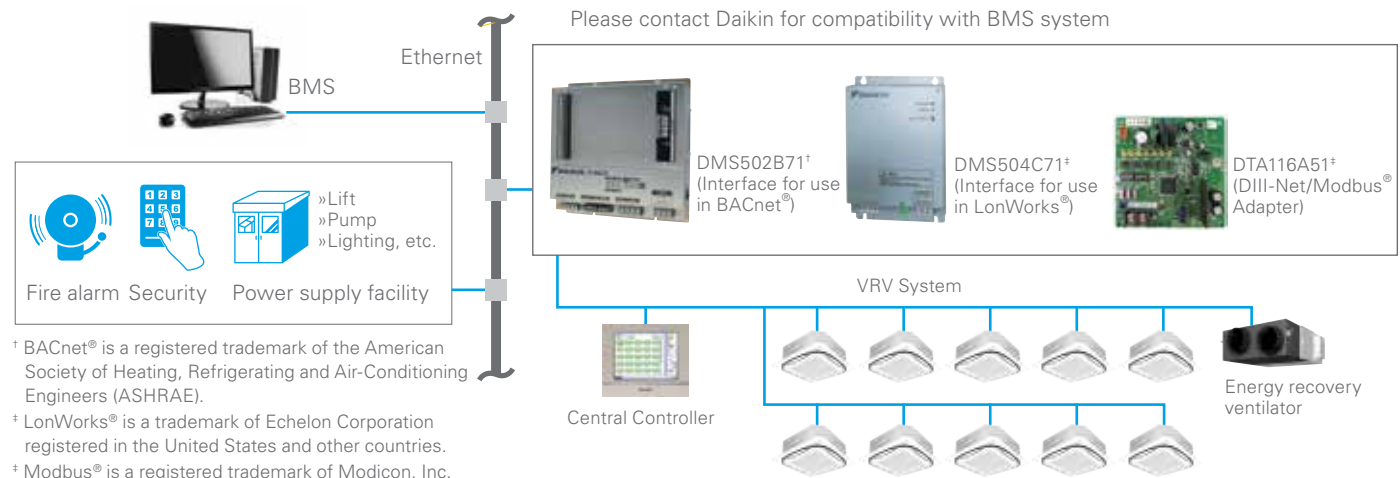

Daikin's *BACnet, LonWorks and Modbus* interface units provides control for all *VRV* systems.

## DTA116A51 - DIII-Net *Modbus* Adaptor

- » BMS interface based on *Modbus* (RS485)
- » Gateway between Daikin DIII-Net and BMS *Modbus* workstation
  - Manages up to 16 *VRV* indoor units connected to up to 2 outdoor units
- » *Modbus* interface communicates via *Modbus* RTU



## D-NET Air Conditioning Network Service System

Save energy. Protect your equipment investment. Maintain comfort levels.



D-NET connects your equipment to our monitoring center over the web. We continually monitor more than 80 data points in your equipment\*, so we know exactly how your systems are performing. We also monitor outside

conditions from more than 400 locations across the United States and Canada, so we know what kind of weather you're up against. Putting this information together, we know if your systems can be optimized remotely to reduce your energy consumption.

D-NET Air Conditioning Network Service System overview

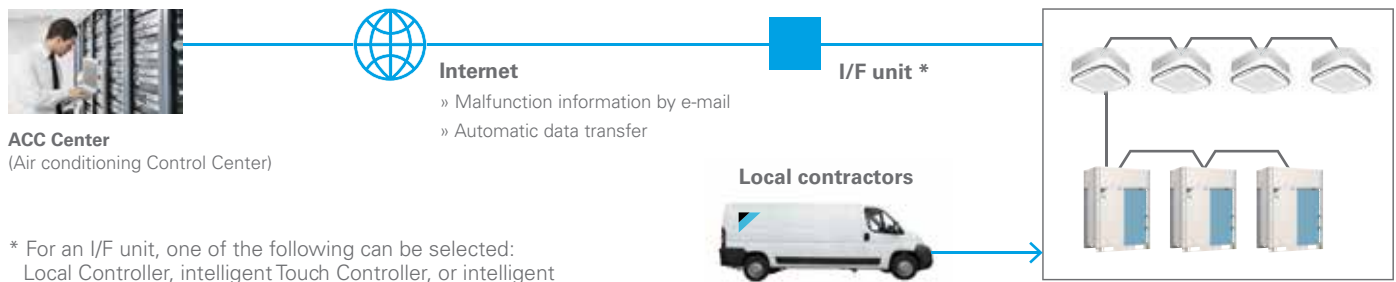

\* For an I/F unit, one of the following can be selected:  
Local Controller, intelligent Touch Controller, or intelligent Touch Manager.



# Controls Product List

## Individual Controllers

ITEM	MODEL NO.	FUNCTION
Navigation™ Remote Controller	BRC1E73	Programmable zone controller
DKN Cloud Wi-Fi Adaptor	AZAI6WSCDKA	Remote control by smartphone app
Wireless Remote Controller	BRC4C82 BRC7C812 BRC7E818 BRC7E83 BRC7E830	Hand-held zone controller with infrared receiver kit
Simplified Remote Controller	BRC2A71	Non-programmable zone controller

## Multi-Zone Controllers and Options

ITEM	MODEL NO.	FUNCTION	
<i>intelligent Touch Manager</i>	intelligent Touch Manager™	DCM601A71	Air-conditioning management system that can be controlled by touch screen or web browser to monitor and control up to 64 groups (10 outdoor units)
	iTM™ Plus Adaptor	DCM601A72	Maximum of 7 iTM Plus Adaptors can be connected to intelligent Touch Manager. Each iTM Plus Adaptor can add up to 64 additional groups (10 outdoor units)
	iTM PPD Option	DCM002A71	Power consumption of indoor units are calculated based on operation status of the indoor unit and outdoor unit power consumption measured by kWh meter
	iTM BACnet® Client Option	DCM009A51	The BACnet Client Option enables the iTM to control and monitor equipment through the BACnet/IP protocol
	iTM BACnet Server Gateway Option*	DCM014A51	The BACnet Server Gateway Option provide BMS integrators with the ability to monitor and control the VRF indoor units via the BACnet/IP protocol.
<i>intelligent Touch Controller</i>	<i>intelligent Touch Controller</i>	DCS601C71	Air-Conditioning management system that can control up to 64 groups (10 outdoor units).
	DIII-Net Plus Adaptor	DCS601A72	Additional 64 groups (10 outdoor units) are possible.
	iTC™ PPD Option	DCS002A71	Power consumption of indoor units are calculated based on operation status of the indoor unit and outdoor unit power consumption measured by kWh meter.
	iTC Web Option	DCS004A71	Provides access to iTC via web browser with PC. Error Email sent when errors occur.
	iTC HTTP Interface Option	DCS007A51	Interface to home automation system certified with Crestron Home Automation
Central Remote Controller	DCS302C71	Up to 64 groups of indoor units (128 units) can be connected, and ON/OFF, temperature setting and monitoring can be accomplished individually or simultaneously. Connect up to 2 controller in one system.	
Unified ON/OFF controller	DCS301C71	Up to 16 groups of indoor units (128 units) can be turned, ON/OFF individually or simultaneously, and operation and malfunction status can be displayed. Can be used in combination with up to 8 controllers.	
Schedule Timer	DST301BA61	Weekly schedule can be programmed by the controller for up to 64 groups of indoor units (128 units). Can turn units ON/OFF twice per day.	

\*iTM BACnet Server Gateway Option is not compatible with iTM PPD option and iTM BACnet Client option.

## Hardware Interface Solutions

ITEM	MODEL NO.	FUNCTION
Interface for use in BACnet	DMS502B71	Interface unit to allow communications between VRF and BMS. Operation and monitoring of air-conditioning systems through BACnet/IP communication.
Optional DIII board	DAM411B51	Expansion kit, installed on DMS502B71, to provide 2 more DIII-NET communication ports. Not usable independently.
Interface for use in LonWorks®	DMS504C71	Interface unit to allow communications between VRF and BMS. Operation and monitoring of air-conditioning systems through LonWorks communication
Interface for use in Modbus®	DTA116A51	Use of the Modbus protocol enables the connection of the VRF system with a variety of home automation and BMS systems from other manufacturers.

## Adaptors

ITEM	MODEL NO.	FUNCTION
Digital Input (Di) Unit	DEC101A51-US2	Monitor On/Off and Error status of ancillary equipment
Digital Input/Output (Dio) Unit	DEC102A51-US2	Monitor and control of ancillary equipment
DIII-Net Expander Adaptor	DTA109A51	Apply to increase the number of outdoor units (up to another 10) connected in one DIII-Net system. Apply to overcome communication errors in electrically noisy environments.
Unification Adaptor for Computerized Control	DCS302A72	Turn On/Off the system from a central panel through Centralized Controller or iTouch Controller. Monitor On/Off and Error Status.
External control Adaptor for Outdoor Unit	DTA104A53/61/62	Unified changeover of Cool/Heat mode. To change the mode of several outdoor units by one remote controller. Demand Control. Low Noise Control: -2 to 3 dB of outdoor unit
Group Control Adaptor	KRP4A71/72/73/74	Turn On/Off Remote Control Group. Change setpoint (with resistance interface 0-135 ohm). Monitor On/Off and Error status
ABC Terminal Kit	BRP2A81	Remotely manage the operating mode of the heat pump system. Integration point for ambient thermostats to engage lock-out
Wiring Adaptor	KRP1C74/75	Thermo-on status. Fan status. AUX heater output. Humidifier output
RA Interface Adaptor for DIII-Net Use	KRP928B2S	Mini-split can be controlled through DIII-NET
RA PCB Adaptor for Time Clock	KRP413A1S	Remotely Start / Stop for mini-split indoor units

## WAGO® I/O System

MODULE	PART NUMBER	DESCRIPTION	
Basic Kit	60359653	Bus Coupler, Connector, 24 VDC Power Supply, and End Module	
Digital Input	2 Channel DI	750-400	2 Channel Digital Input Module, 24 VDC
	4 Channel DI	750-432	4 Channel Digital Input Module, 24 VDC
	8 Channel DI	750-430	8 Channel Digital Input Module, 24 VDC
Digital Output	2 Channel DO	750-513/000-001	2 Channel Digital Output Module, without power jumper
	4 Channel DO	750-504	4 Channel Digital Output Module, 24 VDC
Analog Input	2 Channel AI	750-454	2 Channel Analog Input Module, 4-20 mA, Differential Inputs
		750-479	2 Channel Analog Input Module, ± 10 VDC, Differential Measurement Input
	4 Channel AI	750-461/020-000	2 Channel Analog Input Module, NTC 20k Ohm
		750-455	4 Channel Analog Input Module, 4-20 mA, single-ended
		750-459	4 Channel Analog Input Module, 0-10 VDC, single-ended
Analog Output	2 Channel AO	750-554	2 Channel Analog Output Module, 4-20 mA
		750-550	2 Channel Analog Output Module, 0-10 VDC
	4 Channel AO	750-555	4 Channel Analog Output Module, 4-20 mA
		750-559	4 Channel Analog Output Module, 0-10 VDC
Internal System Power Supply	750-613	24 VDC Bus Power Supply Module, Required for use after every 32 contact points connected in a node	
Passive Power Supply	750-602	24 VDC Power Supply Module, passive	
24 VDC Jumper	750-603	24 VDC Power Jumper Module, for use with 8 channel DI module	

## Daikin WAGO® BACnet®/IP Controller and Parts

PART NUMBER	NAME	DESCRIPTION
750-831	Daikin WAGO BACnet/IP Controller	WAGO BACnet/IP Controller
759-302/000-923	WAGO I/O Check USB kit	WAGO I/O Check CD ROM and service cable
787-712	24 VDC Power Supply	24 VDC Power Supply
750-600	End Module	WAGO End Module





# Support and Tools

# Support and Tools

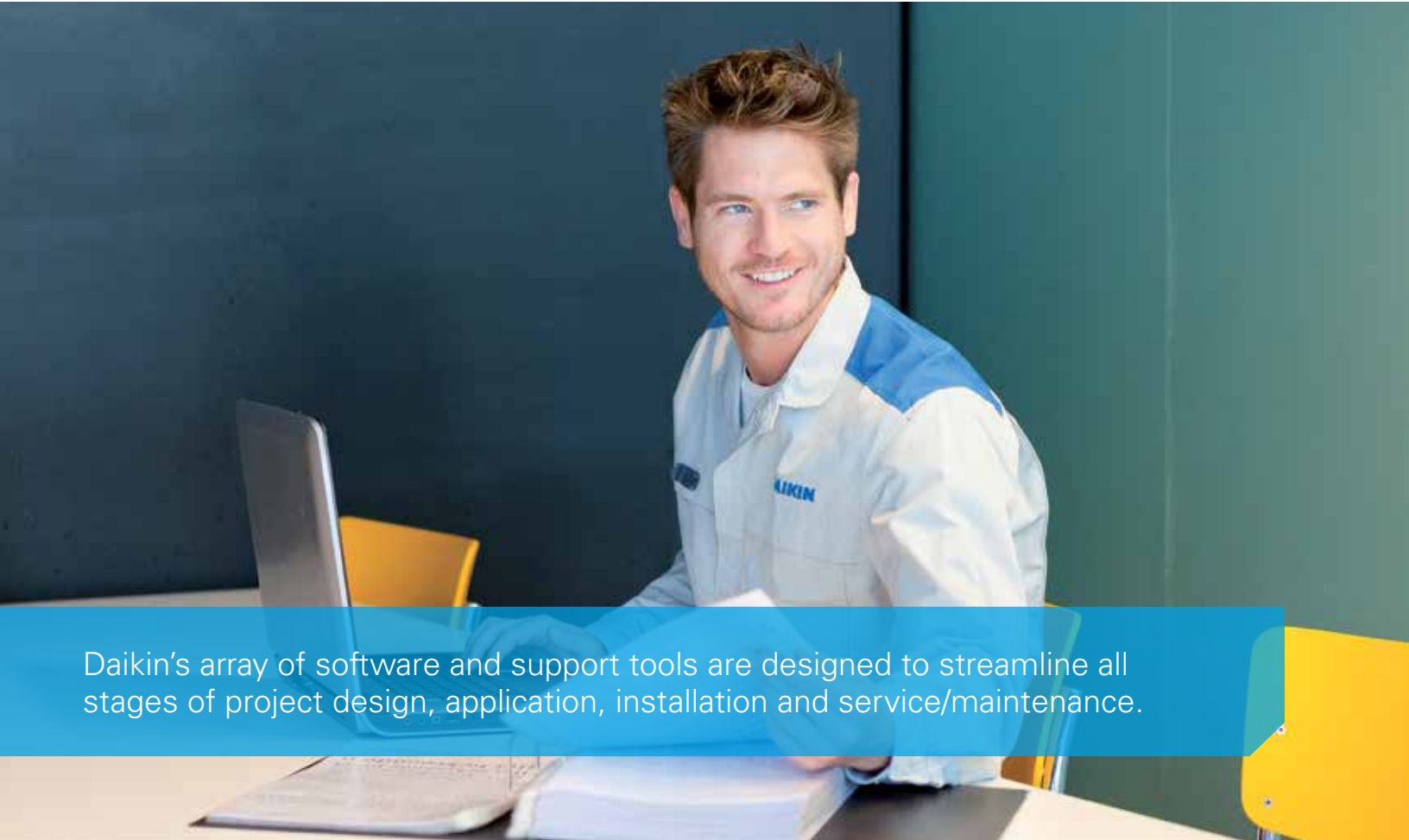













Daikin's array of software and support tools are designed to streamline all stages of project design, application, installation and service/maintenance.

Daikin provides multiple tools to aid the design, selection, analysis, submission, and general support for its line up of ductless, rooftop, light commercial split and specifically for the full line of Daikin *VRV* systems.

The tools have been designed to be simple to use, easily accessible and to address the various considerations and steps in the evolution of a residential or commercial project, aimed at helping the architect, consulting engineer, contractor, installation technician, and service company to enhance workflows and general project execution.

## Daikin VRV support and tools overview

CATEGORIES		TOOLS															
		WebXpress	Ventilation Xpress	Controls Configurator	Online Energy Calculator	IES-VE Daikin VRV plug-in	Performance curves for third-party energy simulation Programs	CAD drawings	Revit models	Reference Charge Calculator	Ventilation Rate Calculator	Daikin City (including Guide Specs, IOMS etc.)	Daikin eQuip application	Dr. Daikin	VRVConfigurator	Service Checker	Online Spare Parts Bank
 Selection		■	■	■													
 Energy screening and simulation					■	■	■										
 Design and verification								■	■	■	■						
 Online and tablet reference (spec, data, submittal)												■					
 Smartphone and mobile reference													■	■			
 After sales and service															■	■	■

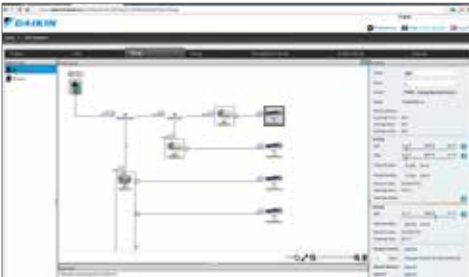

WebXpress

## Selection software

A key tool for Reps, Consulting Engineers and Contractors to use is the suite of **Xpress** selection software. These tools are web based and windows based EXE file designed to provide quick, easy and above all accurate selections of *VRV* systems and ventilation devices. Inputs can be customized to meet a variety of project needs and has the following features and benefits:

- » Fully array of software configuration settings
- » Select and customize indoor unit types with options/accessories
- » Optimize condensing unit selections based on block load characteristics
- » Define pipe sizes and lengths and both local and centralized wiring schemes
- » Define and generate selection reports in Word (DOC), Excel (XLS), or CAD (DXF) formats

As controls for variable refrigerant flow system systems become much more sophisticated at both a zone and building level, ensuring the full array of features are captured, Daikin has developed a simple **controls configurator tool** allowing the consulting engineer or contractor to capture all of the features that are needed to be utilized with the suite of controls products from Daikin so to ensure that the commissioning engineer can then set-up and configure the system appropriately at start up.



IES-VE plug-in for Daikin *VRV*

## Energy screening and simulation tools

With the continued trend in looking at building costs beyond just the 1<sup>st</sup> cost, accurately screening or simulating the performance of systems in buildings at the conceptual stage is more important than ever. Daikin recognizes this need and has developed a variety of support tools for this purpose.

### Online *VRV* energy calculator

- » Easy access and registration via online.
- » Free of charge and easy to use.
- » Allows for a semi-dynamic energy screening to be completed for *VRV* only. Provides useful information such as part load curves, estimated annualized operating costs etc.

### IES-VE plug-in for Daikin *VRV*

- » One of the leading Energy Simulation programs in Europe is now gaining awareness and a growing user-base in North America.
- » With the Daikin *VRV* plug in for IES-VE you can take advantage of the enhanced energy simulation capabilities with the IES platform and combine in a fully validated modeling methodology for Daikin *VRV* systems including the innovative and energy saving “VRT” function. The results of the IES-VE simulations can be utilized for LEED, California Title 24 and other regulatory energy simulation requirements.

### » Performance curve/plug-ins for 3rd party modeling software

- » Daikin have developed curves, instructions and sample building files for a variety of other 3rd party energy simulation software programs such as:
  - eQuest
  - Energy Pro
  - Trace 700
  - Energy Plus (*VRV* HP only)
  - HAP



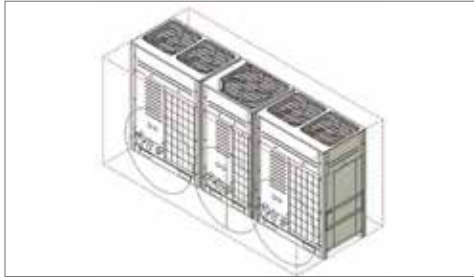

Revit



## Design and verification

Equipment Selection and Energy Simulation only reflect the early stages of a project evolution. At Daikin we recognize the importance of additionally providing resources to the Engineer and Architect community as well as contractors as follows:

- » **CAD** files for all products in multiple formats (DWG and DXF), etc.
- » **Revit** files for BIM architecture for all products
- » **Refrigerant Charge Calculator**
  - Quick check of the total refrigerant charge in a *VRV* System based on applied pipe-lengths and combination ratio's etc
  - Quick check of the minimum room volume (occupied space) that system charge can be utilized in per ASHRAE Standard 15-2010 and ASHRAE Standard 34-2010.
- » **Ventilation Rate Calculator**
  - Easy to use calculator to determine ventilation rates required for different room sizes and applications in accordance with ASHRAE Standard 62.1-2013.



www.DaikinCity.com



## Online and tablet reference material

**Daikin City** serves as the multi-functional portal for all disciplines interested in or already using Daikin products and technologies for a project. More than just a typical website, Daikin City provides:

- » Energy-saving characteristics of *VRV* systems in various vertical market buildings
- » Product videos and feature summaries via the communications center
- » A fully stocked library of information simply arranged for ease of finding any piece of Daikin information you may need such as IOM's, brochures, engineering data, and application guides etc (registration required).
- » Easy access to the suite of sales tools that Daikin offer (registration required).
- » An easy to use product specification library to quickly verify any spec item required, or to generate a submittal data sheet, guide spec or confirmation of the available accessories and options for a specific product (registration required).

## Support and Tools (cont.)



Daikin eEquip application



### Smartphone and mobile reference

» With the **Daikin eEquip application**, available for both iOS devices and Android devices, you can have the power of all Daikin product information and support material readily accessible on your mobile device or tablet.



[www.DrDaikin.com](http://www.DrDaikin.com)

» For rapid resolution to a system with an error code, or general troubleshooting needs, the **Dr. Daikin tool** is a helpful and quick reference tool that works via a standard desktop, tablet or smartphone and even SMS. When you need to understand or isolate the scope of one of Daikin's diagnostic codes, enter the code into the Dr. Daikin resource and automatically the tool will provide feedback of what the diagnostic code refers to and straightforward guidance on how to address the code.

Visit [www.drdaikin.com](http://www.drdaikin.com) for further information.



Daikin's tools and support enables consulting engineers, building owners and installers to optimize the life cycle cost of the *VRV* systems.



Daikin VRV Configurator



Daikin's online spare parts databank



## After sales and service

With a strong commitment to sales tools to help design and apply the product is equally supported with a strong commitment on after-sales and service tools aimed at the service contractor or maintenance technician.

- » **Daikin VRV Configurator** is a PC based software tool that allows an installing contractor to “set-up” the operating parameters and field settings of the VRV IV outdoor units off-site and then use a handy USB connection to upload those settings during the commissioning process. This helps save time and ensure that projects with multiple systems can be set up correctly and error free. The Configurator tool also allows for up to 48hrs of operation data from an installed system to be downloaded to a laptop computer for analysis if needed.
- » **Daikin VRV Service Checker** is a PC based software tool that facilitates a connection to the system and monitors all components of the system including temperatures, pressures, compressor and fan speeds, and may other items and can be utilized to understand operational trends with the system and what is happening in the system at a specific

time. This tool is very helpful when troubleshooting a system in the event of error or diagnostic notification.

- » **Daikin's online spare parts databank** (registration required) is an easy to use graphically driven means of identifying what spare or replacement part might be needed during the life cycle of the VRV equipment. Using this resource will help you identify the part number, applicable model, any alternative part options, and the availability of the part both locally and globally.
- » **Daikin University** offers Daikin's customers a variety of quality training programs designed to provide the tools and resources needed for our customers to be successful.
  - Our courses are designed by training professionals around specific objectives based on industry needs and job task analysis. We offer a choice of instructional settings based on the program goals and our students' needs including: online/on-demand web-based training, instructor led webinars, onsite training, and instructor-led classroom training at one of our many Daikin Authorized training facilities.









About Daikin:



Daikin Industries, Ltd. (DIL) is a global Fortune 1000 company which celebrated its 90th anniversary in May 2014. The company is recognized as one of the largest HVAC (Heating, Ventilation, Air Conditioning) manufacturers in the world. DIL is primarily engaged in developing indoor comfort systems and refrigeration products for residential, commercial and industrial applications. Its consistent success is derived, in part, from a focus on innovative, energy-efficient and premium quality indoor climate and comfort management solutions.



**WARNINGS:**

- » Always use a licensed installer or contractor to install this product. Do not try to install the product yourself. Improper installation can result in water or refrigerant leakage, electrical shock, fire or explosion.
- » Use only those parts and accessories supplied or specified by Daikin. Ask a licensed contractor to install those parts and accessories. Use of unauthorized parts and accessories or improper installation of parts and accessories can result in water or refrigerant leakage, electrical shock, fire or explosion.
- » Read the User's Manual carefully before using this product. The User's Manual provides important safety instructions and warnings. Be sure to follow these instructions and warnings.
- » For any inquiries, contact your local Daikin sales office.

**Additional Information**

Before purchasing this appliance, read important information about its estimated annual energy consumption, yearly operating cost, or energy efficiency rating that is available from your retailer.

Daikin, VRV, and their designs are trademarks owned by Daikin.



Our continuing commitment to quality products may mean a change in specifications without notice.

© 2019 **DAIKIN NORTH AMERICA LLC** · Houston, Texas · USA · [www.daikincomfort.com](http://www.daikincomfort.com) or [www.daikinac.com](http://www.daikinac.com)